

FEATURES

Complete 8-Bit DAC
Voltage Output—0 V to 2.56 V
Internal Precision Band-Gap Reference
Single-Supply Operation: +5 V ($\pm 10\%$)
Full Microprocessor Interface
Fast: 1 μ s Voltage Settling to $\pm 1/2$ LSB
Low Power: 75 mW
No User Trims Required
Guaranteed Monotonic Over Temperature
All Errors Specified T_{MIN} to T_{MAX}
Small 16-Pin DIP or 20-Pin PLCC Package
Low Cost

GENERAL DESCRIPTION

The AD557 DACPORT® is a complete voltage-output 8-bit digital-to-analog converter, including output amplifier, full microprocessor interface and precision voltage reference on a single monolithic chip. No external components or trims are required to interface, with full accuracy, an 8-bit data bus to an analog system.

The low cost and versatility of the AD557 DACPORT are the result of continued development in monolithic bipolar technologies.

The complete microprocessor interface and control logic is implemented with integrated injection logic (I^2L), an extremely dense and low-power logic structure that is process-compatible with linear bipolar fabrication. The internal precision voltage reference is the patented low-voltage band-gap circuit which permits full-accuracy performance on a single +5 V power supply. Thin-film silicon-chromium resistors provide the stability required for guaranteed monotonic operation over the entire operating temperature range, while laser-wafer trimming of these thin-film resistors permits absolute calibration at the factory to within ± 2.5 LSB; thus, no user-trims for gain or offset are required. A new circuit design provides voltage settling to $\pm 1/2$ LSB for a full-scale step in 800 ns.

The AD557 is available in two package configurations. The AD557JN is packaged in a 16-pin plastic, 0.3"-wide DIP. For surface mount applications, the AD557JP is packaged in a 20-pin JEDEC standard PLCC. Both versions are specified over the operating temperature range of 0°C to +70°C.

DACPORT is a registered trademark of Analog Devices, Inc.

Covered by U.S. Patent Nos. 3,887,863; 3,685,045; 4,323,795; other patents pending.

REV. A

Information furnished by Analog Devices is believed to be accurate and reliable. However, no responsibility is assumed by Analog Devices for its use, nor for any infringements of patents or other rights of third parties which may result from its use. No license is granted by implication or otherwise under any patent or patent rights of Analog Devices.

FUNCTIONAL BLOCK DIAGRAM

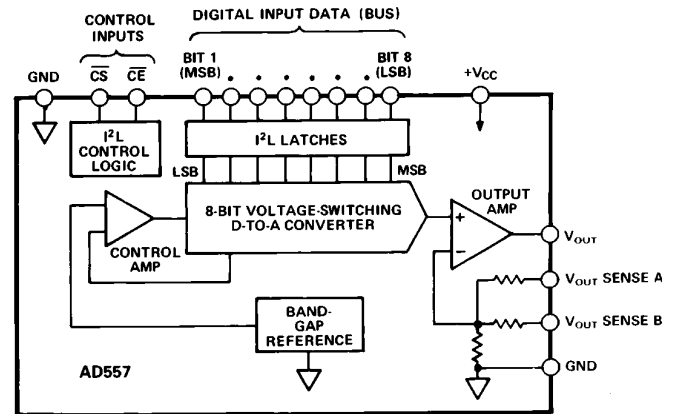

PRODUCT HIGHLIGHTS

1. The 8-bit I^2L input register and fully microprocessor-compatible control logic allow the AD557 to be directly connected to 8- or 16-bit data buses and operated with standard control signals. The latch may be disabled for direct DAC interfacing.
2. The laser-trimmed on-chip SiCr thin-film resistors are calibrated for absolute accuracy and linearity at the factory. Therefore, no user trims are necessary for full rated accuracy over the operating temperature range.
3. The inclusion of a precision low-voltage band-gap reference eliminates the need to specify and apply a separate reference source.
4. The AD557 is designed and specified to operate from a single +4.5 V to +5.5 V power supply.
5. Low digital input currents, 100 μ A max, minimize bus loading. Input thresholds are TTL/low voltage CMOS compatible.
6. The single-chip, low power I^2L design of the AD557 is inherently more reliable than hybrid multichip or conventional single-chip bipolar designs.

AD557—SPECIFICATIONS (@ $T_A = +25^\circ\text{C}$, $V_{CC} = +5\text{ V}$ unless otherwise noted)

Model	Min	Typ	Max	Units
RESOLUTION			8	Bits
RELATIVE ACCURACY 0 to +70°C		$\pm 1/2$	1	LSB
OUTPUT Ranges Current Source Sink	+5	0 to +2.56 Internal Passive Pull-Down to Ground ²		V mA
OUTPUT SETTling TIME ³		0.8	1.5	μs
FULL-SCALE ACCURACY ⁴ @ +25°C T_{MIN} to T_{MAX}		± 1.5 ± 2.5	± 2.5 ± 4.0	LSB LSB
ZERO ERROR @ +25°C T_{MIN} to T_{MAX}			± 1 ± 3	LSB LSB
MONOTONICITY ⁵ T_{MIN} to T_{MAX}		Guaranteed		
DIGITAL INPUTS T_{MIN} to T_{MAX} Input Current			± 100	μA
Data Inputs, Voltage Bit On—Logic “1” Bit On—Logic “0”	2.0 0		0.8	V V
Control Inputs, Voltage On—Logic “1” On—Logic “0”	2.0 0		0.8	V V
Input Capacitance		4		pF
TIMING ⁶ t_w Strobe Pulse Width T_{MIN} to T_{MAX} t_{DH} Data Hold Time T_{MIN} to T_{MAX} t_{DS} Data Setup Time T_{MIN} to T_{MAX}	225 300 10 10 225 300			ns ns ns ns ns ns
POWER SUPPLY Operating Voltage Range (V_{CC}) 2.56 Volt Range Current (I_{CC}) Rejection Ratio	+4.5	15	+5.5 25 0.03	V mA %/%
POWER DISSIPATION, $V_{CC} = 5\text{ V}$		75	125	mW
OPERATING TEMPERATURE RANGE	0		+70	°C

NOTES

¹Relative Accuracy is defined as the deviation of the code transition points from the ideal transfer point on a straight line from the zero to the full scale of the device.

²Passive pull-down resistance is 2 k Ω .

³Settling time is specified for a positive-going full-scale step to $\pm 1/2$ LSB. Negative-going steps to zero are slower, but can be improved with an external pull-down.

⁴The full-scale output voltage is 2.55 V and is guaranteed with a +5 V supply.

⁵A monotonic converter has a maximum differential linearity error of ± 1 LSB.

⁶See Figure 7.

Specifications subject to change without notice.

ABSOLUTE MAXIMUM RATINGS*

V_{CC} to Ground 0 V to +18 V

Digital Inputs (Pins 1–10) 0 V to +7.0 V

V_{OUT} Indefinite Short to Ground
Momentary Short to V_{CC}

Power Dissipation 450 mW

Storage Temperature Range

N/P (Plastic) Packages -25°C to +100°C

Lead Temperature (Soldering, 10 sec) 300°C

Thermal Resistance

Junction to Ambient/Junction to Case

N/P (Plastic) Packages 140/55°C/W

*Stresses above those listed under “Absolute Maximum Ratings” may cause permanent damage to the device. This is a stress rating only and functional operation of the device at these or any other conditions above those indicated in the operational section of this specification is not implied. Exposure to absolute maximum rating conditions for extended periods may affect device reliability.

PIN CONFIGURATIONS

DIP

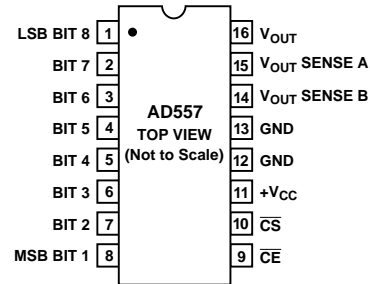

PLCC

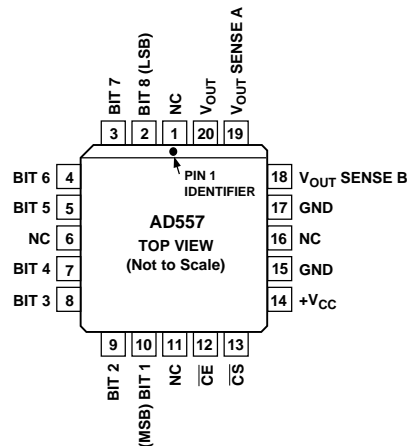

NC = NO CONNECT

ORDERING GUIDE

Model	Temperature Range	Package Option*
AD557JN	0°C to +70°C	N-16
AD557JP	0°C to +70°C	P-20A

*N = Plastic DIP; P = Plastic Leaded Chip Carrier.

CIRCUIT DESCRIPTION

The AD557 consists of four major functional blocks fabricated on a single monolithic chip (see Figure 1). The main D/A converter section uses eight equally weighted laser-trimmed current sources switched into a silicon-chromium thin-film R/2R resistor ladder network to give a direct but unbuffered 0 mV to 400 mV output range. The transistors that form the DAC switches are PNPs; this allows direct positive-voltage logic interface and a zero-based output range.

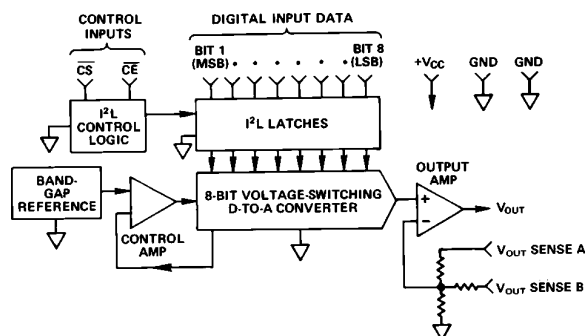

Figure 1. Functional Block Diagram

The high-speed output buffer amplifier is operated in the noninverting mode with gain determined by the user-connections at the output range select pin. The gain-setting application resistors are thin film laser trimmed to match and track the DAC resistors and to assure precise initial calibration of the output range, 0 V to 2.56 V. The amplifier output stage is an NPN transistor with passive pull-down for zero-based output capability with a single power supply.

The internal precision voltage reference is of the patented band-gap type. This design produces a reference voltage of 1.2 V and thus, unlike 6.3 V temperature-compensated Zeners, may be operated from a single, low-voltage logic power supply. The microprocessor interface logic consists of an 8-bit data latch and control circuitry. Low power, small geometry and high speed are advantages of the I²L design as applied to this section. I²L is bipolar process compatible so that the performance of the analog sections need not be compromised to provide on-chip logic capabilities. The control logic allows the latches to be operated from a decoded microprocessor address and write signal. If the application does not involve a μ P or data bus, wiring \overline{CS} and \overline{CE} to ground renders the latches "transparent" for direct DAC access.

Digital Input Code			Output Voltage
Binary	Hexadecimal	Decimal	
0000 0000	00	0	0
0000 0001	01	1	0.010 V
0000 0010	02	2	0.020 V
0000 1111	0F	15	0.150 V
0001 0000	10	16	0.160 V
0111 1111	7F	127	1.270 V
1000 0000	80	128	1.280 V
1100 0000	C0	192	1.920 V
1111 1111	FF	255	2.55 V

CONNECTING THE AD557

The AD557 has been configured for low cost and ease of application. All reference, output amplifier and logic connections are made internally. In addition, all calibration trims are performed at the factory assuring specified accuracy without user trims. The only connection decision to be made by the user is whether the output range desired is unipolar or bipolar. Clean circuit board layout is facilitated by isolating all digital bit inputs on one side of the package; analog outputs are on the opposite side.

UNIPOLAR 0 V TO +2.56 V OUTPUT RANGE

Figure 2 shows the configuration for the 0 V to +2.56 V full-scale output range. Because of its precise factory calibration, the AD557 is intended to be operated without user trims for gain

and offset; therefore, no provisions have been made for such user trims. If a small increase in scale is required, however, it may be accomplished by slightly altering the effective gain of the output buffer. A resistor in series with V_{OUT} SENSE will increase the output range. Note that decreasing the scale by putting a resistor in series with GND will not work properly due to the code-dependent currents in GND. Adjusting offset by injecting dc at GND is not recommended for the same reason.

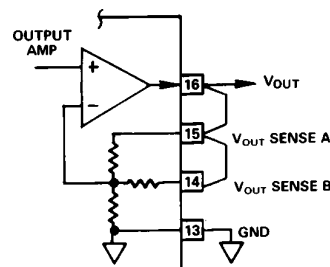

Figure 2. 0 V to 2.56 V Output Range

BIPOLAR -1.28 V TO +1.28 V OUTPUT RANGE

The AD557 was designed for operation from a single power supply and is thus capable of providing only a unipolar 0 V to +2.56 V output range. If a negative supply is available, bipolar output ranges may be achieved by suitable output offsetting and scaling. Figure 3 shows how a ± 1.28 V output range may be achieved when a -5 V power supply is available. The offset is provided by the AD589 precision 1.2 V reference which will operate from a +5 V supply. The AD711 output amplifier can provide the necessary ± 1.28 V output swing from ± 5 V supplies. Coding is complementary offset binary.

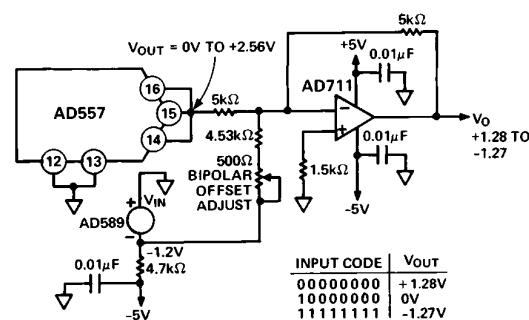

Figure 3. Bipolar Operation of AD557 from ± 5 V Supplies

Applications

GROUNDING AND BYPASSING

All precision converter products require careful application of good grounding practices to maintain full rated performance. Because the AD557 is intended for application in microcomputer systems where digital noise is prevalent, special care must be taken to assure that its inherent precision is realized.

The AD557 has two ground (common) pins; this minimizes ground drops and noise in the analog signal path. Figure 4 shows how the ground connections should be made.

It is often advisable to maintain separate analog and digital grounds throughout a complete system, tying them common in one place only. If the common tie-point is remote and accidental disconnection of that one common tie-point occurs due to card removal with power on, a large differential voltage between the

AD557

two commons could develop. To protect devices that interface to both digital and analog parts of the system, such as the AD557, it is recommended that common ground tie-points should be provided at *each* such device. If only one system ground can be connected directly to the AD557, it is recommended that analog common be selected.

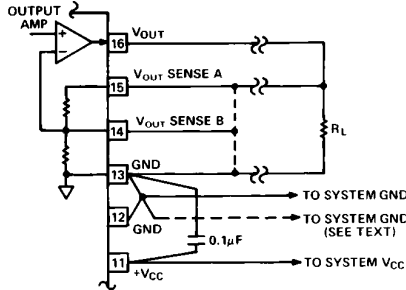

Figure 4. Recommended Grounding and Bypassing

USING A "FALSE" GROUND

Many applications, such as disk drives, require servo control voltages that swing on either side of a "false" ground. This ground is usually created by dividing the +12 V supply equally and calling the midpoint voltage "ground."

Figure 5 shows an easy and inexpensive way to implement this. The AD586 is used to provide a stable 5 V reference from the system's +12 V supply. The op amp shown likewise operates from a single (+12 V) supply available in the system. The resulting output at the V_{OUT} node is ± 2.5 V around the "false" ground point of 5 V. AD557 input code vs. V_{OUT} is shown in Figure 6.

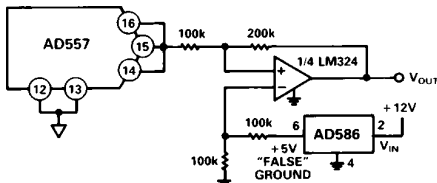

Figure 5. Level Shifting the AD557 Output Around a "False" Ground

TIMING AND CONTROL

The AD557 has data input latches that simplify interface to 8- and 16-bit data buses. These latches are controlled by Chip Enable (\overline{CE}) and Chip Select (\overline{CS}) inputs. \overline{CE} and \overline{CS} are internally "NORed" so that the latches transmit input data to the DAC section when both \overline{CE} and \overline{CS} are at Logic "0". If the application does not involve a data bus, a "00" condition allows for direct operation of the DAC. When either \overline{CE} or \overline{CS} go to Logic "1," the input data is latched into the registers and held until both \overline{CE} and \overline{CS} return to "0." (Unused \overline{CE} or \overline{CS} inputs should be tied to ground.) The truth table is given in Table I. The logic function is also shown in Figure 6.

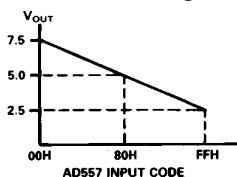

Figure 6. AD557 Input Code vs. Level Shifted Output in a "False" Ground Configuration

Table I. AD557 Control Logic Truth Table

Input Data	\overline{CE}	\overline{CS}	DAC Data	Latch Condition
0	0	0	0	"transparent"
1	0	0	1	"transparent"
0	g	0	0	latching
1	g	0	1	latching
0	0	g	0	latching
1	0	g	1	latching
X	1	X	previous data	latched
X	X	1	previous data	latched

NOTES

X = Does not matter

g = Logic Threshold at Positive-Going Transition

In a level-triggered latch such as that used in the AD557, there is an interaction between the data setup and hold times and the width of the enable pulse. In an effort to reduce the time required to test all possible combinations in production, the AD557 is tested with $T_{DS} = T_W = 225$ ns at 25°C and 300 ns at T_{MIN} and T_{MAX} , with $T_{DH} = 10$ ns at all temperatures. Failure to comply with these specifications may result in data not being latched properly.

Figure 7 shows the timing for the data and control signals, \overline{CE} and \overline{CS} are identical in timing as well as in function.

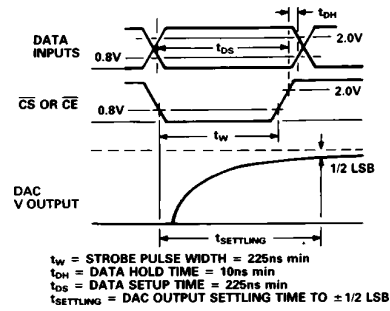
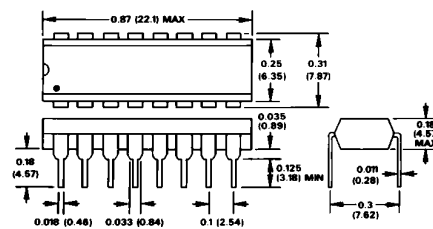

Figure 7. AD557 Timing

OUTLINE DIMENSIONS

Dimensions shown in inches and (mm).

N (Plastic) Package



P (PLCC) Package

