

DATA SHEET

TDA3857

Quasi-split sound processor with
two FM demodulators

Product specification
File under Integrated Circuits, IC02

June 1994

Quasi-split sound processor with two FM demodulators

TDA3857

FEATURES

- Quasi-split sound processor for all FM standards e. g. B/G
- Reducing of spurious video signals by tracking function and AFC for the vision carrier reference circuit; (recommended for NICAM)
- Automatic muting of the AF2 signal by the input level
- Stereo matrix correction
- Layout-compatible with TDA3856 (24 pins) and TDA3858 (32 pins).

GENERAL DESCRIPTION

Symmetrical IF inputs. Gain controlled wideband IF amplifier.

AGC generation due to peak sync. Reference amplifier for the regeneration of the vision carrier. Optimized limiting amplifier for AM suppression in the regenerated vision carrier signal and 90° phase shifter.

Intercarrier mixer for FM sound, output with low-pass filter.

Separate signal processing for 5.5 and 5.74 MHz intercarriers. Wide supply voltage range, only 300 mW power dissipation at 5 V.

QUICK REFERENCE DATA

SYMBOL	PARAMETER	MIN.	TYP.	MAX.	UNIT
V_P	supply voltage (pin 19)	4.5	5	8.8	V
I_P	supply current	–	60	72	mA
$V_{i\text{ IF}}$	IF input sensitivity (–3 dB)	–	70	100	μV
$V_{o\text{ AF}}$	audio output signal (RMS value)	–	1	–	V
THD	total harmonic distortion	–	0.5	–	%
S/N (W)	weighted signal-to-noise ratio	–	68	–	dB

ORDERING INFORMATION

EXTENDED TYPE NUMBER	PACKAGE			
	PINS	PIN POSITION	MATERIAL	CODE
TDA3857	20	DIL	plastic	SOT146 ⁽¹⁾

Note

1. SOT 146-1; 1996 November 28.

Quasi-split sound processor with two FM demodulators

TDA3857

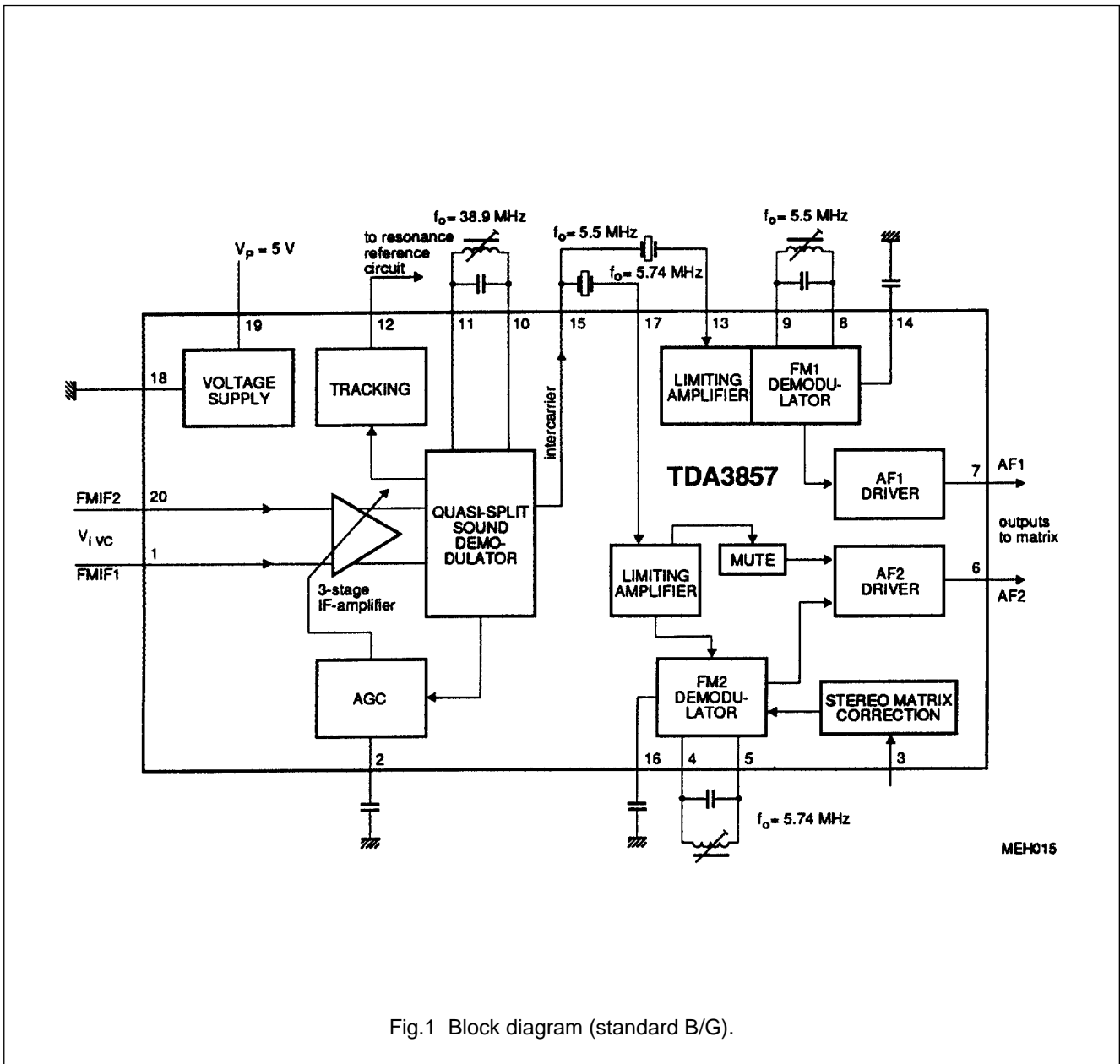

Fig.1 Block diagram (standard B/G).

Quasi-split sound processor with two FM demodulators

TDA3857

PINNING

SYMBOL	PIN	DESCRIPTION
FMIF1	1	IF difference input 1 for B/G standard (38.9 MHz)
C _{AGC}	2	charge capacitor for AGC
MATR	3	input for stereo matrix correction
FM2R1	4	reference circuit for FM2 (5.74 MHz)
FM2R2	5	reference circuit for FM2 (5.74 MHz)
AF2	6	AF2 output (AF out of 5.74 MHz)
AF1	7	AF1 output (AF out of 5.5 MHz)
FM1R1	8	reference circuit for FM1 (5.5 MHz)
FM1R2	9	reference circuit for FM1 (5.5 MHz)
VC-R1	10	reference circuit for the vision carrier (38.9 MHz)
VC-R2	11	reference circuit for the vision carrier (38.9 MHz)
TRACK	12	DC output level for tracking
FM1I	13	intercarrier input for FM1 (5.5 MHz)
C _{AF1}	14	DC decoupling capacitor for FM1 demodulator (AF1)
ICO	15	intercarrier output signal (5.5/5.74 MHz)
C _{AF2}	16	DC decoupling capacitor for FM2 demodulator (AF2)
FM2I	17	intercarrier input for FM2 (5.74 MHz)
GND	18	ground (0 V)
V _P	19	+5 to +8 V supply voltage
FMIF2	20	IF difference input 2 for B/G standard (38.9 MHz)

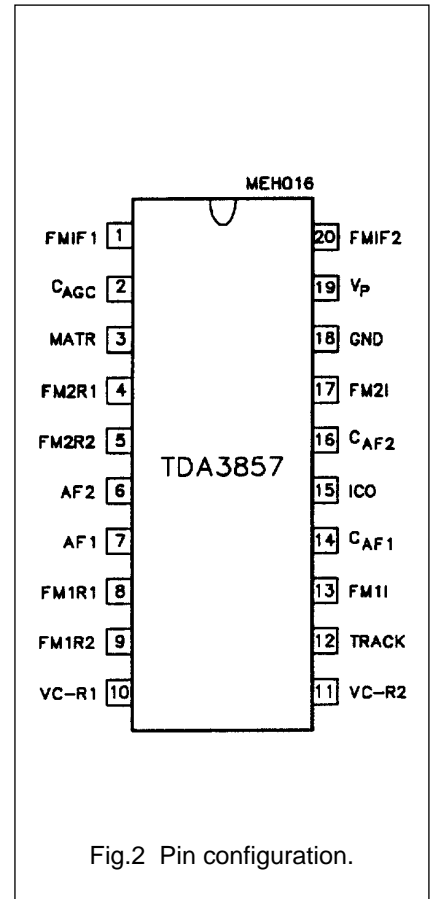

Fig.2 Pin configuration.

Quasi-split sound processor with two FM demodulators

TDA3857

FUNCTIONAL DESCRIPTION

The quasi-split sound processor is suitable for all FM standards (e. g. B/G).

B/G standard

AGC detector uses peak sync level. Sound carrier SC1 (5.5 MHz) provides AF1, sound carrier SC2 (5.74 MHz) provides AF2.

Muting

With no sound carrier SC2 at pin 17, AF2 output is muted. The mute circuit prevents false signal recognition in the stereo decoder at high IF signal levels when no second sound carrier exists (mono) and an AF signal is present in the identification signal frequency range.

With 1 mV at pin 17, under measurement conditions, AF2 is switched on (see limiting amplifier). Weak input signals at pins 1 and 20 generate noise at pin 17, which is present in the intercarrier signal and passes through the 5.74 MHz filter. Noise at pin 17 inhibits muting. No misinterpretation due to white noise occurs in the stereo decoder, when non-correlated noise masks the identification signal frequencies, which may be present in sustained tone signals. The stereo decoder remains switched to mono.

Sound carrier notch filter for an improved intercarrier buzz

The series capacitor C_s in the 38.9 MHz resonant circuit provides a notch at the sound carrier frequency in order to provide more attenuation for the sound carrier in the vision carrier reference channel. The ratio of parallel/series capacitor depends on the ratio of VC/SC frequency and

has to be adapted to other TV transmission standards if necessary, according to the formula

$$C_s = C_p (f_{vc}/f_{sc})^2 - C_p$$

The result is an improved intercarrier buzz (up to 10 dB improvement in sound channel 2 with 250 kHz video modulation for B/G stereo) or suppression of 350 kHz video modulated beat frequency in the digitally-modulated NICAM subcarrier.

Intercarrier buzz fine tuning with 250 kHz square wave video modulation

The picture carrier for quadrature demodulation in the intercarrier mixer is not exactly 90 degrees due to the shift variation in the integrated phase shift network. The tuning of the LC reference circuit to provide optimal video suppression at the intercarrier output is not the same as that to provide optimal intercarrier buzz suppression. In order to optimize the AF signal performance, a fine tuning for the optimal S/N at the sound channel 2 (from 5.74 MHz) may be performed with a 250 kHz square wave video modulation.

Measurements at the demodulators

For all signal-to-noise measurements the generator must meet the following specifications:

phase modulation errors $< 0.5^\circ$ for B/W-jumps intercarrier signal-to-noise ratio as measured with 'TV-demodulator AMF2' (weighted S/N) must be > 60 dB at 6 kHz sine wave modulation of the B/W-signal.

Signal-to-noise ratios are measured with $\Delta f = \pm 50$ kHz deviation and $f_{mod} = 1$ kHz; with a deviation of ± 30 kHz the S/N ratio is deteriorated by 4.5 dB.

Quasi-split sound processor with two FM demodulators

TDA3857

LIMITING VALUES

In accordance with the Absolute Maximum Rating System (IEC 134).

SYMBOL	PARAMETER	MIN.	MAX.	UNIT
V _P	supply voltage (pin 19)	–	8.8	V
V _I	voltage (pins 1, 6, 7, 13, 15, 17 and 20)	0	V _P	V
P _{tot}	total power dissipation	0	635	mW
T _{stg}	storage temperature	–25	+150	°C
T _{amb}	operating ambient temperature	0	+70	°C
V _{ESD}	electrostatic handling (note 1)			
	all pins except pins 1 and 20	±500	–	V
	pins 1 and 20	+400	–	V
		–500	–	V

Note to the Limiting Values

- Equivalent to discharging a 200 pF capacitor through a 0 Ω series resistor.

CHARACTERISTICS

V_P = 5 V and T_{amb} = +25 °C; measurements taken in Fig.3 with f_{VC} = 38.9 MHz, f_{SC1} = 33.4 MHz and f_{SC2} = 33.158 MHz. Vision carrier (VC) modulated with different video signals, modulation depth 100% (proportional to 10% residual carrier).

Vision carrier amplitude (RMS value) V_{i VC} = 10 mV; vision to sound carrier ratios are VC/SC1 = 13 dB and VC/SC2 = 20 dB. Sound carriers (SC1, SC2) modulated with f = 1 kHz and deviation Δf = 50 kHz, unless otherwise specified.

SYMBOL	PARAMETER	CONDITIONS	MIN.	TYP.	MAX.	UNIT
V _P	supply voltage (pin 19)		4.5	5	8.8	V
I _P	supply current (pin 19)		48	60	72	mA
IF amplifier (pins 1 and 20)						
R _I	input resistance		1.8	2.2	–	kΩ
C _I	input capacitance		–	2.0	2.6	pF
V _I	DC input voltage		–	1.75	–	V
V _{i IF (RMS)}	maximum input signal (RMS value, pins 1-20)	V _o = +1 dB	70	100	–	mV
	input signal sensitivity (RMS value)	–3 dB intercarrier signal reduction at pin 15	–	70	100	μV
ΔG _v	IF gain control		60	63	–	dB
V ₂	voltage for gain control (pin 2)		1.7	–	2.6	V
B	IF bandwidth	–3 dB	50	70	–	MHz
Resonance amplifier (pins 10-11)						
V _{o (p-p)}	vision carrier amplitude (peak-to-peak value)	f _o = 38.9 MHz	–	270	–	mV
R ₁₀₋₁₁	operating resistance		–	4	–	kΩ
L	inductance	Figs 3 and 4	–	0.247	–	μH
C	capacitance		–	68	–	pF

Quasi-split sound processor with two FM demodulators

TDA3857

SYMBOL	PARAMETER	CONDITIONS	MIN.	TYP.	MAX.	UNIT
Q_L	Q-factor of resonance circuit	$Q_0 = 90$	–	40	–	
$V_{10, 11}$	DC voltage (pins 10 and 11)		–	$V_P - 1$	–	V
Intercarrier mixer output (pin 15)						
V_o (RMS)	output signal for 5.5 MHz (RMS value)		71	95	125	mV
	output signal for 5.74 MHz (RMS value)		32	43	56	mV
B	IF bandwidth	–1 dB	6	8.5	–	MHz
		–3 dB	7	10	–	MHz
V_{VID}/V_{15}	residual video AM on intercarrier	note 1	–	3	10	%
V_{VC} (RMS)	residual vision carrier (RMS value)	1st/2nd harmonic (38.9/77.8 MHz)	–	0.5	1	mV
R_{15}	output resistance (emitter follower)	1 mA emitter current	–	30	–	Ω
I_o	allowable AC output current (pin 15)		–	–	± 0.7	mA
I_{15}	allowable DC output current		–	–	–2	mA
V_{15}	DC voltage	LC-circuit at pin 10, 11 adjusted to minimum video content at pin 15	1.5	1.75	2.0	V
Limiting amplifiers (pins 13 and 17)						
V_i (RMS)	minimum input signal (RMS value)	–3 dB AF signal	–	300	450	μ V
	maximum input signal (RMS value)		200	–	–	mV
$R_{13, 17}$	input resistance		450	560	700	Ω
$V_{13, 17}$	DC voltage		–	0	–	V
V_i (RMS)	level detector threshold for no muting (RMS value, pin 17)	only 5.74 MHz channel	0.8	1.2	1.7	mV
ΔV_i	hysteresis of level detector		4	7	12	dB
FM1 and FM2 demodulators						
Measurements with FM IF input signals of 5.5 MHz and 5.74 MHz with $V_{i\ IF}$ (RMS) = 10 mV ($f_{mod} = 1$ kHz, deviation $\Delta f = \pm 50$ kHz) at pins 13 and 17 without ceramic filters, $R_s = 50 \Omega$. De-emphasis 50 μ s. Q_L -factor = 11 for resonant circuits at pins 4-5 and 8-9 (including IC).						
V_{IC} (RMS)	intercarrier signals (RMS values, pins 4-5 and 8-9)		–	100	–	mV
V	DC voltage (pins 4, 5, 8 and 9)		–	1.8	–	V
V_o (RMS)	AF output signals (RMS values, pins 6 and 7)		0.84	0.95	1.07	V
ΔV_o	difference of AF signals between channels (pins 6 and 7)	note 2	–	–	1	dB
$R_{6, 7}$	output resistance		75	100	130	Ω
$V_{6, 7}$	DC voltage		1.8	2.1	2.4	V

Quasi-split sound processor with two FM demodulators

TDA3857

SYMBOL	PARAMETER	CONDITIONS	MIN.	TYP.	MAX.	UNIT
AF performance for FM operation (standard B/G)						
input signals: B/G IF input signal (pin 1, 20) unmodulated sound carriers different video modulation (100%) the output signals are related to the signals described in the demodulator part.						
(S+N)/N(W)	weighted signal-to-noise ratio	CCIR468-3; de-emphasis 50 μ s				
	black picture	$f_i = 5.5$ MHz	59	63	–	dB
	2T/20T pulses with white bar	$f_i = 5.5$ MHz	57	61	–	dB
	6 kHz sine wave, B/W-modulated	$f_i = 5.5$ MHz	52	56	–	dB
	250 kHz square wave, B/W-modulated	$f_i = 5.5$ MHz	50	54	–	dB
	black picture	$f_i = 5.742$ MHz	57	61	–	dB
	2T/20T pulses with white bar	$f_i = 5.742$ MHz	55	59	–	dB
	6 kHz sine wave, B/W-modulated	$f_i = 5.742$ MHz	50	54	–	dB
	250 kHz square wave, B/W-modulated	$f_i = 5.742$ MHz	48	52	–	dB
Ripple rejection of the AF outputs						
RR	ripple rejection $V_{\text{ripple on } V_P} / V_{\text{ripple on } V_{\text{out}}}$	$V_{R(p-p)} = 200$ mV; $f_R = 70$ Hz	30	40	–	dB

Notes to the characteristics

- Spurious intercarrier AM: $M = (A - B)/A$ (A = signal at sync; B = signal with 100% picture modulation).
- AF signal can be adjusted by V_3 .
- For larger current: $R_L > 2.2$ k Ω (pin 6 or 7 to GND) in order to increase the bias current of the output emitter follower.
- If not used, pin 3 should not be connected.
- Automatic Frequency Control (AFC) of the vision carrier reference circuit (pins 10 and 11) for reducing spurious video signals in the stereo/dual sound modes. The factor of reducing F_{TR} at deviation Δf_{VC} specifies the ratio of spurious signals with/without tracking function.

Quasi-split sound processor with two FM demodulators

TDA3857

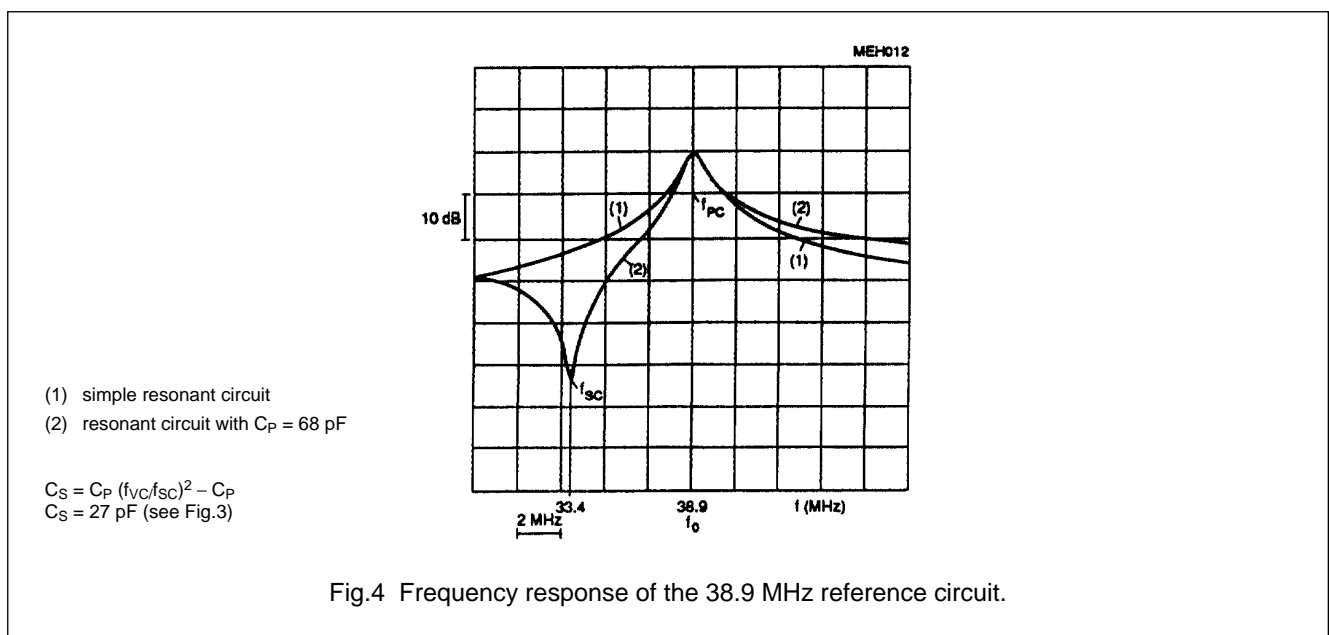
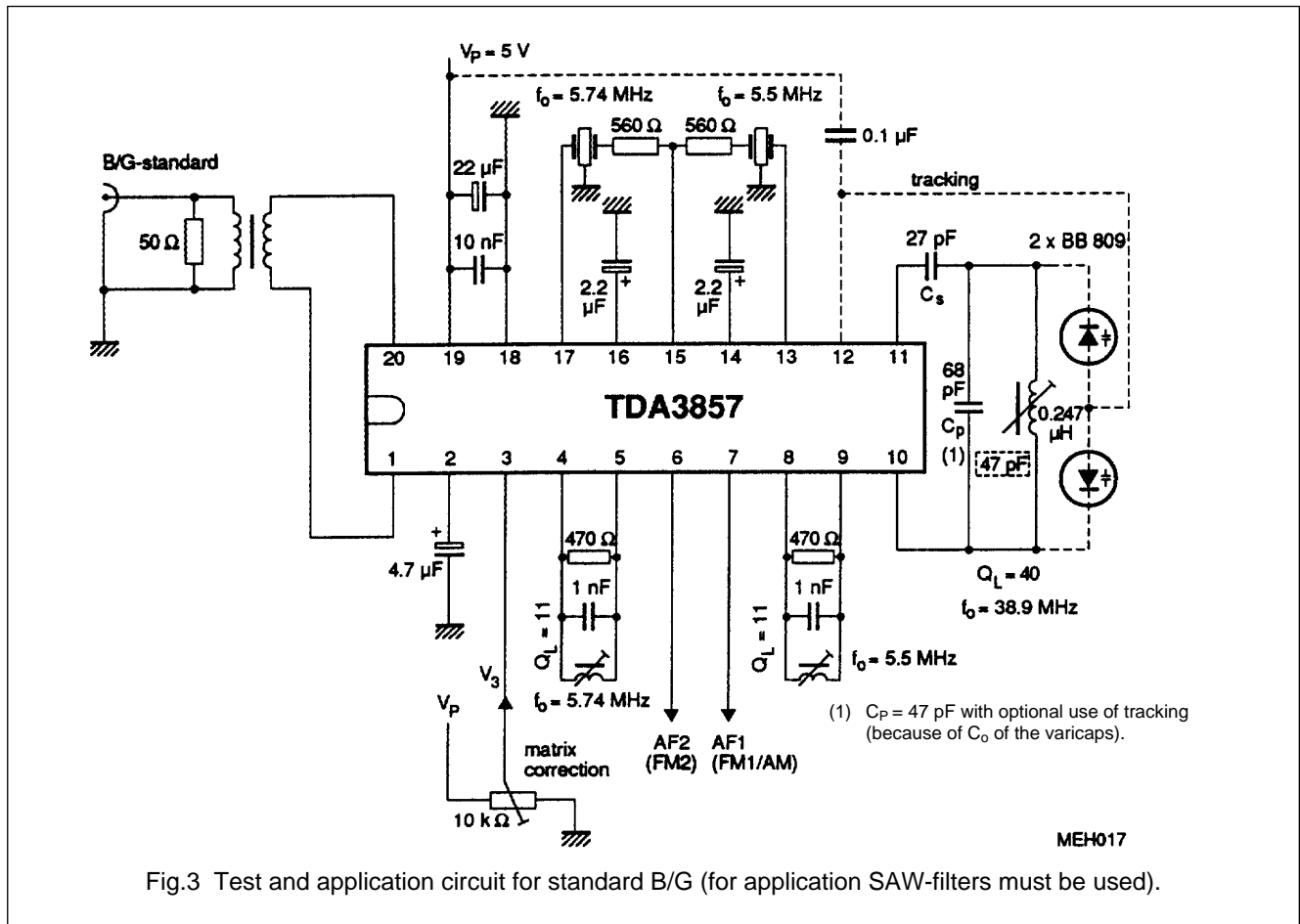

Quasi-split sound processor with two FM demodulators

TDA3857

APPLICATION INFORMATION

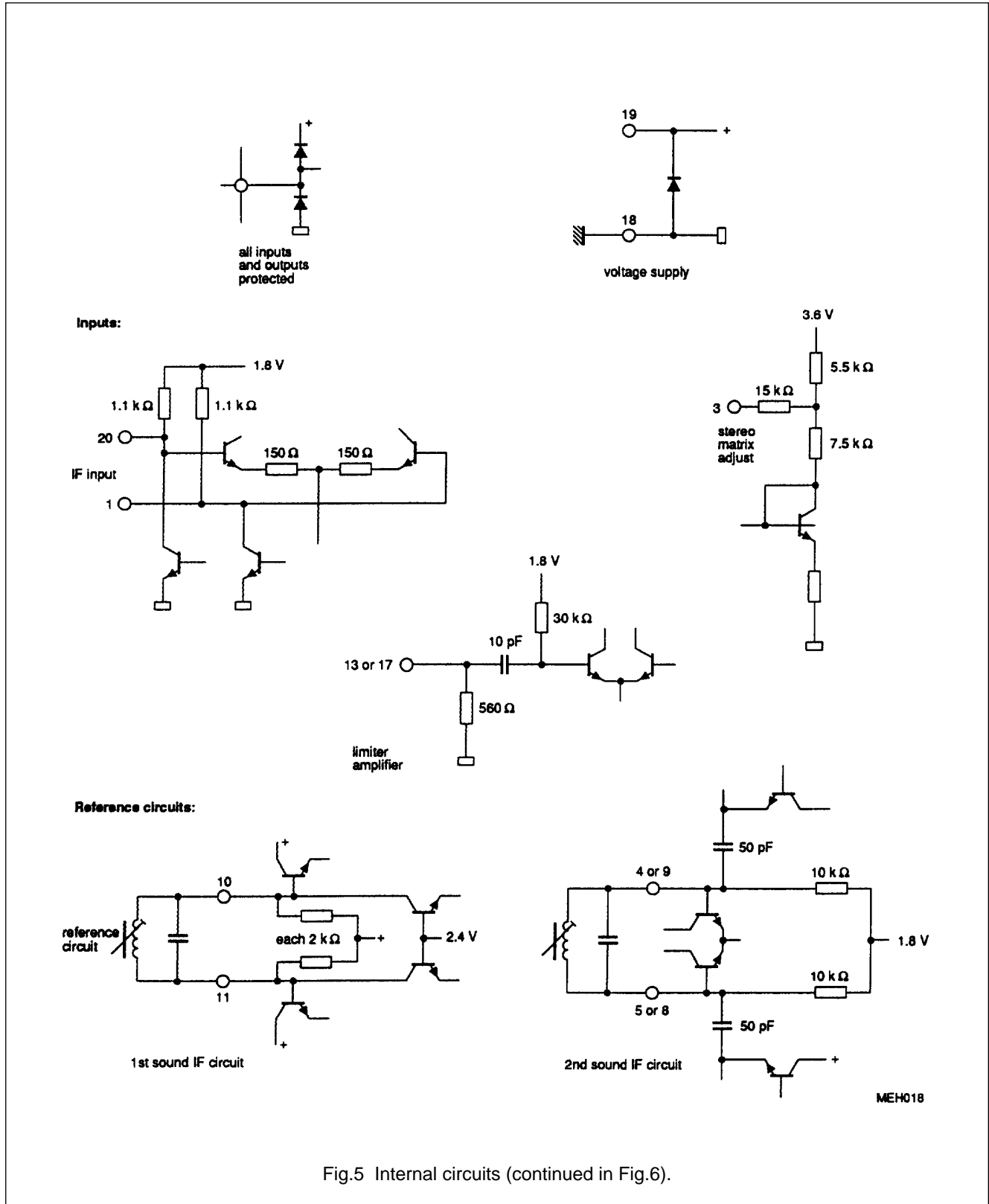
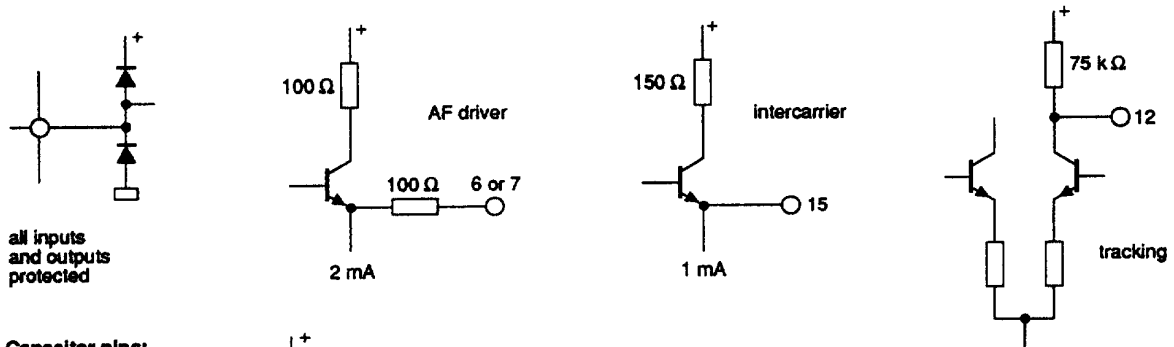

Fig.5 Internal circuits (continued in Fig.6).

Quasi-split sound processor with two FM demodulators

TDA3857

Driver outputs and decouplings:



Capacitor pins:

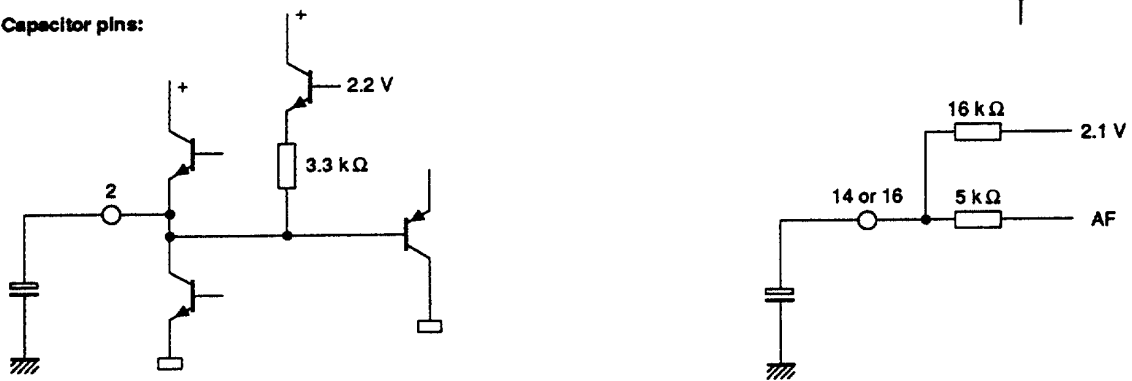

MEH019

Fig.6 Internal circuits (continued from Fig.5).

Quasi-split sound processor with two FM demodulators

TDA3857

PACKAGE OUTLINE

DIP20: plastic dual in-line package; 20 leads (300 mil)

SOT146-1

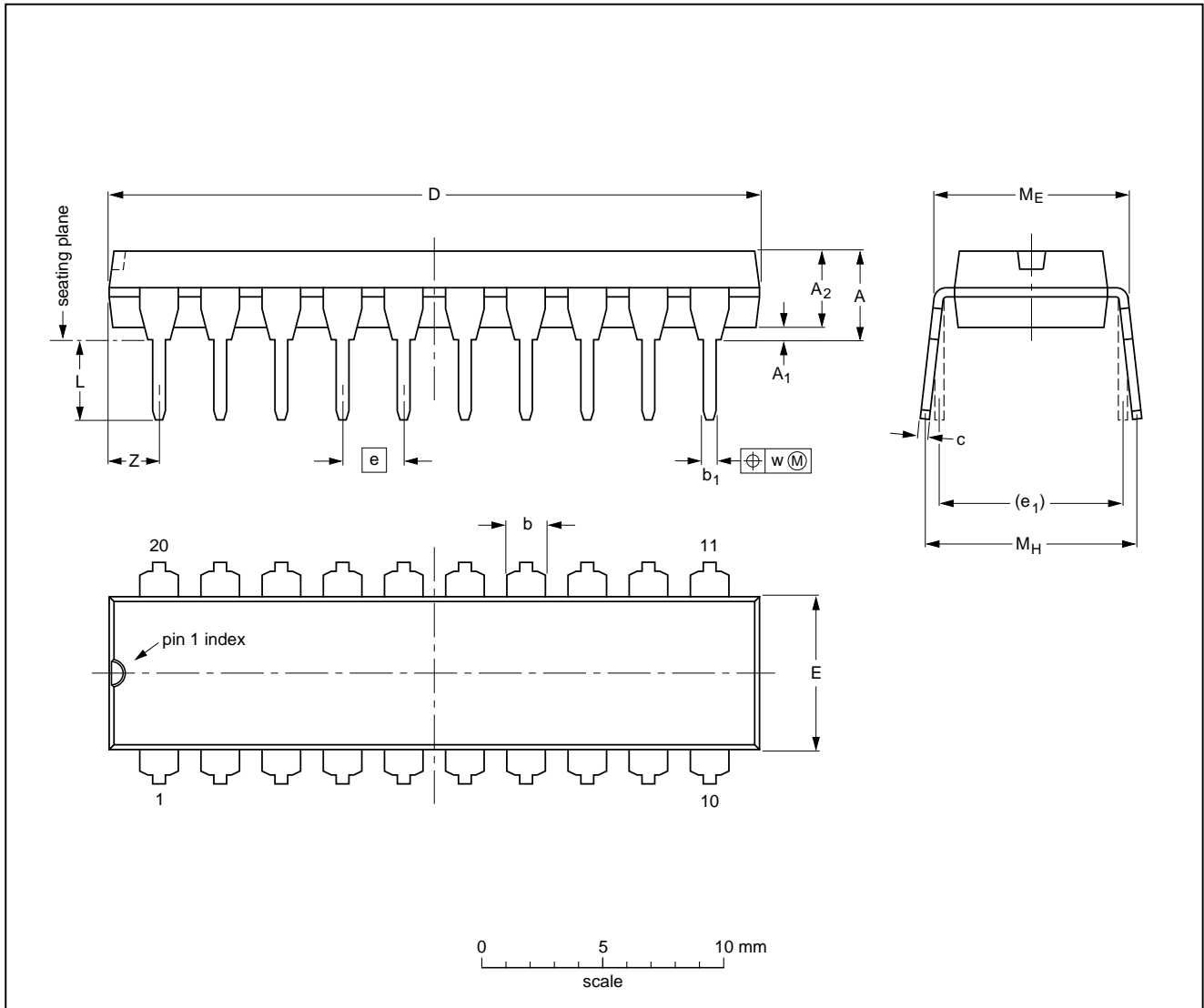

DIMENSIONS (inch dimensions are derived from the original mm dimensions)

UNIT	A max.	A ₁ min.	A ₂ max.	b	b ₁	c	D ⁽¹⁾	E ⁽¹⁾	e	e ₁	L	M _E	M _H	w	Z ⁽¹⁾ max.
mm	4.2	0.51	3.2	1.73 1.30	0.53 0.38	0.36 0.23	26.92 26.54	6.40 6.22	2.54	7.62	3.60 3.05	8.25 7.80	10.0 8.3	0.254	2.0
inches	0.17	0.020	0.13	0.068 0.051	0.021 0.015	0.014 0.009	1.060 1.045	0.25 0.24	0.10	0.30	0.14 0.12	0.32 0.31	0.39 0.33	0.01	0.078

Note

1. Plastic or metal protrusions of 0.25 mm maximum per side are not included.

OUTLINE VERSION	REFERENCES				EUROPEAN PROJECTION	ISSUE DATE
	IEC	JEDEC	EIAJ			
SOT146-1			SC603			92-11-17 95-05-24

Quasi-split sound processor with two FM demodulators

TDA3857

SOLDERING

Introduction

There is no soldering method that is ideal for all IC packages. Wave soldering is often preferred when through-hole and surface mounted components are mixed on one printed-circuit board. However, wave soldering is not always suitable for surface mounted ICs, or for printed-circuits with high population densities. In these situations reflow soldering is often used.

This text gives a very brief insight to a complex technology. A more in-depth account of soldering ICs can be found in our "IC Package Databook" (order code 9398 652 90011).

Soldering by dipping or by wave

The maximum permissible temperature of the solder is 260 °C; solder at this temperature must not be in contact

with the joint for more than 5 seconds. The total contact time of successive solder waves must not exceed 5 seconds.

The device may be mounted up to the seating plane, but the temperature of the plastic body must not exceed the specified maximum storage temperature ($T_{stg\ max}$). If the printed-circuit board has been pre-heated, forced cooling may be necessary immediately after soldering to keep the temperature within the permissible limit.

Repairing soldered joints

Apply a low voltage soldering iron (less than 24 V) to the lead(s) of the package, below the seating plane or not more than 2 mm above it. If the temperature of the soldering iron bit is less than 300 °C it may remain in contact for up to 10 seconds. If the bit temperature is between 300 and 400 °C, contact may be up to 5 seconds.

DEFINITIONS

Data sheet status	
Objective specification	This data sheet contains target or goal specifications for product development.
Preliminary specification	This data sheet contains preliminary data; supplementary data may be published later.
Product specification	This data sheet contains final product specifications.
Limiting values	
Limiting values given are in accordance with the Absolute Maximum Rating System (IEC 134). Stress above one or more of the limiting values may cause permanent damage to the device. These are stress ratings only and operation of the device at these or at any other conditions above those given in the Characteristics sections of the specification is not implied. Exposure to limiting values for extended periods may affect device reliability.	
Application information	
Where application information is given, it is advisory and does not form part of the specification.	

LIFE SUPPORT APPLICATIONS

These products are not designed for use in life support appliances, devices, or systems where malfunction of these products can reasonably be expected to result in personal injury. Philips customers using or selling these products for use in such applications do so at their own risk and agree to fully indemnify Philips for any damages resulting from such improper use or sale.