

**SWITCH-MODE POWER SUPPLY CONTROLLER**

- LOW START-UP CURRENT
- DIRECT CONTROL OF SWITCHING TRANSISTOR
- COLLECTOR CURRENT PROPORTIONAL TO BASE-CURRENT INPUT
- REVERSE-GOING LINEAR OVERLOAD CHARACTERISTIC CURVE

**DESCRIPTION**

The TDA4601 is a monolithic integrated circuit designed to regulate and control the switching transistor in a switching power supply.

Because of its wide operational range and high voltage stability even at high load changes, this IC can be used not only in TV receivers and video recorders but also in power supplies in Hi-Fi sets and active speakers.

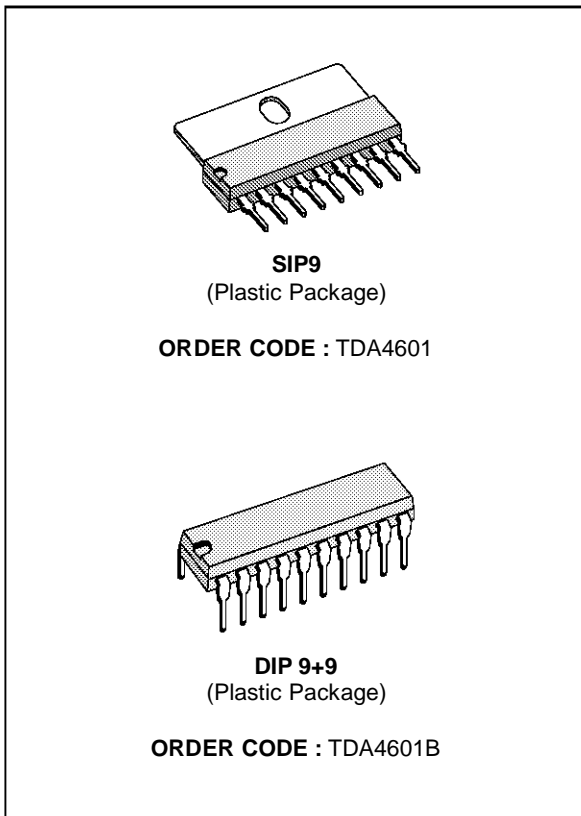

**PIN CONNECTIONS**

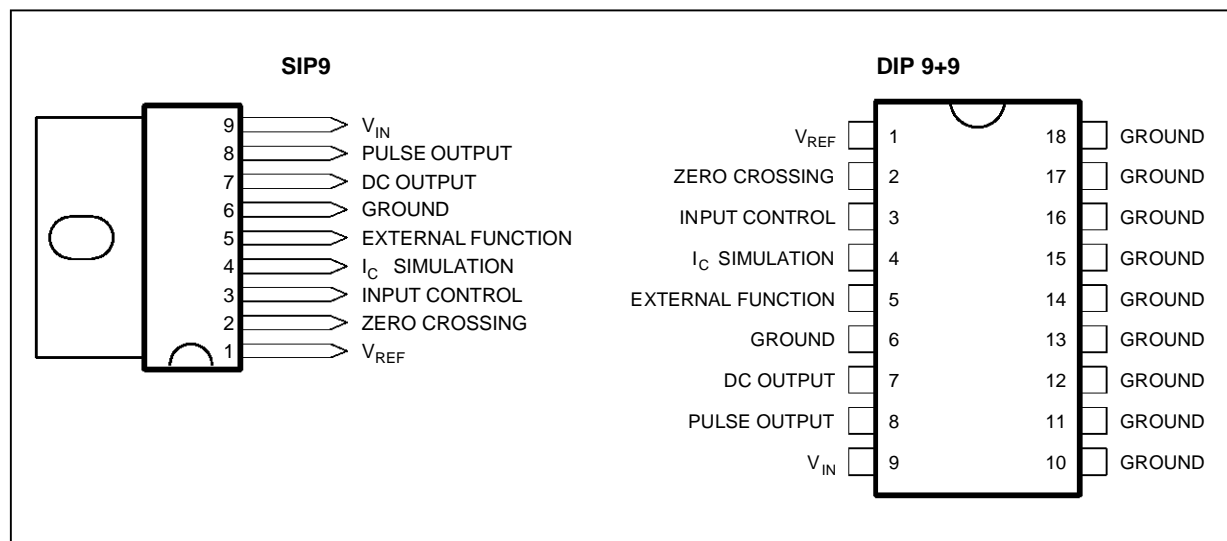

4601-01.EPS-4601-02.EPS

**BLOCK DIAGRAM**

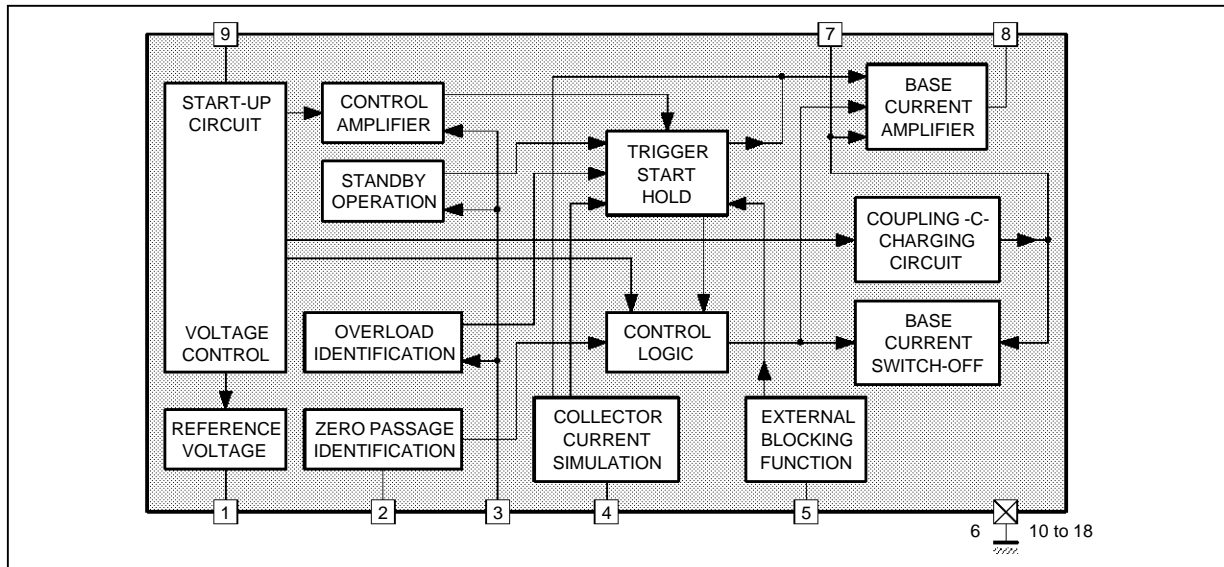

4601-03.EPS

**ABSOLUTE MAXIMUM RATINGS**

Symbol	Parameter	Value	Unit
V <sub>9</sub>	Supply Voltage	20	V
V <sub>1</sub>	Reference Output	6	V
V <sub>2</sub>	Identification Input	- 0.6, 0.6	V
V <sub>3</sub>	Controlled Amplifier	3	V
V <sub>4</sub> , V <sub>5</sub>		8	V
V <sub>7</sub> , V <sub>8</sub>		V <sub>9</sub>	
I <sub>2</sub> , I <sub>3</sub>		- 3, 3	mA
I <sub>4</sub>		5	mA
I <sub>5</sub>		5	mA
I <sub>7</sub>		1.5	A
I <sub>8</sub>		- 1.5	A
T <sub>oper</sub>	Operating Ambient Temperature	0, 85	°C
T <sub>stg</sub>	Storage Temperature	- 40, 150	°C
T <sub>j</sub>	Junction Temperature	- 40, 125	°C

4601-01.TBL

**THERMAL DATA**

Symbol	Parameter	Value	Unit
R <sub>th(j-c)</sub>	Thermal Resistance Junction-pins	Max. 15	°C/W
R <sub>th(j-a)</sub>	Thermal Resistance Junction-ambient	Max. 70	°C/W

4601-02.TBL

**ELECTRICAL CHARACTERISTICS (T<sub>amb</sub> = 25°C)**

Symbol	Parameter	Test Conditions	Min.	Typ.	Max.	Unit
V <sub>9</sub>	Operating Supply Voltage Range		7.8		18	V

START CONDITION (according to test circuit of fig. 1)

I <sub>9</sub>	Supply Current (V <sub>1</sub> not yet switched on)	V <sub>9</sub> = 2 V V <sub>9</sub> = 5 V V <sub>9</sub> = 10 V		1.5 2.4	0.5 2.0 3.2	mA mA mA
V <sub>9</sub>	Switch Threshold (V <sub>1</sub> )		11	11.8	12.3	V

4601-03.TBL

**ELECTRICAL CHARACTERISTICS** ( $T_{amb} = 25^{\circ}C$ ) (continued)

Symbol	Parameter	Test Conditions	Min.	Typ.	Max.	Unit
NORMAL OPERATION ( $V_9 = 10V$ , $V_{cont} = -10V$ , $V_{clock} = \pm 0.5V$ , $f = 20kHz$ , duty cycle 1:2 after switch on)						
$I_9$	Supply Current	$V_{cont} = -10V$ $V_{cont} = 0V$	110 50	135 75	160 100	mA mA
$V_{ref}$	Voltage Reference at Pin 1	$I_1 < 0.1mA$ $I_1 = 5mA$	4 4	4.2 4.2	4.5 4.4	V V
$V_3$	Control Voltage	$V_{cont} = 0V$	2.3	2.6	2.9	V
$V_4$	Collector Current Simulation Voltage	$V_{cont} = 0V$ , see note 1	1.8	2.2	2.5	V
$\Delta V_4$	Collector Current Simulation Voltage	$V_{cont} = 0V$ to $-10V$ , see note 1	0.3	0.4	0.5	V
$V_5$	External Protection Threshold		6	7	8	V
$V_7$	Pin 7 Output Voltage	$V_{cont} = 0V$ , see note 1	2.7	3.3	4.0	V
$V_8$	Pin 8 output Voltage	$V_{cont} = 0V$ , see note 1	2.7	3.4	4.0	V
$\Delta V_8$	Pin 8 Output Voltage Change	$V_{cont} = 0V$ to $-10V$ , see note 1	1.6	2	2.4	V
$V_2$	Feedback Voltage	see note 1		0.2		V
$T_{K1}$	Reference Voltage Temperature Coefficient			$10^{-3}$		$1/^{\circ}K$

**PROTECTION OPERATION** ( $V_9 = 10V$ ;  $V_{cont} = -10V$ ;  $V_{clock} = \pm 0.5V$ ;  $f = 20kHz$ ; duty cycle 1 : 2)

$I_9$	Supply Current	$V_5 \leq 1.8V$	14	22	28	mA
$V_7$	Switch-off Voltage	$V_5 \leq 1.8V$	1.3	1.5	1.8	V
$V_4$	Switch-off Voltage	$V_5 \leq 1.8V$	1.8	2.1	2.5	V
$V_5$	Blocking Voltage	$V_{cont} = 0V$	$\frac{V_1}{2} - 0.1$	$\frac{V_1}{2}$		V
$V_9$	Supply Voltage for $V_8$ Blocked	$V_{cont} = 0V$	6.7	7.4	7.8	V
$\Delta V_9$	Supply Voltage for $V_1$ off While Further Decreasing $V_9$		0.3	0.6	1	V

**ELECTRICAL CHARACTERISTICS** (according to test circuit of fig. 2)

$t_{on}$	Secondary Voltage Switching Time			350	450	ms
$\Delta V_2$	Voltage Variation with Load	$S_3$ Closed, $P_3 = 20W$		0.1	0.5	V
		$S_2$ Closed, $P_2 = 15W$		0.5	1	V
$\Delta V_2$	Stand by Condition	$S_1$ Open $P_{load} = 3W$		20	30	V
f	Stand by Frequency		70	75		kHz
$P_P$	Primary Power Consumption in Stand by Condition			10	12	VA

Note 1 : Only DC component

Figure 1 : Test Circuit

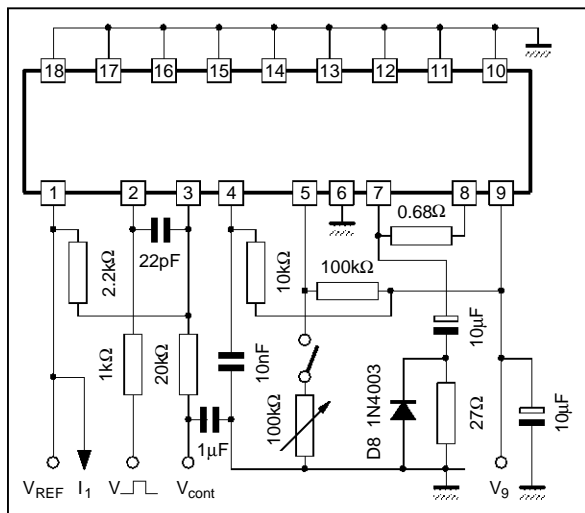

Test Diagram : Overload Operation

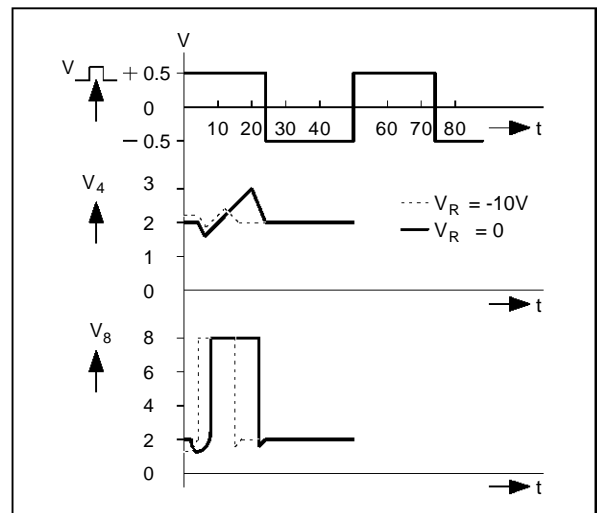

# TDA4601

**Figure 2 : Test and Application Circuit**

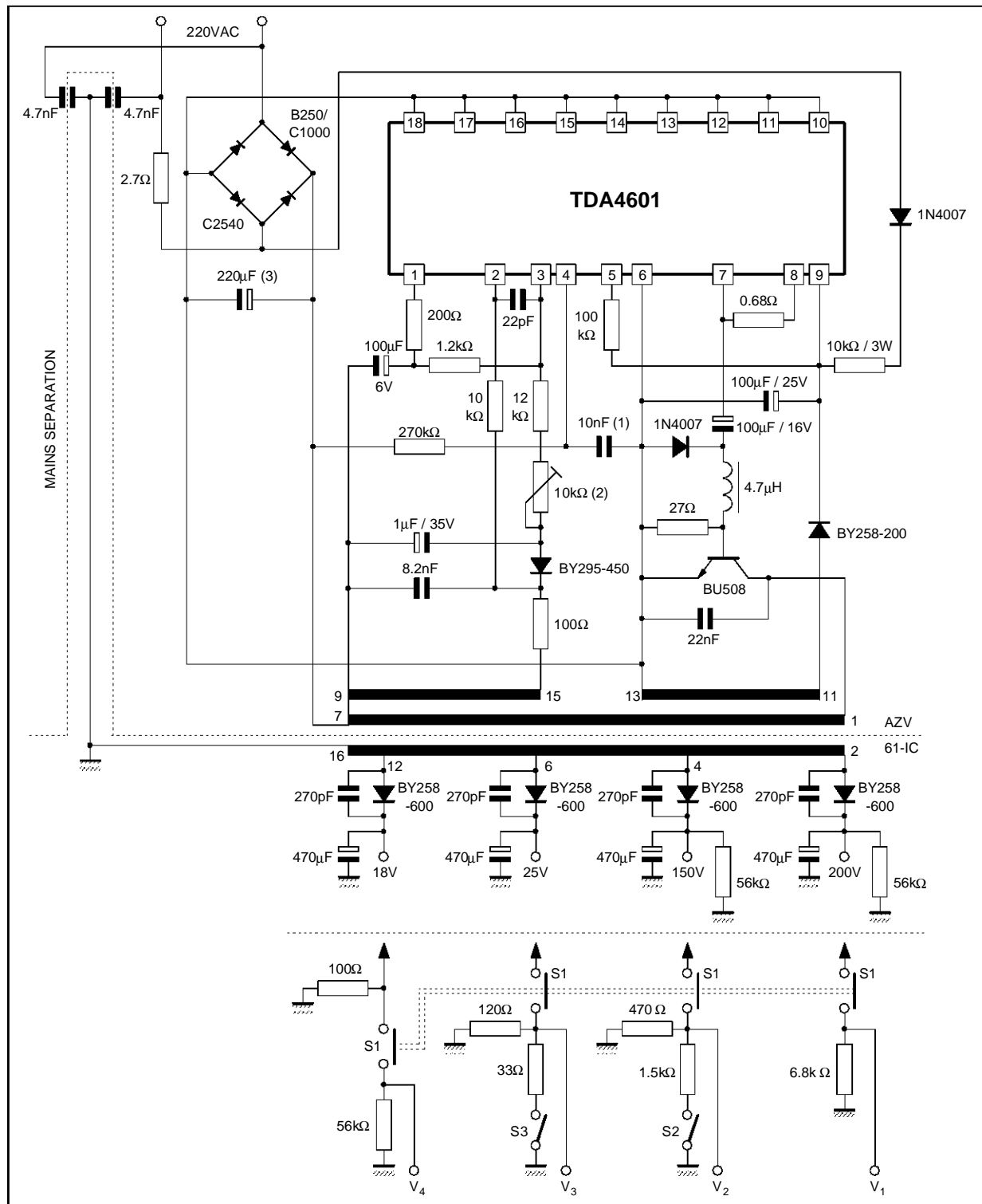

- (1) C limits the max. collector current of BU508 at overshooting the permissible output power.
- (2) Adjustment of secondary voltage.
- (3) Must be discharged before IC change.

## CIRCUIT DESCRIPTION

The TDA 4601 regulates, controls, and protects the switching transistor in reverse converter power supplies at starting, normal, and overload operation.

### Starting Behaviour

During the start-up, three consecutive operation states are passed.

1. An internal reference voltage is built up which supplies the voltage regulator and enables the supply to the coupling electrolytic capacitor and the switching transistor. Up to a supply voltage of  $V_9 \approx 12V$ , the current  $I_9$  is less than 3.2mA.
2. Release of the internal reference voltage  $V_1 = 4V$ . This voltage is abruptly available when  $V_9 \approx 12V$  and enables all parts of the IC to be supplied from the control logic with a thermally stable and overload protected current supply.
3. Release of control logic. As soon as the reference voltage is available, the control logic is switched on through an additional stabilization circuit. Thus, the IC is ready for operation.

This start-up sequence is necessary to guarantee the supply through the coupling electrolytic capacitor to the switching transistor. Correct switching of the transistor is only guaranteed in this way.

### Normal Operation

Zero crossing of the feedback coil is registered at pin 2 and passed to the control logic.

At pin 3 (regulation of input, overload, and standby recognition) the rectified amplitude variations of the feedback coil are applied. The regulating amplifier works with an input voltage of about 2V and a current of about 1.4 mA.

Together with the collector current simulation pin 4, the overload recognition defines the operating region of the regulating amplifier depending on the internal reference voltage. The simulation of the collector current is generated by an external RC network at pin 4 and internally set threshold voltages. By increasing the capacitance (10nF) the max. collector current of the switching transistor rises, thus setting the required operating range. The extent of the regulation lies between a 2V

clamped DC voltage and an AC voltage rising in a sawtooth waveform, which may vary up to a maximum amplitude of 4V (ref. voltage).

A reduction of the secondary load down to 20 watts causes the switching frequency to rise to about 50kHz at an almost constant pulse duty factor (period to on-time approx. 3). A further reduction of the secondary load down to about 1 watt results in changing the switching frequency to approx. 70kHz, and additionally the pulse duty factor rises to approx. 11. At the same time the collector peak current falls below 1A.

In the trigger the output level of the regulating amplifier, the overload recognition, and the collector current simulation are compared and instructions are given to the control logic. There is an additional triggering and blocking possibility by means of pin 5. The output at pin 8 is blocked at a voltage of less than 2.2V at pin 5.

Depending on the start-up circuit, the zero crossing identification, and the release with the aid of the trigger, the control logic flip flops are set which control the base current amplifier and the base current shut-down. The base current amplifier moves the sawtooth voltage  $V_4$  to pin 8. A current feed-back having an external resistance of  $R = 0.68\Omega$  is inserted between pin 8 and pin 7. The resistance value determines the maximum amplitude of the base driving current for the switching transistor.

### Protective Measures

The base current shut-down, released by the control logic, clamps the output of pin 7 at 1.6V and thus blocks driving of the switching transistor. This protective measure will be released if the voltage at pin 9 reaches a value  $\leq$  typ. 7.4V or if voltages of  $\leq$  typ. 2.2V occur at pin 5. In the case of a short circuit of the secondary windings of the P.S.U., the IC continuously monitors the fault condition.

With the load completely removed from the secondary winding of the P.S.U., the IC is set to a low pulse duty factor. The total power consumption of the P.S.U. is held below 6 to 10 watts in both operating conditions. After having blocked the output, caused at a supply voltage  $\leq$  typ. 7.4V, a further voltage reduction with  $\Delta V_9 = 0.6V$  results in switching off the reference voltage (4V).

**Figure 3 :** Frequency versus Output Power (Test Circuit of Figure 2)

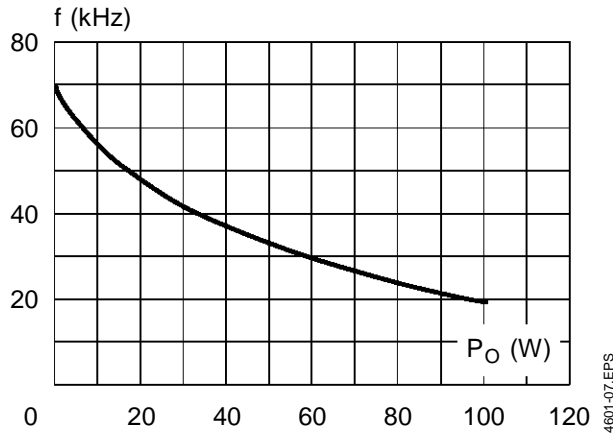

**Figure 4 :** Efficiency versus Output Power (Test Circuit of Figure 2)

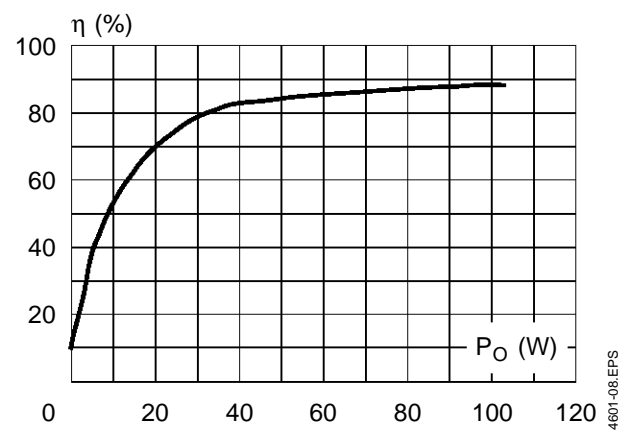

**Figure 5 :** Load Characteristics  $V_2$ - $f(I_{O2})$  (Test Circuit of Figure 2)

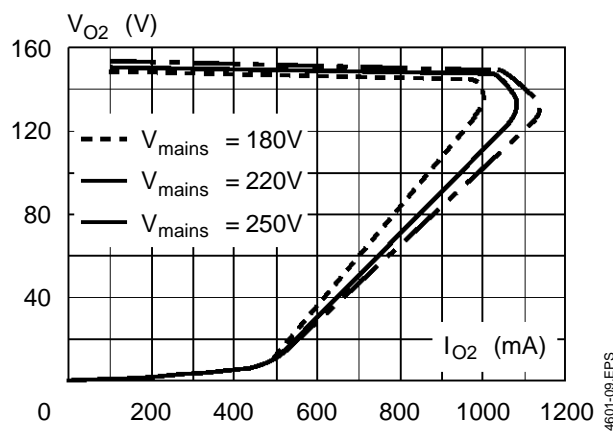

**Figure 6 :** Output Voltage  $V_2$  (mains change) (Test Circuit of Figure 2)

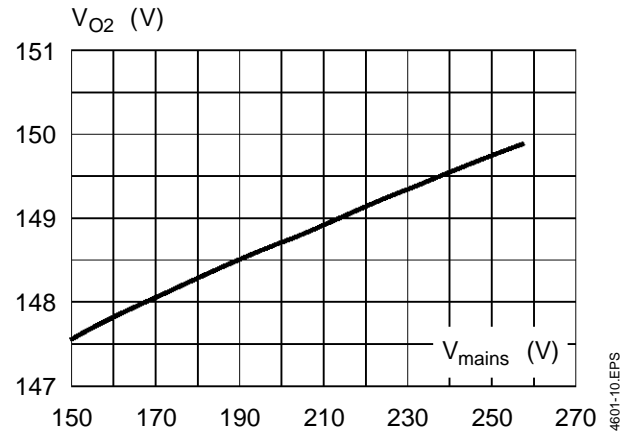

**Figure 7 :** Example of a PC Heatsink (35°C/W)

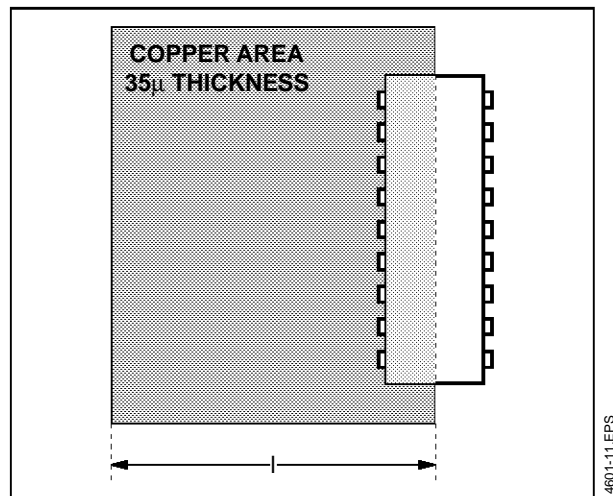

**PACKAGE MECHANICAL DATA**  
**9 PINS - PLASTIC SIP**

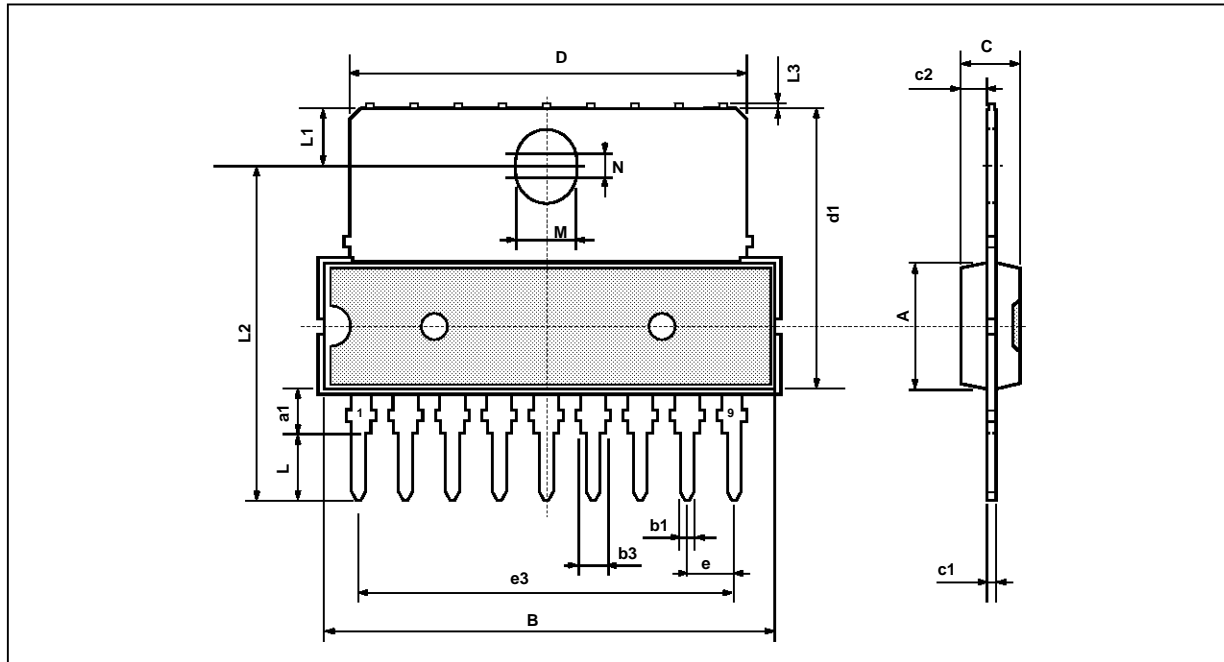

PM-SIP9.EPS

Dimensions	Millimeters			Inches		
	Min.	Typ.	Max.	Min.	Typ.	Max.
A			7.1			0.280
a1	2.7		3	0.106		0.118
B			24.8			0.976
b1		0.5			0.020	
b3	0.85		1.6	0.033		0.063
C		3.3			0.130	
c1		0.43			0.017	
c2		1.32			0.052	
D			21.2			0.835
d1		14.5			0.571	
e		2.54			0.100	
e3		20.32			0.800	
L	3.1			0.122		
L1		3			0.118	
L2		17.6			0.693	
L3			0.25			0.010
M		3.2			0.126	
N		1			0.039	

SIP9.TBL

# TDA4601

## PACKAGE MECHANICAL DATA 18 PINS - PLASTIC POWERDIP

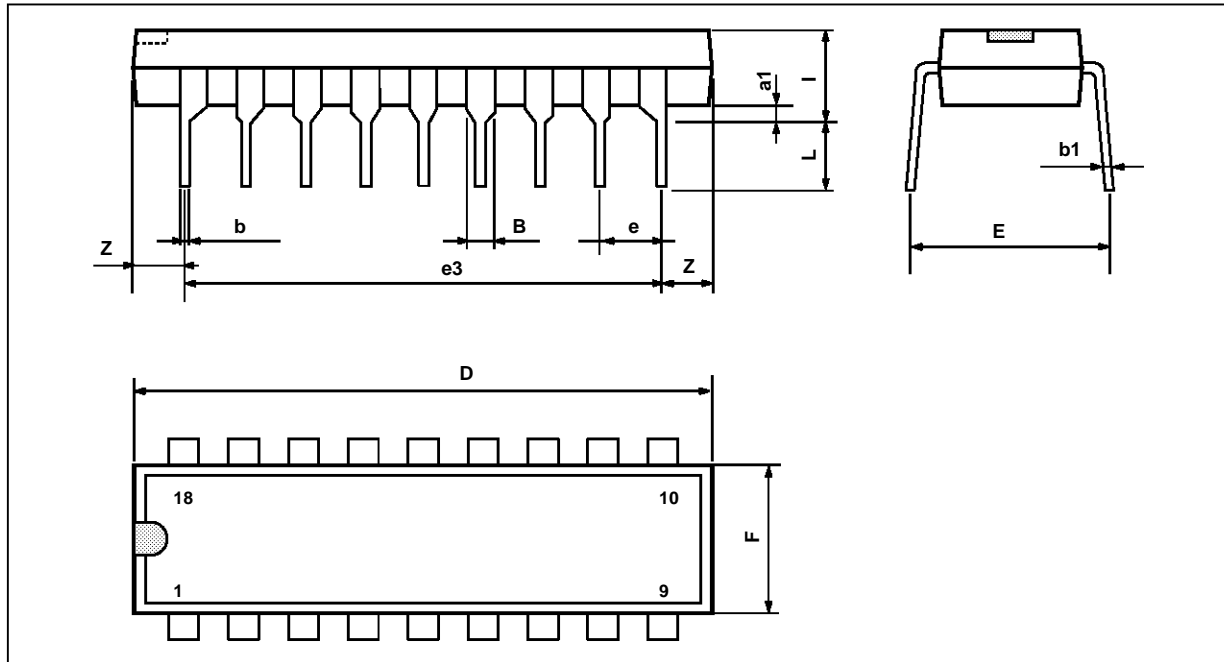

PMDIP18W.EPS

Dimensions	Millimeters			Inches		
	Min.	Typ.	Max.	Min.	Typ.	Max.
a1	0.51			0.020		
B	0.85		1.4	0.033		0.055
b		0.5			0.020	
b1	0.38		0.5	0.015		0.020
D			24.8			0.976
E		8.8			0.346	
e		2.54			0.100	
e3		20.32			0.800	
F			7.1			0.280
i			5.1			0.201
L		3.3			0.130	
Z			2.54			0.100

DIP18PW.TBL

Information furnished is believed to be accurate and reliable. However, SGS-THOMSON Microelectronics assumes no responsibility for the consequences of use of such information nor for any infringement of patents or other rights of third parties which may result from its use. No licence is granted by implication or otherwise under any patent or patent rights of SGS-THOMSON Microelectronics. Specifications mentioned in this publication are subject to change without notice. This publication supersedes and replaces all information previously supplied. SGS-THOMSON Microelectronics products are not authorized for use as critical components in life support devices or systems without express written approval of SGS-THOMSON Microelectronics.

© 1994 SGS-THOMSON Microelectronics - All Rights Reserved

Purchase of I<sup>2</sup>C Components of SGS-THOMSON Microelectronics, conveys a license under the Philips I<sup>2</sup>C Patent. Rights to use these components in a I<sup>2</sup>C system, is granted provided that the system conforms to the I<sup>2</sup>C Standard Specifications as defined by Philips.

SGS-THOMSON Microelectronics GROUP OF COMPANIES

Australia - Brazil - China - France - Germany - Hong Kong - Italy - Japan - Korea - Malaysia - Malta - Morocco  
The Netherlands - Singapore - Spain - Sweden - Switzerland - Taiwan - Thailand - United Kingdom - U.S.A.