

Mute detector IC

BA336/BA338/BA338L

The BA336, BA338 and BA338L are monolithic ICs designed for mute detection and tape end detection. When a duration of silence (52dBm or less) exceeds the time constant set with an external CR circuit, a song gap is identified, and after this a plunger control signal is output during a pulse whose width is determined by another external CR circuit. These functions are contained in a compact 9-pin package.

The circuit configuration consists of a pre-amp with limiter, a comparator flip-flop, and a driver. Circuitry is also included which prevents errors when the power is turned on, and measures have been taken to prevent errors due to excessive input, song gap noise, and other factors.

●Applications

- Mute detection
- Tape end detection

●Features

- 1) Mute detection time and output pulse width can be set within a broad range by an external CR circuit.
- 2) Includes circuit for preventing errors due to song gap noise.
- 3) Includes over-current protection circuit.
- 4) Includes circuit for preventing errors when the power is turned on.
- 5) Detection can be stopped using an external input.

●Block diagram

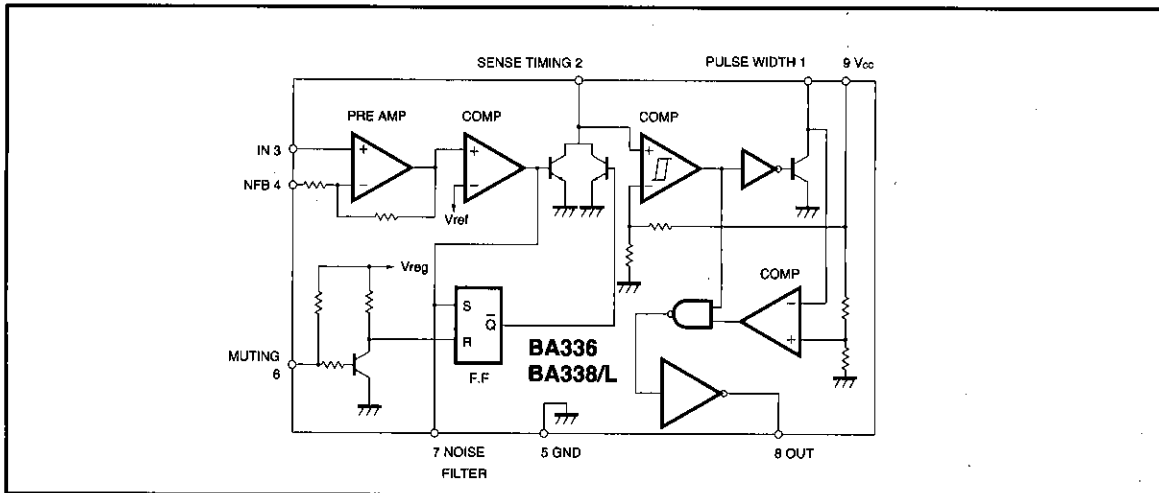

● Absolute maximum ratings (Ta = 25°C)

Parameter	Symbol	Limits	Unit
Supply voltage	V _{CC}	16	V
Power dissipation	BA336/BA338	Pd	mW
	BA338L		
Operating temperature	T _{opr}	-20~75	°C
Storage temperature	T _{stg}	-50~125	°C
Over-current protection time	T _{STOL}	0.1*2	s

*1 Reduced by 5.4mW for each increase in Ta of 1°C over 25°C.

*2 V_{CC}=16V, R_L=20Ω

● Over-current protection time (Ta = 25°C)

Parameter	Symbol	Min.	Typ.	Max.	Unit
Supply voltage	V _{CC}	4.2	—	12	V

● Electrical characteristics (unless otherwise indicated, Ta = 25°C and V_{CC} = 9.0V)

Parameter	Symbol	Min.	Typ.	Max.	Unit	Conditions	Measuremet Circuit	
Quiescent current	I _Q	—	6.5	11	mA	—	Fig.5	
Input threshold level	V _{IN}	-55	-52	-49	dBm	f=10kHz, Cf=1μF	Fig.5	
Input current	I _{IN}	—	0.2	2.0	μA	—	Fig.5	
Mute detection time accuracy	BA336	T _{ERR (D)}	—	3	10	%	R _D =500kΩ, C _D =0.1μF	Fig.5
	BA338/L							
Output pulse width accuracy	BA336	T _{ERR (W)}	—	3	10	%	R _D =500kΩ, C _D =0.01μF	Fig.5
	BA338/L							
Low level output voltage	V _{OL}	—	0.3	0.5	V	I _{SINK} =3.5mA	Fig.5	
High level output voltage	V _{OH}	6.0	7.0	—	V	I _{PRURCE} =80mA	Fig.5	

● Electrical characteristics (unless otherwise indicated, Ta = 25°C and V_{CC} = 9.0V)

Parameter	Symbol	Min.	Typ.	Max.	Unit	Conditions	Measuremet Circuit	
Output limit current	BA336	80	150	—	mA	—	Fig.5	
	BA338/L	—						
Pin 6 threshold voltage	V _{6TH}	0.7	1.2	1.8	V	*	Fig.5	
Pin 6 output current	BA336	30	70	115	μA	V _{P6} (6pin Voltage)=0V	Fig.5	
	BA338/L	—		—				
Pin 7 threshold voltage	BA336 BA338/L	V _{7TH}	0.5	0.65	0.8	V	Measure with pin 2 at 4.5V	Fig.5
Pin 7 output current	BA338/L	I _{NO}	—	200	—	μA	V _{P7} (7pin Voltage)=0V, 3pin Voltage=1V	Fig.5

* When the mute pin (Pin 6) is below 0.7 V, the detection function is disabled and an output pulse is not generated.
When above 1.8 V the detection function is on standby.

● Electrical characteristic curves

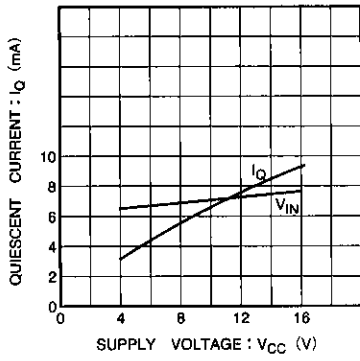

Fig. 1 Quiescent current vs. supply voltage

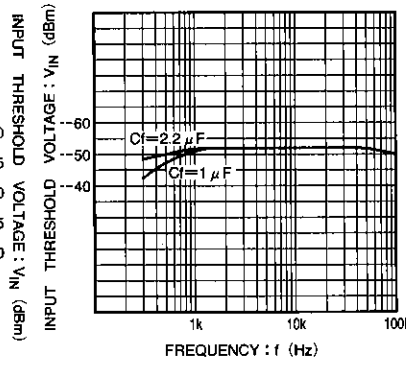

Fig. 2 Input threshold voltage vs. frequency

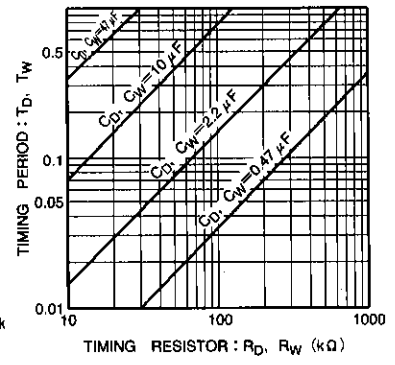

Fig. 3 Relation of external capacitors and resistors to mute detection time T_D and output pulse width T_w

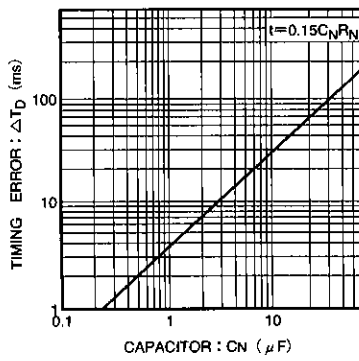

Fig. 4 Relation of C_N and R_N to increase of T_D

● Measurement circuit

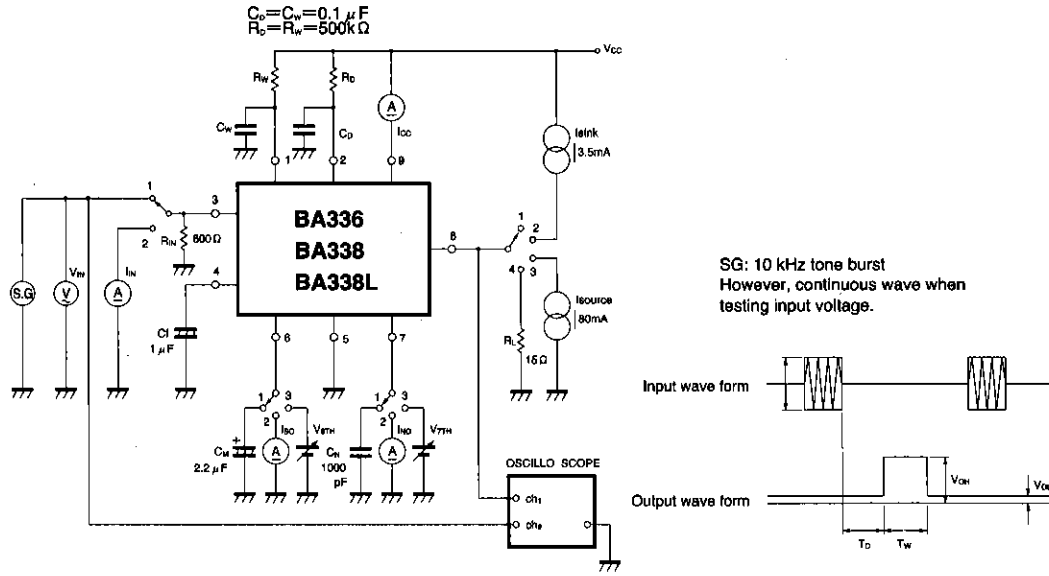

Fig. 5

Mute detectors

Audio accessory components

● Explanation of operation

The BA336/BA338/BA338L operates according to the timing shown in Fig. 6. When the input signal is below the input decision level, the electrical potential of Pin 2 begins to rise according to the time constant set by C_D and R_D . When it reaches $1/2$ of V_{CC} , the comparator which sets the mute detection time inverts. At this point the potential of Pin 1 begins to rise according to the time constant set by C_W and R_W , and when it reaches $1/2$ of V_{CC} , the pulse width comparator inverts. During the interval from the inverting of the mute detection time comparator to the inverting of the pulse width

comparator, the output is high. When the power is turned on or muting is turned off, a reset pulse is generated for a certain period of time (determined by the Pin 6 capacitor), the internal flip-flop resets, and an output pulse is not generated. When an input signal comes in after this, the flip-flop resets, mute detection goes on standby, and an output pulse is obtained with each song gap. If the mute time is T_M , the song detection time T_D and the output pulse width T_W must be selected so that $T_D + T_W < T_M$. Furthermore, T_D must be made longer than any periods of silence in songs.

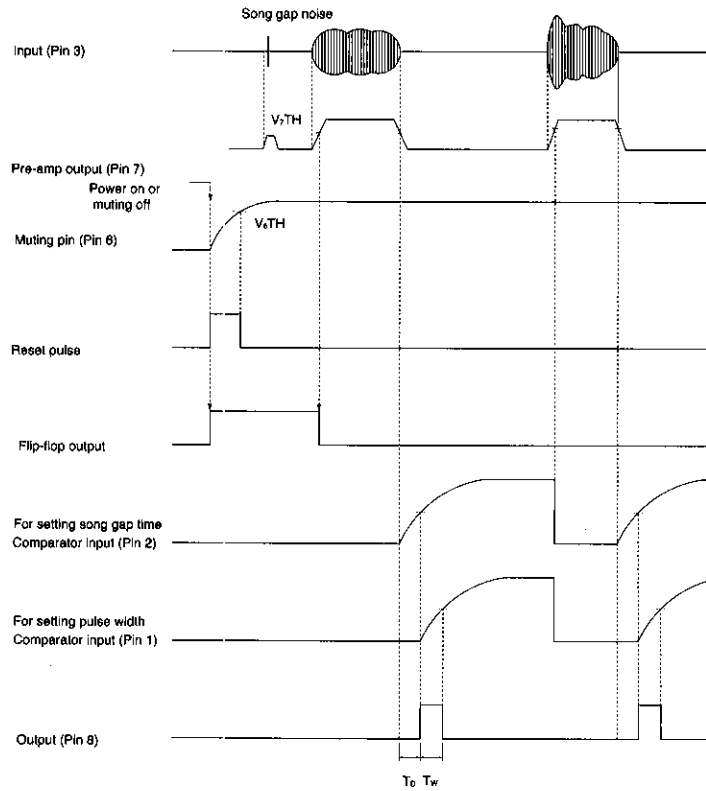

Fig. 6 Timing chart

●Application example

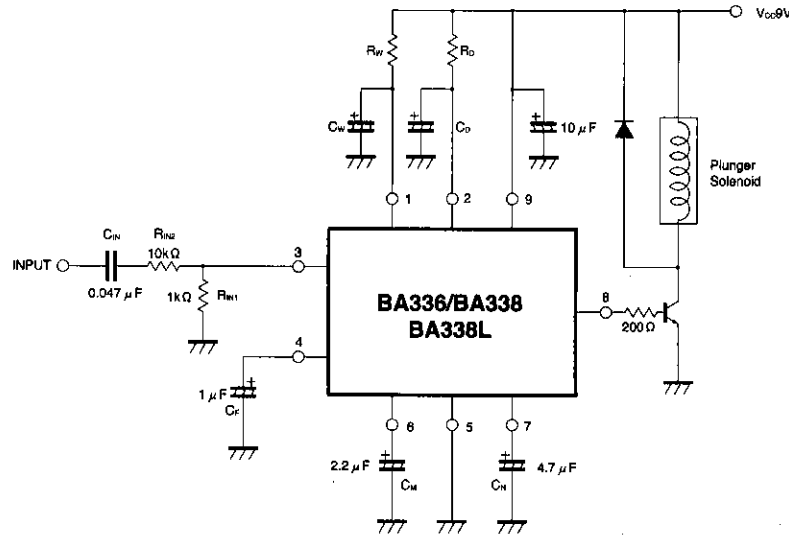

Fig. 7

●Explanation of external components (see Fig. 7)

(1) Input coupling capacitor C_{IN} and resistor R_{IN} (Pin 3)
 This capacitor is for coupling a pre-amp to the BA336/BA338/BA338L.
 If the DC level of the pre-amp output is GND, the coupling capacitor can be omitted. If a coupling capacitor is connected, Pin 3 must be connected to GND through a resistor. If the resistor between Pin 3 and GND is too large, an offset will occur due to a voltage drop caused by the input current, and the input decision level will change. We recommend 10kΩ or less. The input decision level of the BA336/BA338/BA338L is highly sensitive at -52dBm. In the application example, the pre-stage output is divided to adjust the sensitivity and increase the input impedance. Furthermore, the low cutoff frequency f_c is determined by the input circuit time constant or the Pin 4 time constant, whichever is smaller. As it is better to determine f_c by the Pin 4 C_F when the power is turned on, we recommend making the time constant of the input circuit larger than that of Pin 4.

(2) DC cutoff capacitor in feedback circuit C_F (Pin 4)
 This determines the low cutoff frequency f_c . The relation of C_F and f_c is as follows :

$$C_F = \frac{1}{0.4 \pi f_c \text{ (kHz)}} \text{ (}\mu\text{F)}$$

If $C_F = 1 \mu\text{F}$, $f_c \cong 800\text{Hz}$.

The larger C_F is, the more time it will take for the circuit to stabilize when the power is turned on.

(3) Muting capacitor for power up C_M (Pin 6)
 After the power is turned on, this capacitor stops song selection until the circuit stabilizes. If the value of C_F is large, a large C_M will also be necessary. C_M must be greater than C_F . Also, if it takes longer for the external circuit to stabilize, select C_M based on the external circuit. The relation between C_M and the muting time is as follows :

$$T_M \cong 30C_M \text{ (}\mu\text{F)}$$

(4) Noise filter capacitor C_N (Pin 7)
 This capacitor prevents errors due to pulse noise. When an input signal is shorter than the time determined by $T_N = C_N \text{ (}\mu\text{F)}$ ms (BA338/BA338L) or $T_N = 20C_N \text{ (}\mu\text{F)}$ ms (BA336), the IC will not respond and an output pulse will not be generated. If pulse noise appears continuously at the input, the effectiveness of the noise filter will be decreased. If it is likely that continuous noise will appear, attach a discharge resistor R_N between Pin 7 and GND ($R_N \geq 30k\Omega$).

There are differences in the noise filter functions of the BA336 and the BA338/BA338L. Refer to the section, "Differences between the noise filters of the BA336 and BA338/BA338L".

Mute detectors
 Audio accessory components

(5) Capacitor C_w and resistor R_w (Pin 1) for setting output pulse width

The relation between C_w , R_w and the output pulse width T_w is as follows :

$$T_w \approx 0.69 \times C_w (\mu F) \times R_w (k\Omega) \text{ ms}$$

T_w is almost independent of the supply voltage.

If R_w is small (less than 10k Ω), errors increase. See Fig. 3.

(6) Capacitor C_D and resistor R_D (Pin 2) for setting song gap detection time

The relation between C_D , R_D and the detection time T_D (the duration from the point when the input signal goes below the input decision level to the generation of the output pulse) is as follows :

BA336 :

$$T_D = 0.69 \times C_D (\mu F) \times R_D (k\Omega)$$

BA338/BA338L :

$$T_D = 0.69 \times C_D (\mu F) \times R_D (k\Omega) + 0.15 \times C_N (\mu F) \times R_N (k\Omega)$$

(The internal resistor R_N is 25 to 100k Ω .)

T_D is almost independent of the supply voltage.

If R_D is small (less than 10k Ω), errors increase. See Fig. 3.

● Operation notes

(1) The input decision level of the BA336/BA338/BA338L is a highly sensitive -52dBm. This can cause the output current to return to the input through the common impedance of the ground line. Be sure to decouple the power supply line and prevent common impedance with the ground line. Adding a 0.1 μF capacitor between Pin 8 and GND is effective, and we strongly recommend doing so when high current is used.

(2) The maximum output current of the BA336/BA338/BA338L can be up to 150mA (typical). However, if left in the current limited state for a long time when using a high voltage power supply, damage to the IC can result. Be sure not to exceed the rated power dissipation and the over-current protection time.

(3) When the BA336/BA338/BA338L is input into a counter IC, make sure the input is above the 2V_F threshold (approximately 1.3V). Otherwise, there is a possibility that a miscount will occur due to the output pulse generated (approximately 0.5V, see Fig. 8) when the power is turned on or off.

If a C_N is added in the case of the BA338/BA338L, its discharge time will cause T_D to be slightly longer than it is when $C_N = 0$.

Caution is required if T_D is made short or a large C_N is used. (See Fig. 4)

Counting may be mistaken due to the output pulse (approx 0.5V, Fig. 8) when the power supply is turned ON or OFF.

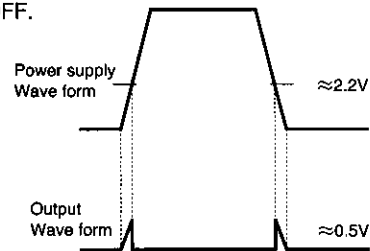
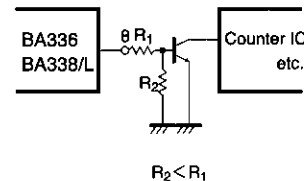

Fig. 8



The threshold is increased by adding R_2 .

Fig. 9 Circuit example

● Differences between the noise filters of the BA336 and BA338/BA338L

The basic configurations of the BA336 and BA338/BA338L are the same, however, the noise filters are different.

BA336 The noise filter only operates from the time the power is turned on or muting is turned off to the arrival of the input signal. The power must be turned off or muting turned on each time an output signal is generated.

BA338/BA338L The noise filter operates continuously while the power is on. However, as noted previously the song gap detection time can change slightly due to the capacitor C_N connected to the noise filter pin.

● External dimensions (Unit: mm)

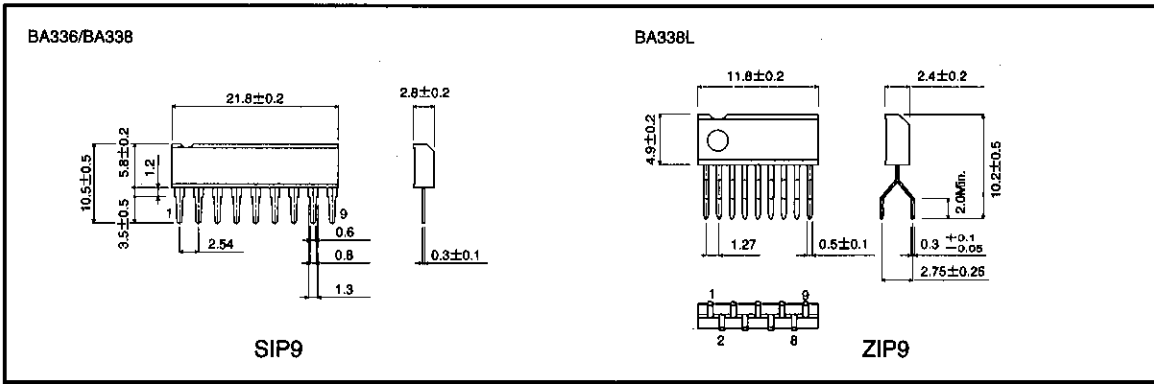

Mute detectors

Audio accessory components