

**60 W HI-FI DUAL AUDIO DRIVER**

- WIDE SUPPLY VOLTAGE RANGE : 20 TO 90 V ( $\pm 10$  to  $\pm 45$  V)
- VERY LOW DISTORTION
- AUTOMATIC QUIESCENT CURRENT CONTROL FOR THE POWER TRANSISTORS WITHOUT TEMPERATURE SENSE ELEMENTS
- OVERLOAD CURRENT PROTECTION FOR THE POWER TRANSISTORS
- MUTE/STAND-BY FUNCTIONS
- LOW POWER CONSUMPTION
- OUTPUT POWER 60 W/8  $\Omega$  AND 100 W/4  $\Omega$

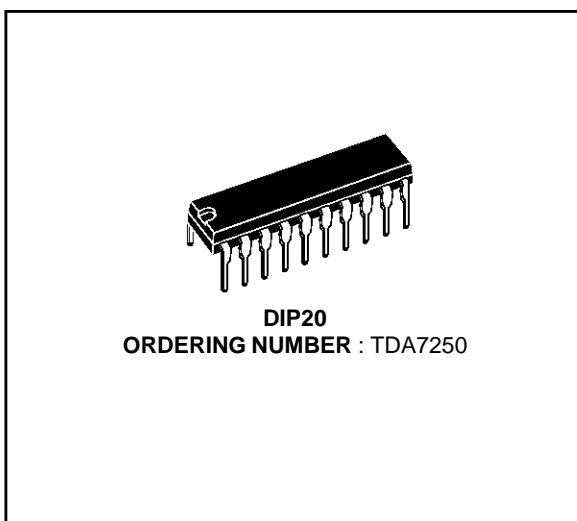

**DESCRIPTION**

The TDA7250 stereo audio driver is designed to drive two pair of complementary output transistor in the Hi-Fi power amplifiers.

**APPLICATION CIRCUIT**

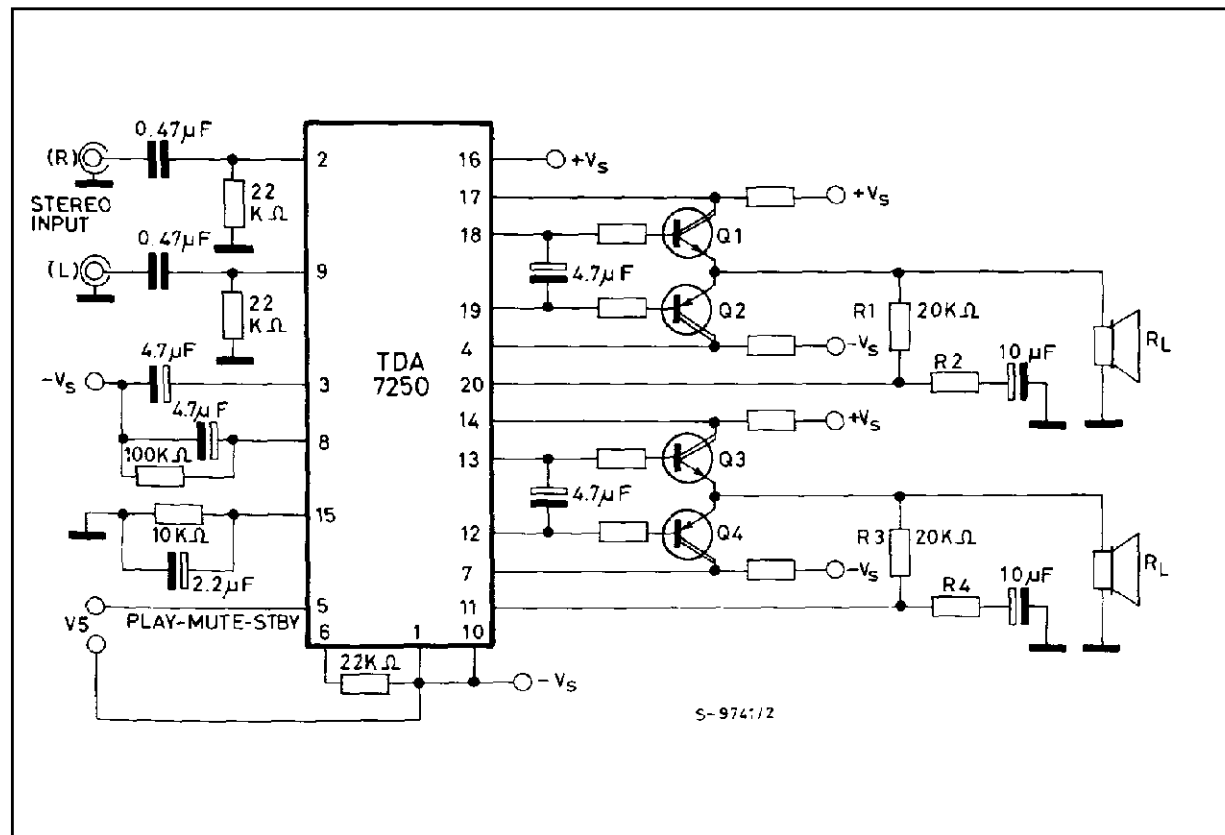

## TDA7250

### PIN CONNECTION (top view)

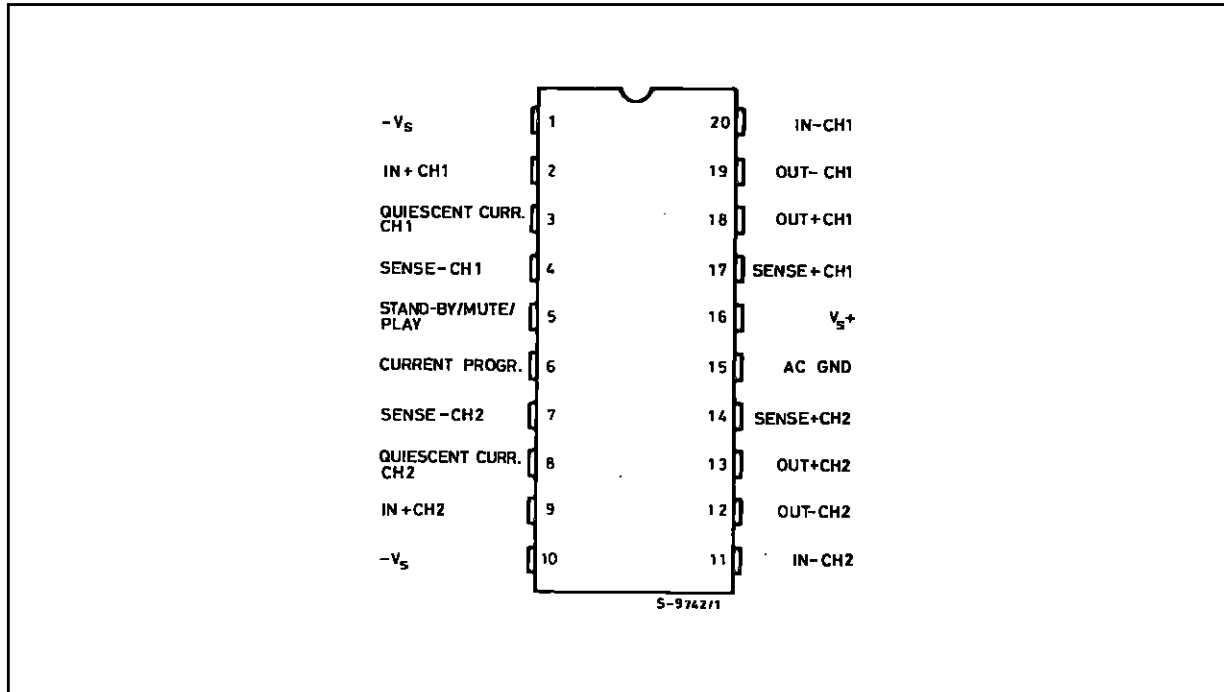

### ABSOLUTE MAXIMUM RATINGS

Symbol	Parameter	Value	Unit
$V_s$	Supply Voltage	100	V
$P_{tot}$	Power Dissipation at $T_{amb} = 60\text{ °C}$	1.4	W
$T_j, T_{stg}$	Storage and Junction Temperature	- 40 to + 150	°C

### THERMAL DATA

Symbol	Parameter	Value	Unit
$R_{th\ j-amb}$	Thermal Resistance Junction-ambient	Max. 65	°C/W

## PIN FUNCTIONS

N°	Name	Function
1	V <sub>S</sub> – POWER SUPPLY	Negative Supply Voltage.
2	NON-INV. INP. CH. 1	Channel 1 Input Signal.
3	QUIESC. CURRENT CONTR. CAP. CH1	This capacitor works as an integrator, to control the quiescent current to output devices in no-signal conditions on channel 1.
4	SENSE (-) CH. 1	Negative voltage sense input for overload protection and for automatic quiescent current control.
5	ST. BY / MUTE / PLAY	Three-functions Terminal. For V <sub>IN</sub> = 1 to 3 V, the device is in MUTE and only quiescent current flows in the power stages ; - for V <sub>IN</sub> < 1 V, the device is in STAND-BY mode and no quiescent current is present in the power stages ; - for V <sub>IN</sub> > 3 V, the device
6	CURRENT PROGRAM	High Impedance Power-stages Monitor.
7	SENSE (-) CH. 2	Negative Voltage Sense Input for Overload Protection and for Automatic Quiescent Current Control.
8	QUIESC. CURRENT CONTR. CAP. CH. 2	This capacitor works as an integrator, to control the quiescent current to output devices in no-signal conditions on channel 2. If the voltage at its terminals drops under 250 mV, it also resets the device from high-impedance state of output stages.
9	NON-INV. INP. CH. 2	Channel 2 Input Signals.
10	V <sub>S</sub> – POWER SUPPLY	Negative Supply Voltage.
11	INVERT. INP. CH. 2	Feedback from Output (channel 2).
12	OUT (-) CH. 2	Out Signal to Lower Driver Transistor of Channel 2.
13	OUT (+) CH. 2	Out Signal to Higher Driver Transistor of Channel 2.
14	SENSE (+) CH. 2	Positive Voltage Sense Input for Overload Protection and for Automatic Quiescent Current Control.
15	COMMON AC GROUND	AC Input Ground in MUTE Condition.
16	V <sub>S</sub> + POWER SUPPLY	Positive Supply Voltage.
17	SENSE (+) CH. 1	Positive Voltage Sense Input for Overload Protection and for Automatic Quiescent Current Control.
18	OUT (+) CH. 1	Out Signal to High Driver Transistor of Channel 1.
19	OUT (-) CH. 1	Out Signal to Low Driver Transistor of Channel 1.
20	INVERT. INP. CH. 1	Feedback from Output (channel 1).

BLOCK DIAGRAM

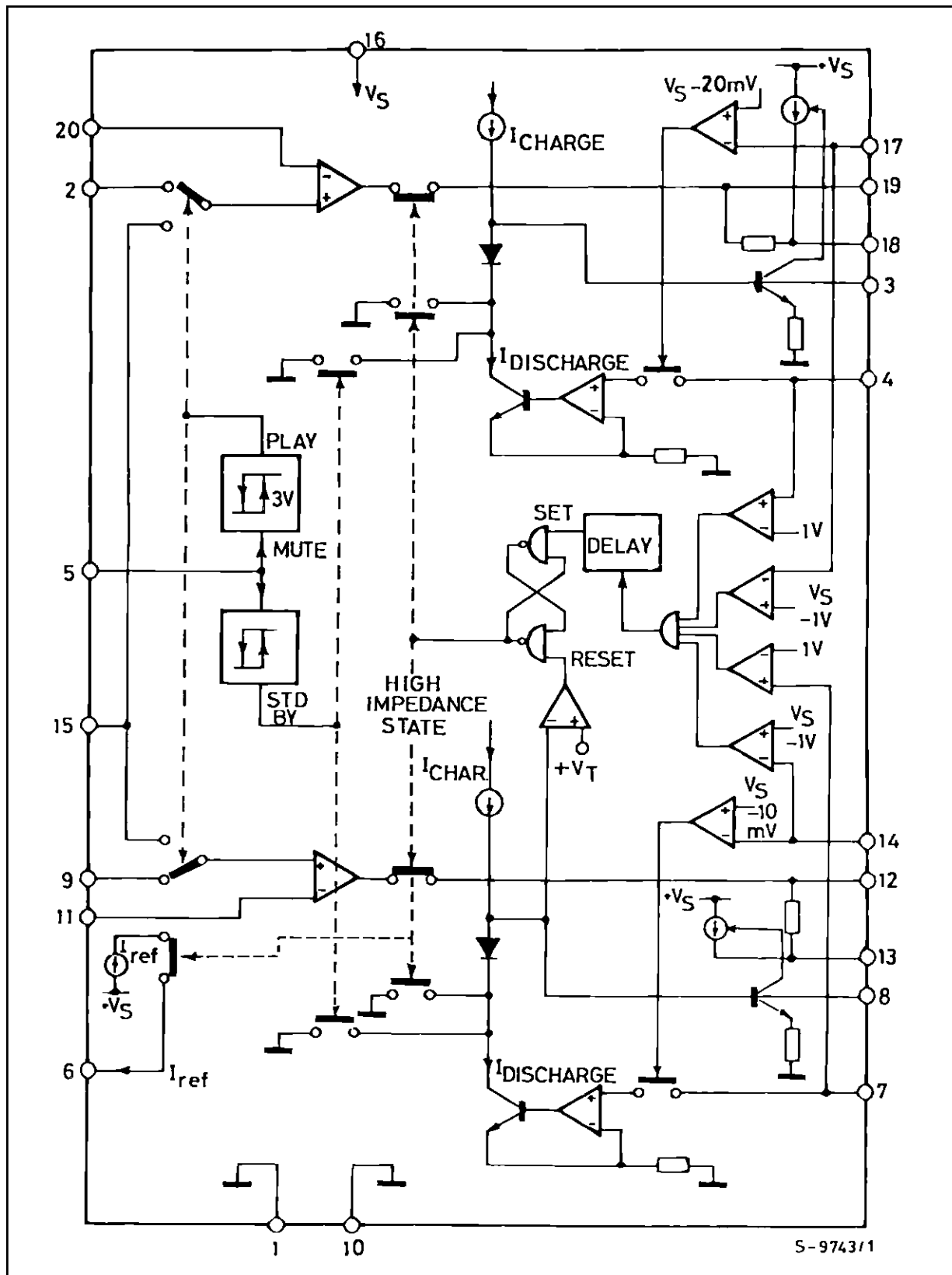

**ELECTRICAL CHARACTERISTICS** ( $T_{amb} = 25\text{ }^{\circ}\text{C}$ ,  $V_s = \pm 35\text{ V}$ , play mode, unless otherwise specified)

Symbol	Parameter	Test Conditions	Min.	Typ.	Max.	Unit
$V_s$	Supply Voltage		$\pm 10$		$\pm 45$	V
$I_d$	Quiescent Drain Current	Stand-by Mode		8		mA
		Play Mode		10	14	
$I_b$	Input Bias Current			0.2	1	$\mu\text{A}$
$V_{os}$	Input Offset Voltage			1	$\pm 10$	mV
$I_{os}$	Input Offset Current			100	200	nA
$G_v$	Open Loop Voltage Gain	$f = 100\text{ Hz}$		90		dB
		$f = 10\text{ kHz}$		60		
$e_N$	Input Noise Voltage	$R_G = 600\ \Omega$ $B = 20\text{ Hz to } 20\text{ kHz}$		3		$\mu\text{V}$
SR	Slew Rate			10		V/ $\mu\text{s}$
d	Total Harmonic Distortion	$G_v = 26\text{ dB}$ , $P_o = 40\text{ W}$ $f = 1\text{ kHz}$ $f = 20\text{ kHz}$		0.004 0.03		% %
$V_{opp}$	Output Voltage Swing			60		$V_{pp}$
$P_o$	Output Power (*)	$V_s = \pm 35\text{ V}$ , $R_L = 8\ \Omega$ $V_s = \pm 30\text{ V}$ , $R_L = 8\ \Omega$ $V_s = \pm 35\text{ V}$ , $R_L = 4\ \Omega$		60 40 100		W W W
$I_o$	Output Current			$\pm 5$		mA
SVR	Supply Voltage Rejection	$f = 100\text{ Hz}$		75		dB
$C_s$	Channel Separation	$f = 1\text{ kHz}$		75		dB

### MUTE / STANDBY/ PLAY FUNCTIONS

Symbol	Parameter	Test Conditions	Min.	Typ.	Max.	Unit
$I_i$	Input Current (pin 5)			0.1		$\mu\text{A}$
$V_{th}$	Comparator Standby / Mute Threshold (**)		1.0	1.25	1.5	V
H	Hysteresis Standby / Mute			200		mV
$V_{th}$	Comparator Mute / Play Threshold (**)		2.4	3.0	3.6	V
H	Hysteresis Mute / Play			300		mV
	Mute Attenuation	$f = 1\text{ kHz}$		60		dB
$V_i$	Input Voltage Max. (pin 5)		12 (**)			V

(\*) Application circuit of fig. 1  $f = 1\text{ KHz}$ ;  $d = 0.1\%$ ;  $G_v = 26\text{ dB}$ .

(\*\*) Referred to  $-V_s$ .

### CURRENT SURVEY CIRCUITRY

Symbol	Parameter	Test Conditions	Min.	Typ.	Max.	Unit
	Comparator Reference	to $+V_s$ to $-V_s$	0.8 0.8	1 1	1.4 1.4	V V
$t_d$	Delay Time		10			$\mu\text{s}$

### QUIESCENT CURRENT CONTROL

Symbol	Parameter	Test Conditions	Min.	Typ.	Max.	Unit
	Capacitor Current	Charge Discharge	30 250	60 500		$\mu\text{A}$ $\mu\text{A}$
	Comparator Reference	to $+V_s$ to $-V_s$	10 10	20 10	25	mV mV



Figure 2 : Output Power vs. Supply Voltage.

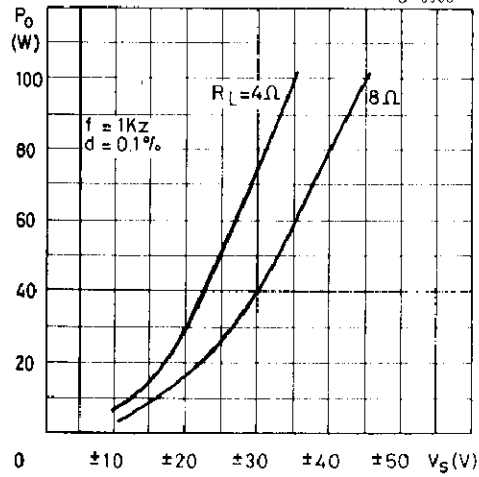

Figure 4 : Channel Separation.

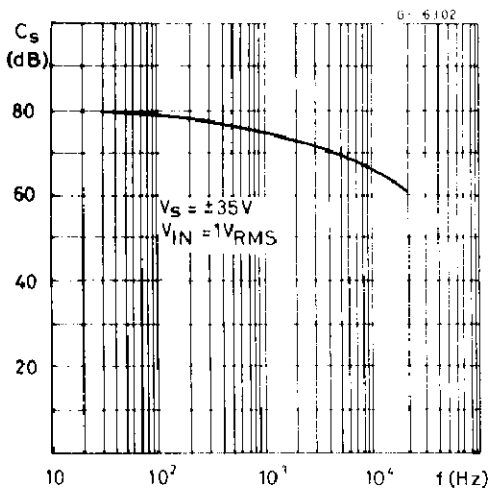

Figure 6 : Quiescent Current vs. Supply Voltage.

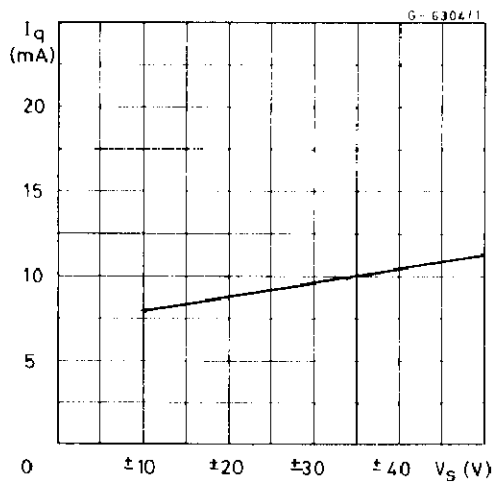

Figure 3 : Distortion vs. Output Power (\*).

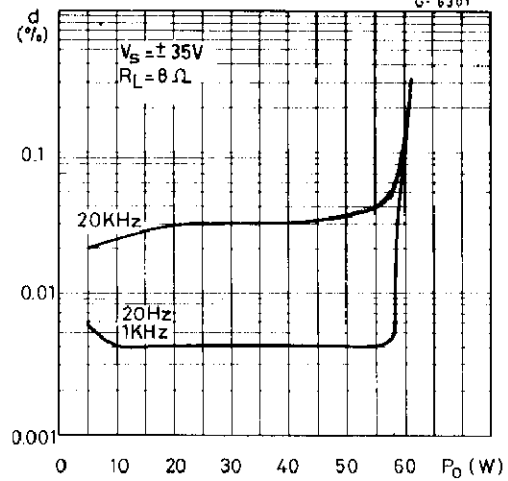

Figure 5 : Supply Voltage Rejection vs. Frequency.

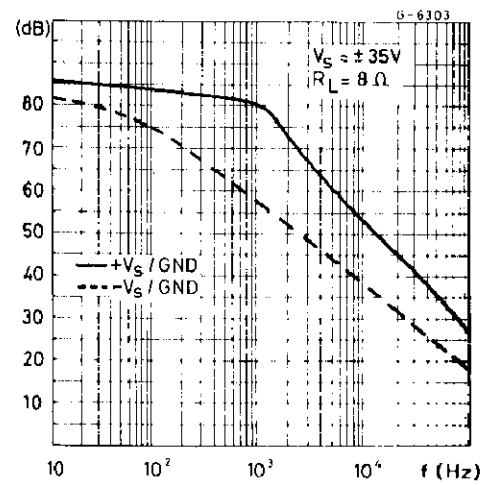

Figure 7 : Quiescent Current vs.  $T_{amb}$ .

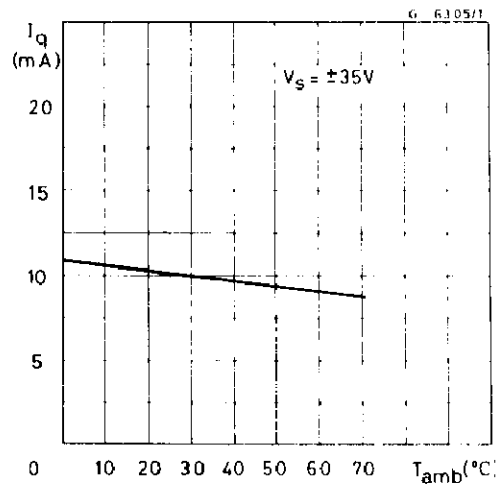

Figure 8 : Total Dissipated Power vs. Output Power (\*).

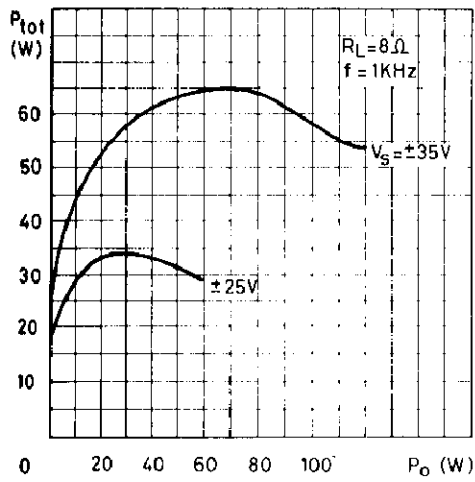

Figure 9 : Efficiency vs. Output Power (\*).

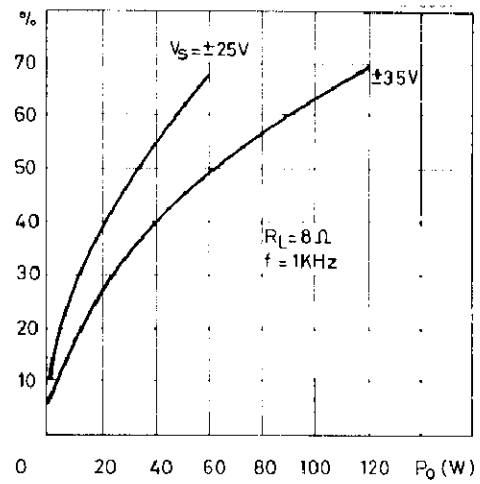
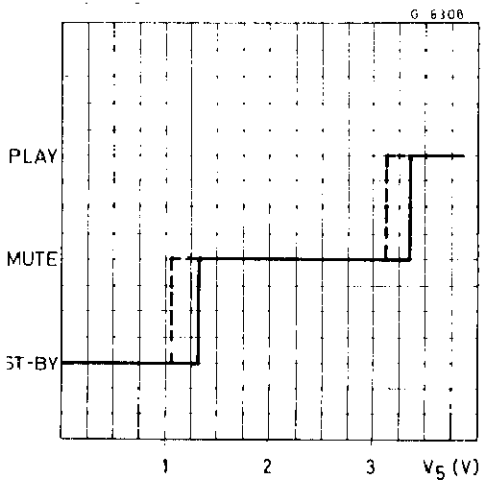

Figure 10 : Play-mute Standby Operation.



(\* ) Complete circuit



Figure 11 : Application Circuit Using Power Transistors.

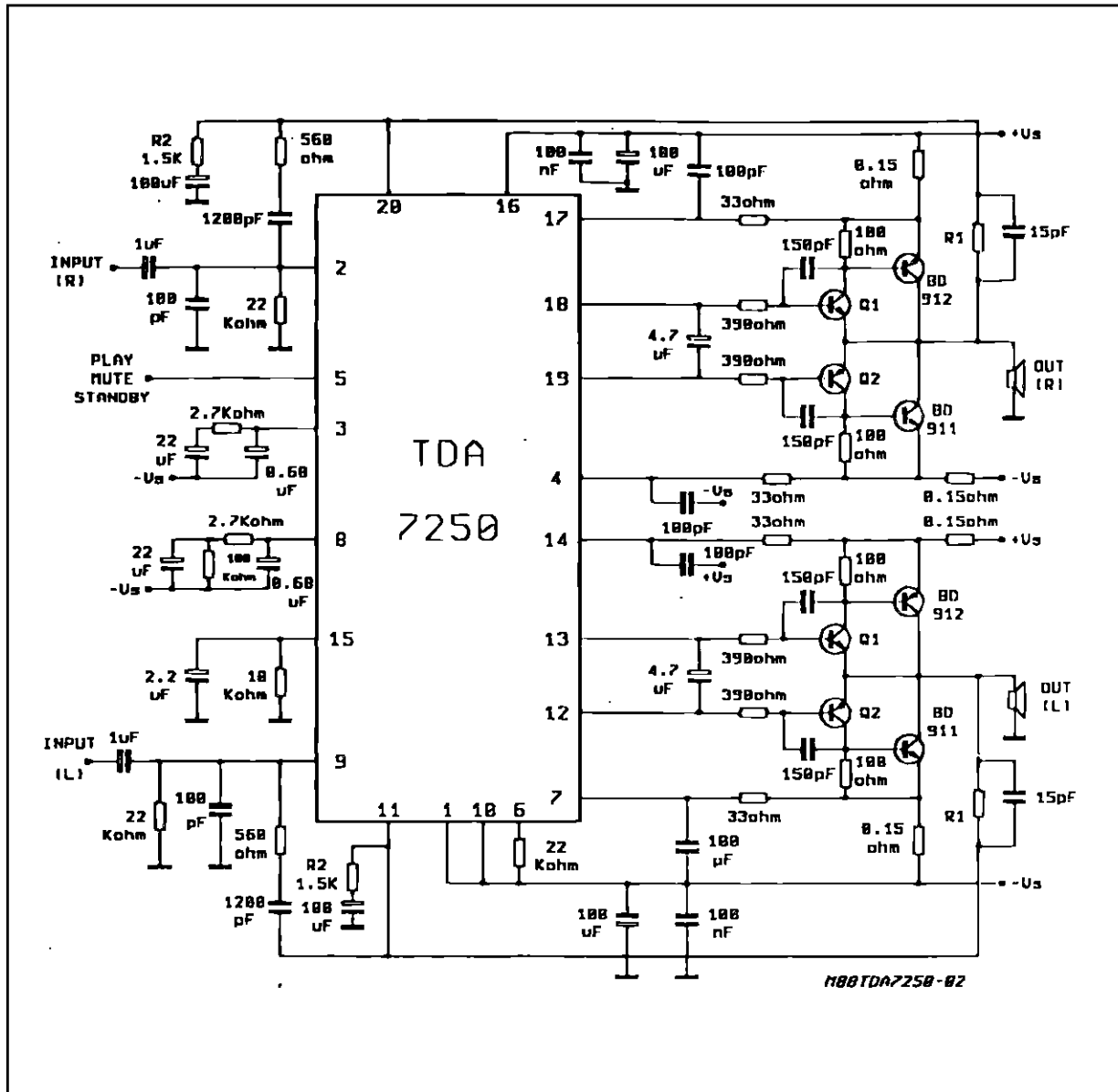

Figure 12 : Suggested Transistor Types for Various Loads and Powers.

$R_L = 8 \Omega$

15W	+30W	+50W	+70W
BDX 53/54A	BDX 53/54B	BDW 93/94B	TIP 142/147

$T_L = 4 \Omega$

30W	+50W	+90W	+130W
BDW 93/94A	BDW 93/94B	BDV 64/65B	MJ 11013/11014

# TDA7250

## DIP20 PACKAGE MECHANICAL DATA

DIM.	mm			inch		
	MIN.	TYP.	MAX.	MIN.	TYP.	MAX.
a1	0.51			0.020		
B	0.85		1.40	0.033		0.055
b		0.50			0.020	
b1	0.38		0.50	0.015		0.020
D			24.80			0.976
E		8.80			0.346	
e		2.54			0.100	
e3		22.86			0.900	
F			7.10			0.280
l			5.10			0.201
L		3.30			0.130	
Z			1.27			0.050

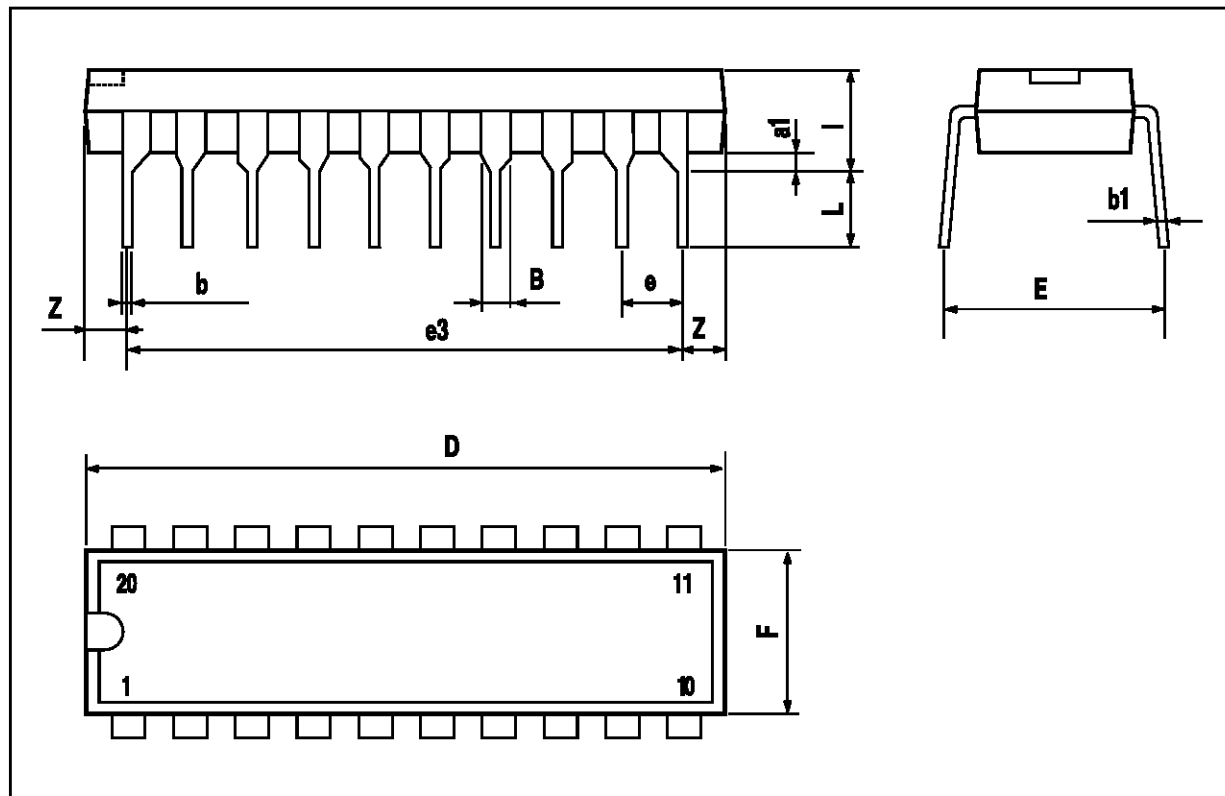

Information furnished is believed to be accurate and reliable. However, SGS-THOMSON Microelectronics assumes no responsibility for the consequences of use of such information nor for any infringement of patents or other rights of third parties which may result from its use. No license is granted by implication or otherwise under any patent or patent rights of SGS-THOMSON Microelectronics. Specifications mentioned in this publication are subject to change without notice. This publication supersedes and replaces all information previously supplied. SGS-THOMSON Microelectronics products are not authorized for use as critical components in life support devices or systems without express written approval of SGS-THOMSON Microelectronics.

© 1995 SGS-THOMSON Microelectronics - All Rights Reserved

SGS-THOMSON Microelectronics GROUP OF COMPANIES

Australia - Brazil - France - Germany - Hong Kong - Italy - Japan - Korea - Malaysia - Malta - Morocco - The Netherlands - Singapore - Spain - Sweden - Switzerland - Taiwan - Thailand - United Kingdom - U.S.A.