

5.1V +8V REGULATOR WITH DISABLE AND RESET

ADVANCE DATA

- OUTPUT CURRENTS UP TO 0.75A
- FIXED PRECISION OUTPUT 1 VOLTAGE
5.1V ± 2%
- FIXED PRECISION OUTPUT 2 VOLTAGE
8V ± 2%
- OUTPUT 1 WITH RESET FACILITY
- OUTPUT 2 WITH DISABLE BY TTL INPUT
- SHORT CIRCUIT PROTECTION AT BOTH
OUTPUTS
- THERMAL PROTECTION
- LOW DROP OUTPUT VOLTAGE

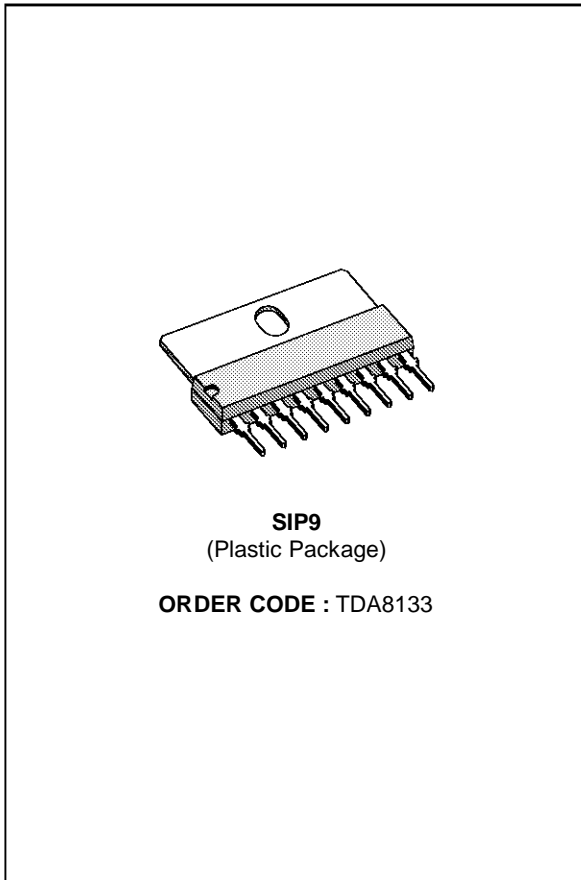

DESCRIPTION

The TDA8133 is a monolithic dual positive voltage regulator designed to provide fixed precision output voltages of 5.1V and 8V at currents up to 0.75A.

An internal reset circuit generates a reset pulse when the output 1 decrease below the regulated voltage value.

Output 2 can be disabled by TTL input.

Short circuit and thermal protections are included in all the versions.

PIN CONNECTIONS

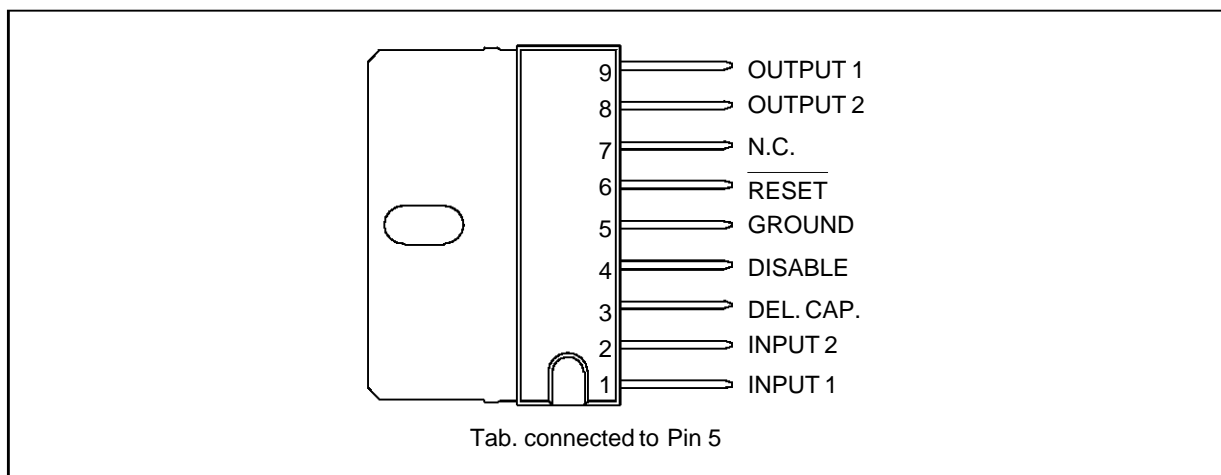

8133-01.EPS

TDA8133

BLOCK DIAGRAM

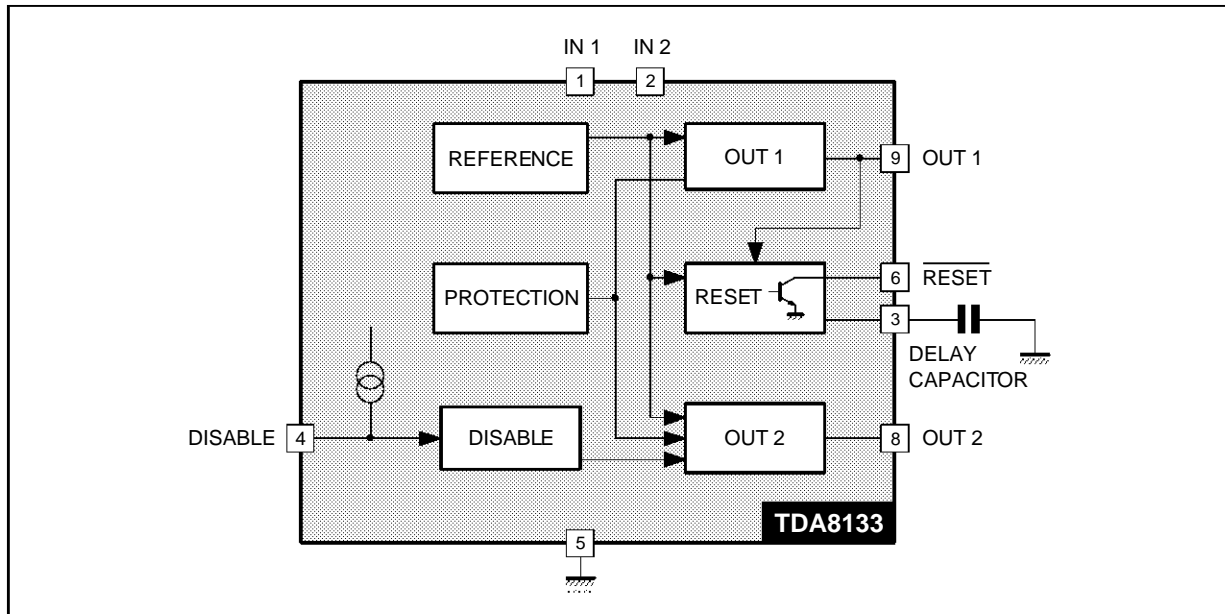

8133-02.EPS

ABSOLUTE MAXIMUM RATINGS

| Symbol | Parameter | Value | Unit |
|------------|-------------------------|--------------------|------|
| V_{IN} | DC Input Voltage Pin 1 | 20 | V |
| V_{DIS} | Disable Input Voltage | 20 | V |
| V_{RST} | Output Voltage at Pin 6 | 20 | V |
| $I_{O1,2}$ | Output Currents | Internally Limited | |
| P_t | Power Dissipation | Internally Limited | |
| T_{stg} | Storage Temperature | -65 to +150 | °C |
| T_j | Junction Temperature | 0 to +150 | °C |

8133-01.TBL

THERMAL DATA

| Symbol | Parameter | Value | Unit |
|---------------|---|-------|------|
| $R_{th(j-c)}$ | Maximum Thermal Resistance Junction-case | 8 | °C/W |
| $R_{th(j-a)}$ | Maximum Thermal Resistance Junction-ambient | 60 | °C/W |
| T_j | Maximum Recommended Junction Temperature | 130 | °C |

8133-02.TBL

ELECTRICAL CHARACTERISTICS ($V_{IN1} = 7V$, $V_{IN2} = 10V$, $T_j = 25^\circ C$, unless otherwise specified)

| Symbol | Parameter | Test Conditions | Min. | Typ. | Max. | Unit |
|--------------|--|---|---------|----------|------------|-----------------|
| V_{O1} | Output Voltage | $I_{O1} = 10mA$ | 5 | 5.1 | 5.2 | V |
| V_{O2} | Output Voltage | $I_{O2} = 10mA$ | 7.84 | 8 | 8.16 | V |
| V_{O1} | Output Voltage | $7V < V_{IN1} < 14V$ | 4.9 | | 5.3 | V |
| V_{O2} | Output Voltage | $10V < V_{IN2} < 14V$ $5mA < I_{O1,2} < 750mA$ | 7.7 | | 8.3 | V |
| $V_{IO1,2}$ | Dropout Voltage | $I_{O1,2} = 750mA$ | | | 1.4 | V |
| $V_{O1,2LI}$ | Line Regulation | $7V < V_{IN1} < 14V$ $10V < V_{IN2} < 14V$ $I_{O1,2} = 200mA$ | | | 50 80 | mV mV |
| $V_{O1,2LO}$ | Load Regulation | $5mA < I_{O1} < 0.6A$ $5mA < I_{O2} < 0.6A$ | | | 100 160 | mV mV |
| I_Q | Quiescent Current | $I_{O1} = 10mA$ Output 2 Disabled | | | 2 | mA |
| V_{O1RST} | Reset Threshhold Voltage | $K = V_{O1}$ | K - 0.4 | K - 0.25 | K - 0.1 | V |
| V_{RTH} | Reset Threshhold Hysteresis | See circuit description | 20 | 50 | 75 | mV |
| t_{RD} | Reset Pulse Delay | $C_e = 100nF$ See circuit description | | 25 | | ms |
| V_{RL} | Saturation Voltage in Reset Condition | $I_5 = 5mA$ | | | 0.4 | V |
| I_{RH} | Leakage Current in Normal Condition at Pin 6 | $V_5 = 10V$ | | | 10 | μA |
| $K_{O1,2}$ | Output Voltage Thermal Drift | $T_j = 0 \text{ to } 125^\circ C$ $K_O = \frac{\Delta V_O \cdot 10^6}{\Delta T \cdot V_O}$ | | 100 | | ppm/ $^\circ C$ |
| $I_{O1,2SC}$ | Short Circuit Output Current | $V_{IN1} = 7V$, $V_{IN2} = 10V$ $V_{IN1,2} = 16V$ (see Note) | | | 1.6 1 | A A |
| V_{DISH} | Disable Voltage High (out 2 active) | | 2 | | | V |
| V_{DISL} | Disable Voltage Low (out 2 disabled) | | | | 0.8 | V |
| I_{DIS} | Disable Bias Current | $0V < V_{DIS} < 7V$ | -100 | | 2 | μA |
| T_{jsd} | Junction Temperature for Thermal Shut Down | | | 145 | | $^\circ C$ |

8133-03.TBL

Note : Safe permanent short-circuit is only guaranteed for input voltages up to 16V.

CIRCUIT DESCRIPTION

The TDA8133 is a dual voltage regulator with Reset and Disable.

The two regulation parts are supplied from one voltage reference circuit trimmed by zener zap during EWS test.

Since the supply voltage of this last is connected at Pin 1 (V_{IN1}), the regulator 2 will not work if Pin 1 is not supplied.

The outputs stage have been realized in darlington configuration with a drop typical 1.2V.

The disable circuit, switch-off the output 2 if a voltage lower than 0.8V is applied at Pin 4.

The Reset circuit checks the voltage at the output 1. If this one goes below $V_{OUT} - 0.25V$ (4.85V typ.), the comparator "a" (see Figure 1) discharges rapidly the capacitor C_e and the reset output goes at once Low. When the voltage at the out1 rises above $V_{OUT} - 0.2V$ (4.9V typ.), the voltage V_{ce} increases linearly to 2.5V corresponding to a delay t_d following the law : $t_1 = \frac{C_e \cdot 2.5V}{10\mu A}$ (see Figure 2), then the reset output goes high again. To avoid glitches in the reset output, the second comparator "b" has a large hysteresis (1.9V).

Figure 1

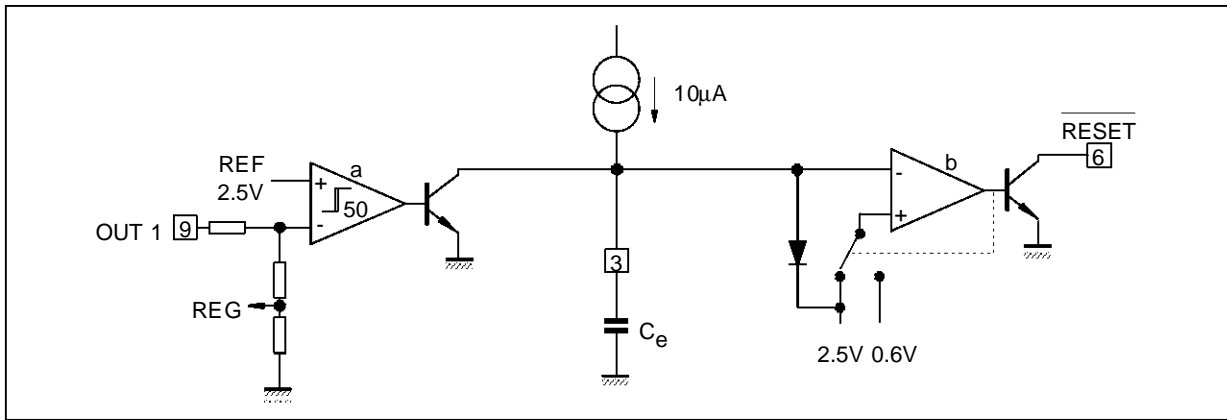

8133-03.EPS

Figure 2

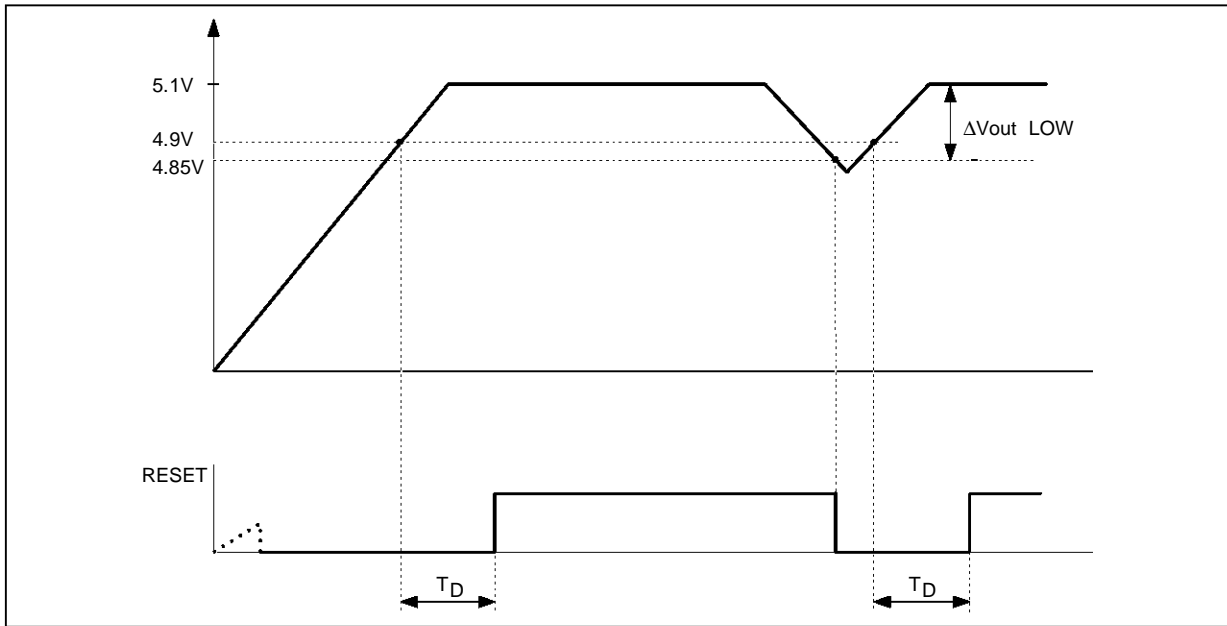

8133-04.EPS

TYPICAL APPLICATION

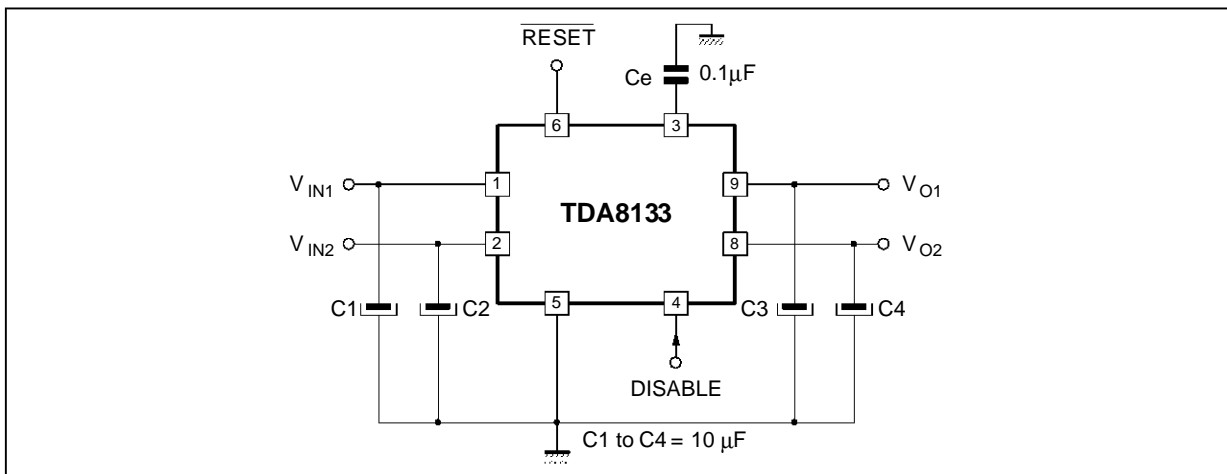

8133-05.EPS

PACKAGE MECHANICAL DATA

9 PINS - PLASTIC SIP

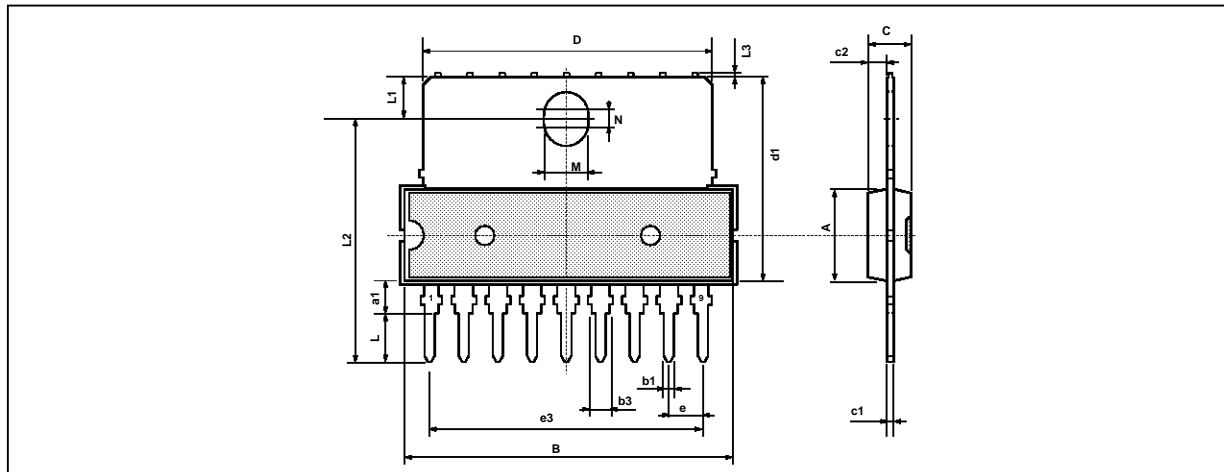

PM-SIP9.EPS

| Dimensions | Millimeters | | | Inches | | |
|------------|-------------|-------|------|--------|-------|-------|
| | Min. | Typ. | Max. | Min. | Typ. | Max. |
| A | | | 7.1 | | | 0.280 |
| a1 | 2.7 | | 3 | 0.106 | | 0.118 |
| B | | | 24.8 | | | 0.976 |
| b1 | | 0.5 | | | 0.020 | |
| b3 | 0.85 | | 1.6 | 0.033 | | 0.063 |
| C | | 3.3 | | | 0.130 | |
| c1 | | 0.43 | | | 0.017 | |
| c2 | | 1.32 | | | 0.052 | |
| D | | | 21.2 | | | 0.835 |
| d1 | | 14.5 | | | 0.571 | |
| e | | 2.54 | | | 0.100 | |
| e3 | | 20.32 | | | 0.800 | |
| L | 3.1 | | | 0.122 | | |
| L1 | | 3 | | | 0.118 | |
| L2 | | 17.6 | | | 0.693 | |
| L3 | | | 0.25 | | | 0.010 |
| M | | 3.2 | | | 0.126 | |
| N | | 1 | | | 0.039 | |

SIP9.TEL

Information furnished is believed to be accurate and reliable. However, SGS-THOMSON Microelectronics assumes no responsibility for the consequences of use of such information nor for any infringement of patents or other rights of third parties which may result from its use. No licence is granted by implication or otherwise under any patent or patent rights of SGS-THOMSON Microelectronics. Specifications mentioned in this publication are subject to change without notice. This publication supersedes and replaces all information previously supplied. SGS-THOMSON Microelectronics products are not authorized for use as critical components in life support devices or systems without express written approval of SGS-THOMSON Microelectronics.

© 1994 SGS-THOMSON Microelectronics - All Rights Reserved

Purchase of I²C Components of SGS-THOMSON Microelectronics, conveys a license under the Philips I²C Patent. Rights to use these components in a I²C system, is granted provided that the system conforms to the I²C Standard Specifications as defined by Philips.

SGS-THOMSON Microelectronics GROUP OF COMPANIES

Australia - Brazil - China - France - Germany - Hong Kong - Italy - Japan - Korea - Malaysia - Malta - Morocco
The Netherlands - Singapore - Spain - Sweden - Switzerland - Taiwan - Thailand - United Kingdom - U.S.A.