

H/V PROCESSOR FOR TTL V.D.U

HORIZONTAL SECTION

- SYNCHRONIZATION INPUT : TTL COMPATIBLE, NEGATIVE EDGE TRIGGERED
- SYNCHRONIZATION INDEPENDENT FROM DUTY CYCLE TIME
- OSCILLATOR : FREQUENCY RANGE FROM 15kHz to 100kHz
- HORIZONTAL OUTPUT PULSE SHAPER AND SHIFTER
- PHASE COMPARATOR BETWEEN SYNCHRO AND OSCILLATOR (PLL1)
- PHASE COMPARATOR BETWEEN FLYBACK AND OSCILLATOR (PLL2)
- INTERNAL VOLTAGE REGULATOR
- DC COMPATIBLE CONTROLS FOR PHASE AND FREQUENCY
- HORIZONTAL OUTPUT DUTY CYCLE : 41%

VERTICAL SECTION

- SYNCHRONIZATION INPUT : TTL COMPATIBLE, NEGATIVE EDGE TRIGGERED
- SYNCHRONIZATION INDEPENDENT FROM DUTY CYCLE TIME
- OSCILLATOR : FREQUENCY RANGE FROM 30Hz to 120Hz
- RAMP GENERATOR WITH VARIABLE GAIN STAGE
- VERTICAL RAMP VOLTAGE REFERENCE
- INTERNAL VOLTAGE REGULATOR
- DC COMPATIBLE CONTROLS FOR FREQUENCY, AMPLITUDE AND LINEARITY

DESCRIPTION

The TDA9102C is a monolithic integrated circuit for horizontal and vertical sync processing in monochrome and color video displays driven by input TTL compatible signals.

The TDA9102C is supplied in a 20 pin dual in line package with pin 11 connected to ground and used for heatsinking.

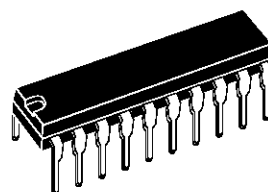

POWERDIP20 (0.4)
(Plastic package)

ORDER CODES : TDA9102C

PIN CONNECTIONS

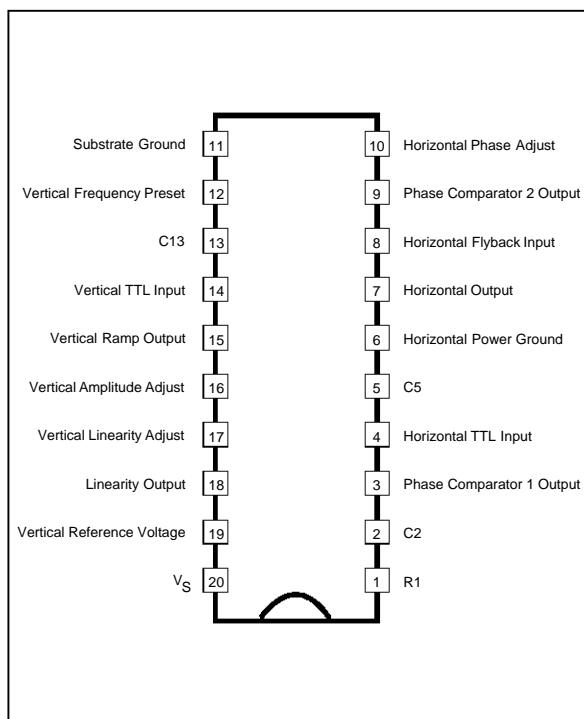

9102001.EPS

BLOCK DIAGRAM

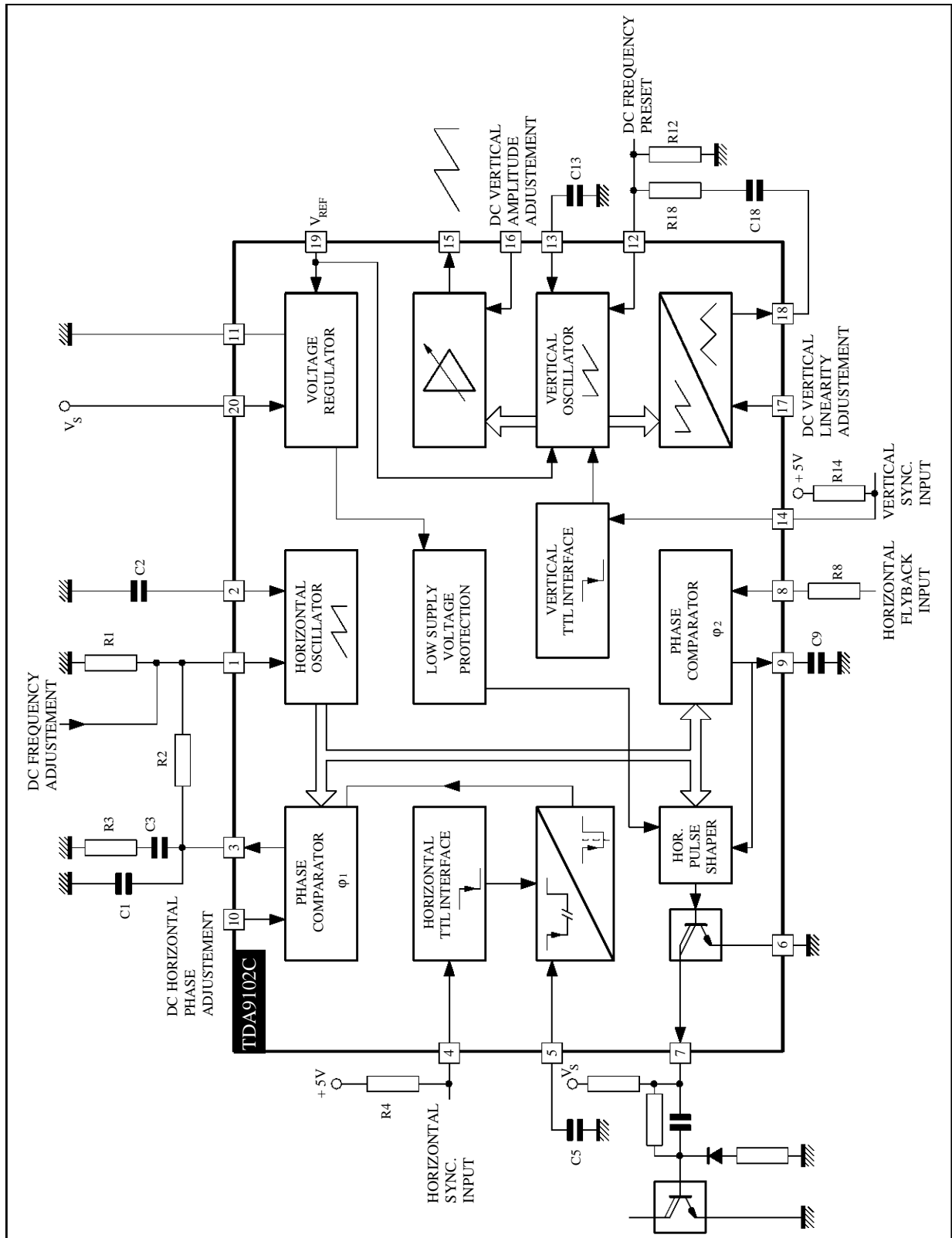

91020S2.EPS

ABSOLUTE MAXIMUM RATINGS

Symbol	Parameter	Value	Unit
V _S	Supply Voltage	18	V
V _{SYNC}	Sync Input Peak Voltage	+ V _S	V
I _{OH}	Output Sinking Peak Current (Pin 7 ; t < 3μs)	2	A
I ₁₅	Output Current (Pin 15)	- 10	mA
I ₁₉	Output Current (Pin 19)	- 10	mA
P _{TOT}	Total power dissipation <ul style="list-style-type: none"> • T_{amb} < 70°C • T_{pin} < 90°C 	1.4 1.5	W W
T _{STG} , T _J	Storage and Junction Temperature	- 40 to 150	°C

9102001.TBL

THERMAL DATA

Symbol	Parameter	Value	Unit
R _{TH(J-C)}	Junction-case Thermal Resistance	40	°C/W
R _{TH(J-A)}	Junction-ambient Thermal Resistance	55	°C/W

9102002.TBL

ELECTRICAL CHARACTERISTICS

(T_{AMB} = 25°C, V_S = 12V, refer to the test circuits, unless otherwise specified)

Symbol	Parameter	Test conditions	Min.	Typ.	Max.	Unit
--------	-----------	-----------------	------	------	------	------

HORIZONTAL SECTION

V _S	Supply Voltage Range		10.5	12	15.5	V
I _S	Supply Current			40	70	mA
V ₁	Voltage Reference at Pin 1	I ₁ = 0.5mA	3.2	3.5	3.8	V
I ₁	Current at Pin 1		- 1			mA
V ₂	Voltage Swing at Pin 2		3.7	4	4.3	V _{PP}
K ₀	Free Running Frequency Constant	f ₀ = 1/(K ₀ x R1 x C2)	2.8	3.04	3.2	
V ₃ - V ₁	Control Voltage Range	(See technical note 1)	1.6	2.5		V
I ₃	Peak Control Current			3		mA
K ₃	Gain Phase Comparator φ1 K ₃ = 2 x I ₃ / 360			17		$\frac{\mu A}{\text{degree}}$
V ₄	Sync Threshold Input (neg. edge)	<ul style="list-style-type: none"> • Sync high • Sync low 	2		8 0.8	V V
I ₄	Current at Pin 4	<ul style="list-style-type: none"> • Input high • Input low 	- 10		10	μA μA
T ₄	Input Pulse Duration T = 1/f _H	@ f _H = 27.64kHz	1		0.9T	μs
V ₅	Monostable Threshold		5.6	6	6.4	V
t ₅	Internal Pulse Width (t ₅ = C5 x V ₅ / I ₅)	C5 = 220 pF (see technical note 2)		3.6		μs
t ₇	Output Pulse Duration (low) - T = 1/f _H	f _H = 27kHz f _H = 70kHz	0.38T 0.35T	0.41T 0.39T	0.44T 0.43T	μs μs
V _{7 sat}	Output Saturation Voltage	I ₇ = 600 mA		1.2	2.5	V
t _D	Permissible delay between output pulse leading edge and flyback pulse leading edge (for keeping a constant duty cycle) ; T = $\frac{1}{f_H}$	See technical note 4 @ f _H = 27kHz	0.41 T - t _{FLY}			s
I _{FLY}	Flyback Input Current at Pin 8	<ul style="list-style-type: none"> • Flyback On • Flyback Off 	0.7 -1		2	mA mA
V ₈	Clamp voltage at Pin 8	<ul style="list-style-type: none"> • I₈ = 1mA • I₈ = - 1mA 	0.6		- 0.6	V V
I ₈	Current for switching low the output pulse		0.7		2	mA
I ₉	Peak control current			0.9		mA

9102003.TBL

ELECTRICAL CHARACTERISTICS (continued)

(T_{AMB} = 25°C, V_S = 12V, refer to the test circuits, unless otherwise specified)

Symbol	Parameter	Test conditions	Min.	Typ.	Max.	Unit
HORIZONTAL SECTION						
K ₉	Phase sensitivity at Pin 9	(See technical note 3)		67.5		$\frac{\text{degree}}{\text{V}}$
V ₁₀	Control voltage range		0.5		4.5	V
K ₁₀	Phase control sensitivity at Pin 10		20	22.5	25	$\frac{\text{degree}}{\text{V}}$
HADJ	Horizontal phase adjustment for V ₁₀ varying from 0.5 to 4.5V (27.64kHz)	Zero degree phase: flyback centered on the middle of the pulse at Pin 5	- 45		+ 45	degree
K ₁	Phase jitter constant (jitter = $\frac{K_1}{10^6 \cdot f_H}$)			100	150	ppm
K ₂	Frequency drift versus supply voltage $K_2 = \frac{dF \cdot 10^6}{dV \cdot f_H}$	V _S = 10.5V to 15.5V			400	$\frac{\text{ppm}}{\text{V}}$

VERTICAL SECTION

V ₁₂	Voltage reference at Pin 12		3.2	3.5	3.8	V
$\frac{I_{13}}{I_{12}}$	Current gain at Pin 13	I ₁₂ = 100µA (I ₁₂ max. = 200µA)	0.94	1	1.06	
V ₁₃	Typical Vertical Sawtooth Amplitude (Pin 13) for Center Frequency	To be adjusted by I ₁₂		4		V _{PP}
t _{FALL}	Discharge time at Pin 13	C ₁₈ = 0.22 µF, V ₁₃ = 4V _{PP}		10	22	µs
f _{VL}	Maximum Vertical Frequency	Vertical Sync Low C _{Pin 13} = 220nF, R _{Pin 12} = 58kΩ		84		Hz
f _{VH}	Minimum Vertical Frequency	Vertical Sync High C _{Pin 13} = 220nF, R _{Pin 12} = 58kΩ		56		Hz
K ₁₄	Synchro window constant $t_s = \frac{K_{14}}{f_v}$	(See technical note 6)		0.333		
V ₁₄	Sync input threshold (negative edge)	● Sync high ● Sync Low	2		8 0.8	V V
I ₁₄	Current at Pin 14	● Input high ● Input Low V ₁₄ = 0.8V	- 10		10	µA µA
t ₁₄	Input pulse duration $T = \frac{1}{f_v}$	@ f _v = 64.75Hz	10		0.5T	µs
V ₁₅	Average value of voltage on Pin 15	V ₁₃ = 4V _{PP} , V ₁₆ = 2.5V		4		V
I _{15I}	Output current at Pin 15				1	mA
K ₁₅	Buffer gain constant at Pin 15 V _{15PP} = K ₁₅ · V _{13PP}	V ₁₆ = 2.5V		0.95		
K ₁₆	Buffer variable gain constant at Pin 15 : $K_{16} = \frac{\Delta V_{15PP}}{\Delta V_{16} \cdot V_{13PP}}$	2.5V < V ₁₆ < 4.5V 0.5V < V ₁₆ < 2.5V		0.1 0.1		V^{-1} V^{-1}
I ₁₆	Input bias current at Pin 16	V ₁₆ = 0.5V	- 50			µA
I ₁₇	Input bias current at Pin 17	V ₁₇ = 4.5V			50	µA
V ₁₈	Average voltage at Pin 18 : $V_{18} = 2 + \frac{V_{18PP}}{2}$	V ₁₇ = 3.5V, R ₁₈ not connected		3		V
K ₁₈	Linearity correction constant : $K_{18} = \frac{\Delta V_{18PP}}{\Delta V_{17}}$	V _{13PP} = 4V, 1.5V < V ₁₇ < 4.5V		1		
V ₁₉	Voltage reference at Pin 19	(See technical note 5)	7.6	8	8.4	V
I _{19I}	Current at Pin 19				2	mA

9102004.TBL

ELECTRICAL CHARACTERISTICS (continued)

($T_{AMB} = 25^{\circ}C$, $V_S = 12V$, refer to the test circuits, unless otherwise specified)

Symbol	Parameter	Test conditions	Min.	Typ.	Max.	Unit
VERTICAL SECTION						
K_{17}	Frequency drift versus supply voltage $K_{17} = \frac{dF \cdot 10^6}{dV \cdot f_V}$	$V_S = 10.5V$ to $15.5V$			300	$\frac{ppm}{V}$

Technical note 1

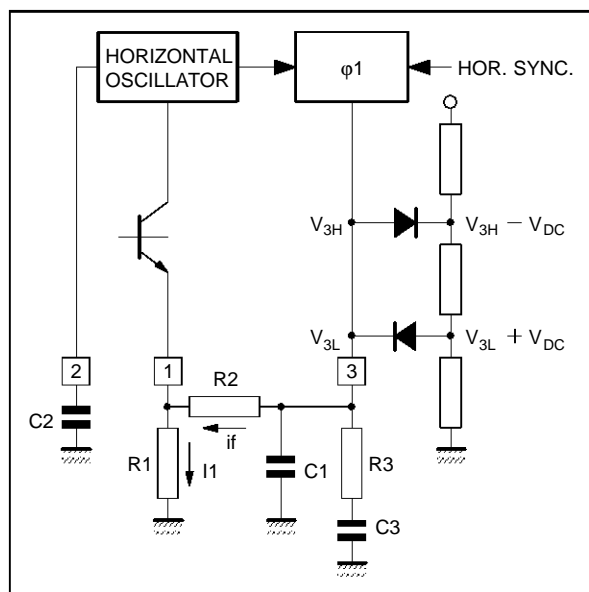

$f_H (nom) = 26.8 \text{ kHz}$
 $R1 = 6.8k \Omega$
 $R2 = 56 \text{ k}\Omega$
 $C2 = 1.8 \text{ nF}$

$$f_{pull-in} = f_H (nom) \frac{|V_3 - V_1| / R2}{V_1 / R1} = f_H (nom) \frac{I_f}{I_o} \quad (A)$$

where: $V_1 = 3.5V$ and $|V_3 - V_1|$ is the control voltage range.

The voltage at Pin 3 is limited by two clamping diodes at the voltage V_{3H} and V_{3L} . When the PLL1 is synchronized and perfectly tuned, $V_3 = V_1$.

Remark: The value of C2 influences the horizontal oscillator free running frequency; it doesn't effect the relative pull-in range. If the horizontal frequency is changed by using R1, the pull-in range changes accordingly with the formula (A).

Technical note 2

The internal pulse "ts", is generated by the current generator "I5" charging the external capacitor "C5", according with the formula (B):

$$t_s = \frac{C5 \cdot V_5}{I_5} \quad (B), \quad t_s = \frac{T_H}{12} \quad \text{is recommended.}$$

Technical note 3

$K_9 = 67.5$ degrees/volt represents the slope of the oscillator charging period of the waveform at

Pin 2:

$$K_9 = \frac{360 \times 0.75}{4} \frac{\text{degree}}{V}$$

Technical note 4

The second PLL can recover the storage of horizontal output stage maintaining a constant duty cycle till the trailing edge of the output pulse gets the trailing edge of the flyback pulse. From this point on, only the leading edge of the output pulse will be shifted covering a total phase shift of: $0.30T$; overcoming this value, it will produce a notch in the output pulse (@ $f_H = 27kHz$).

Technical note 5

The voltage reference at Pin 19 can be used to polarize the DC operating point of the vertical booster. This voltage corresponds to the double of the mean value voltage of the vertical sawtooth at Pin 13.

Technical note 6

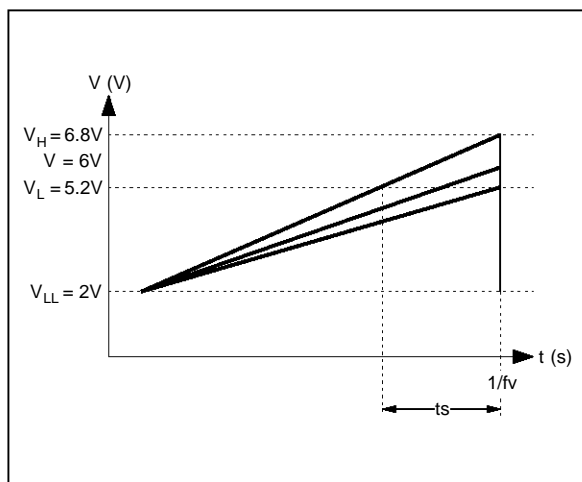

$$\frac{V_H - V_L}{t_s} = \frac{V_H - V_{LL}}{1/f_v}$$

$$t_s = \frac{(V_H - V_L)}{(V_H - V_{LL})} \frac{1}{f_v} = \frac{K_{14}}{f_v}$$

APPLICATION DIAGRAM (with TDA8172)

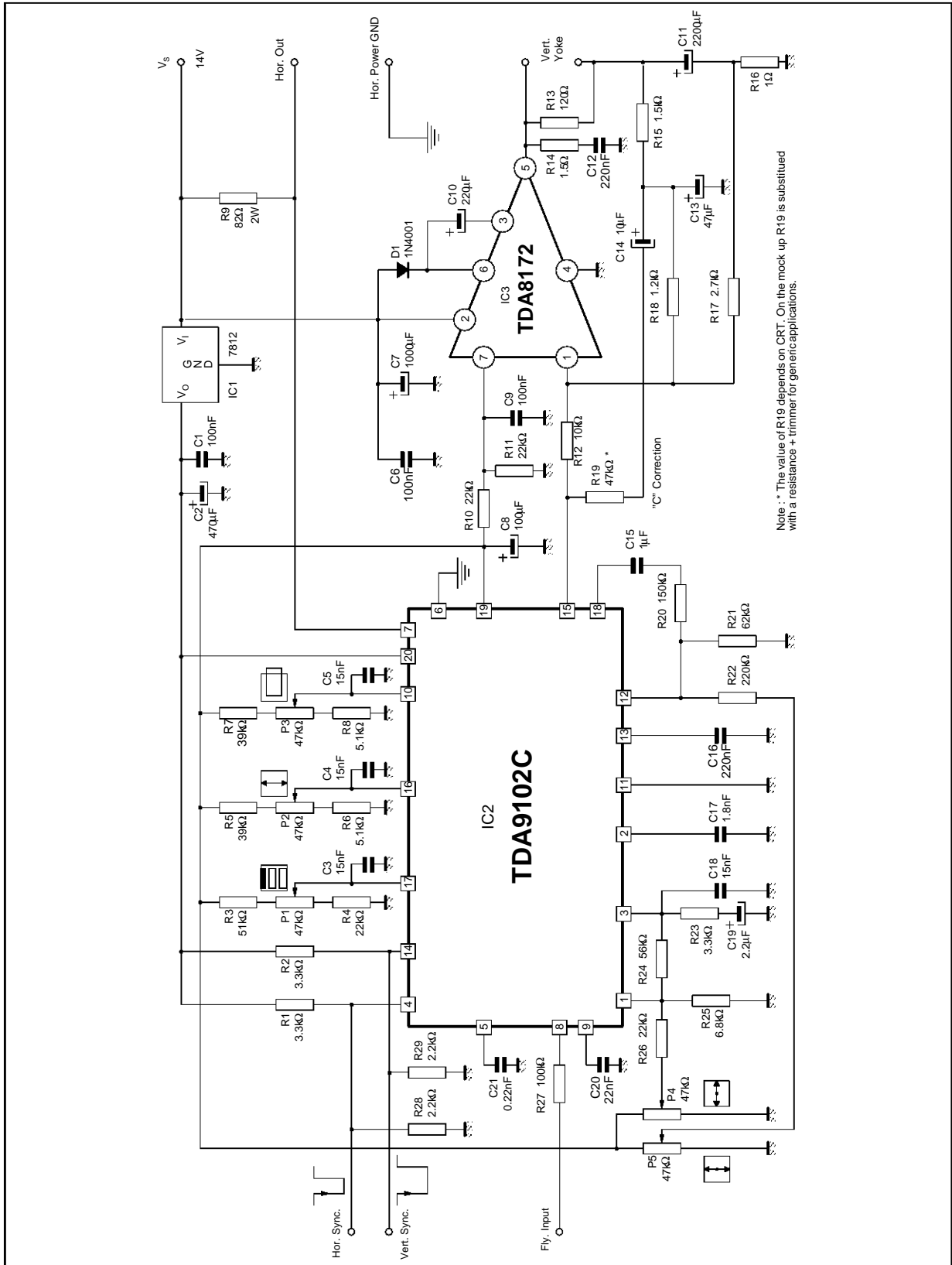

Note : * The value of R19 depends on CRT. On the mock up R19 is substituted with a resistance + trimmer for generic applications.

PACKAGE MECHANICAL DATA

20 PINS - PLASTIC DIP

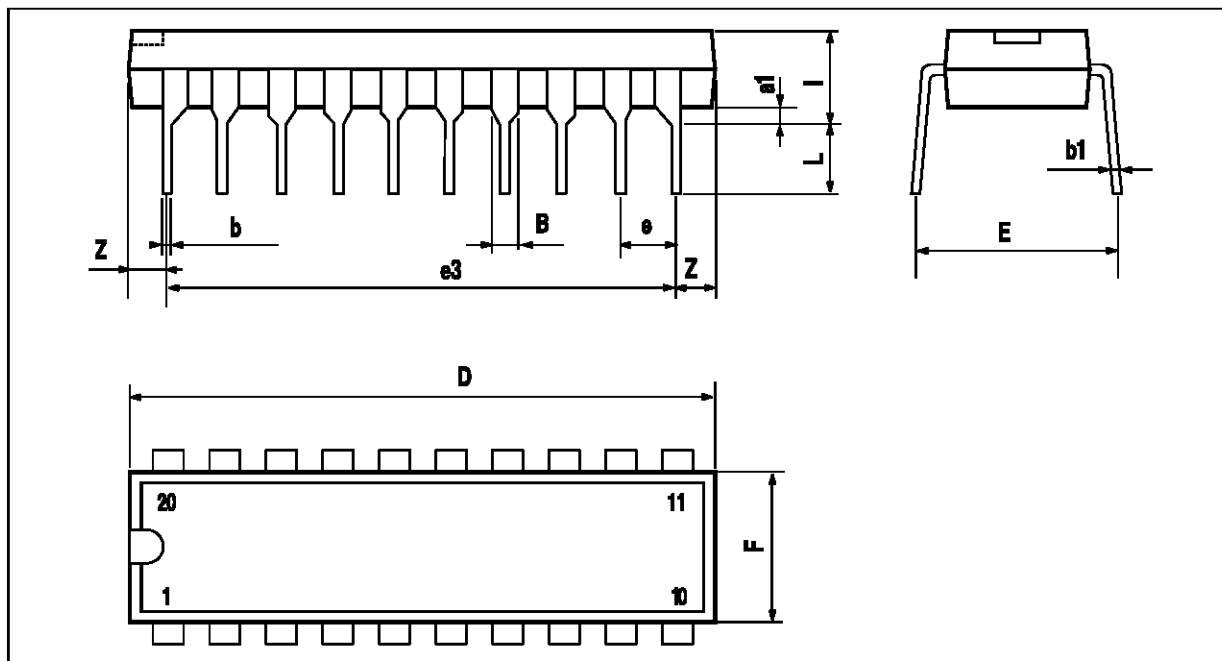

PM-DIP20.EPS

Dimensions	Millimeters			Inches		
	Min.	Typ.	Max.	Min.	Typ.	Max.
a1	0.51			0.020		
B	0.85		1.40	0.033		0.055
b		0.50			0.020	
b1	0.38		0.50	0.015		0.020
D			24.80			0.976
E		8.80			0.346	
e		2.54			0.100	
e3		22.86			0.900	
F			7.10			0.280
I			5.10			0.201
L		3.30			0.130	
Z			1.27			0.050

DIP20PW.TBL

Information furnished is believed to be accurate and reliable. However, SGS-THOMSON Microelectronics assumes no responsibility for the consequences of use of such information nor for any infringement of patents or other rights of third parties which may result from its use. No licence is granted by implication or otherwise under any patent or patent rights of SGS-THOMSON Microelectronics. Specifications mentioned in this publication are subject to change without notice. This publication supersedes and replaces all information previously supplied. SGS-THOMSON Microelectronics products are not authorized for use as critical components in life support devices or systems without express written approval of SGS-THOMSON Microelectronics.

© 1996 SGS-THOMSON Microelectronics - All Rights Reserved

Purchase of I²C Components of SGS-THOMSON Microelectronics, conveys a license under the Philips I²C Patent. Rights to use these components in a I²C system, is granted provided that the system conforms to the I²C Standard Specifications as defined by Philips.

SGS-THOMSON Microelectronics GROUP OF COMPANIES

Australia - Brazil - Canada - China - France - Germany - Hong Kong - Italy - Japan - Korea - Malaysia - Malta - Morocco
The Netherlands - Singapore - Spain - Sweden - Switzerland - Taiwan - Thailand - United Kingdom - U.S.A.