

3V AM / FM IF + MPX (for Digital Tuning System)

TA8132AN, TA8132AF are the AM / FM IF + MPX system ICs, which are designed for DTS Radios. These are included many functions and these can be used for Digital Tuning System with IF Counter.

FEATURES

- Built-in AM / FM IF and FM Stereo PLL Multiplex Decoder.
- Suitable for combination with Digital Tuning System which is included IF Counter.
 - One terminal type AM / FM IF Count Output (Auto Stop Signal) for IF Counter of Digital Tuning System.

FM : 10.7MHz	}	changeable by external switch
1.3375MHz (1 / 8 dividing)		
AM : 450kHz		
 - Built-in Mute Circuit for IF Count Output.

It is controlled by the IF Request Signal from Digital Tuning System,

Pin② level : High→Come out
Low →Non output
 - Adjustable for IF Count Output Sensitivity by External Resistance of pin②.
- For adopting Ceramic Discriminator and Ceramic Resonator, it is not necessary to adjust the FM Quad Detector Circuit and MPX VCO Circuit.
- Built-in One terminal type AM Low Cut Circuit.
- Operating Supply Voltage Range (Ta = 25°C)
VCC (opr.) = 1.8V~8.0V

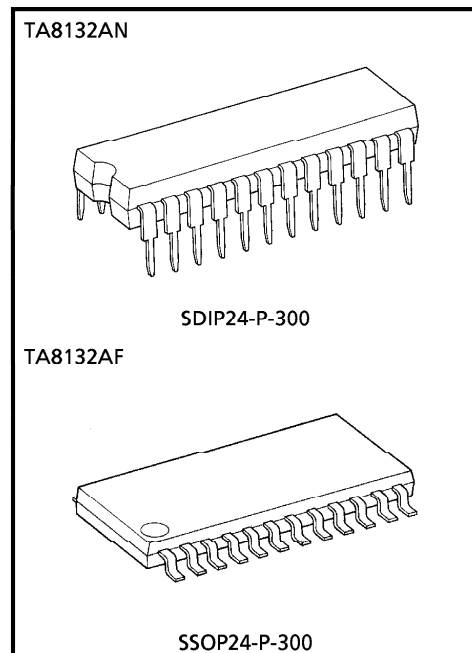

Weight SDIP24-P-300 : 1.2g (Typ.)
SSOP24-P-300 : 0.31g (Typ.)

① The information contained herein is presented only as a guide for the applications of our products. No responsibility is assumed by TOSHIBA CORPORATION for any infringements of intellectual property or other rights of the third parties which may result from its use. No license is granted by implication of otherwise under any intellectual property or other rights of TOSHIBA CORPORATION or others.

② These TOSHIBA products are intended for use in general commercial applications (office equipment, communication equipment, measuring equipment, domestic appliances, etc.). please make sure that you consult with us before you use these TOSHIBA products in equipment which requires extraordinarily high quality and/or reliability, and in equipment which may involve life threatening or critical application, including but not limited to such uses as atomic energy control, airplane or spaceship instrumentation, traffic signals, medical instrumentation, combustion control, all types of safety devices, etc. TOSHIBA cannot accept and hereby disclaims liability for any damage which may occur in case the TOSHIBA products are used in such equipment or applications without prior consultation with TOSHIBA.

BLOCK DIAGRAM

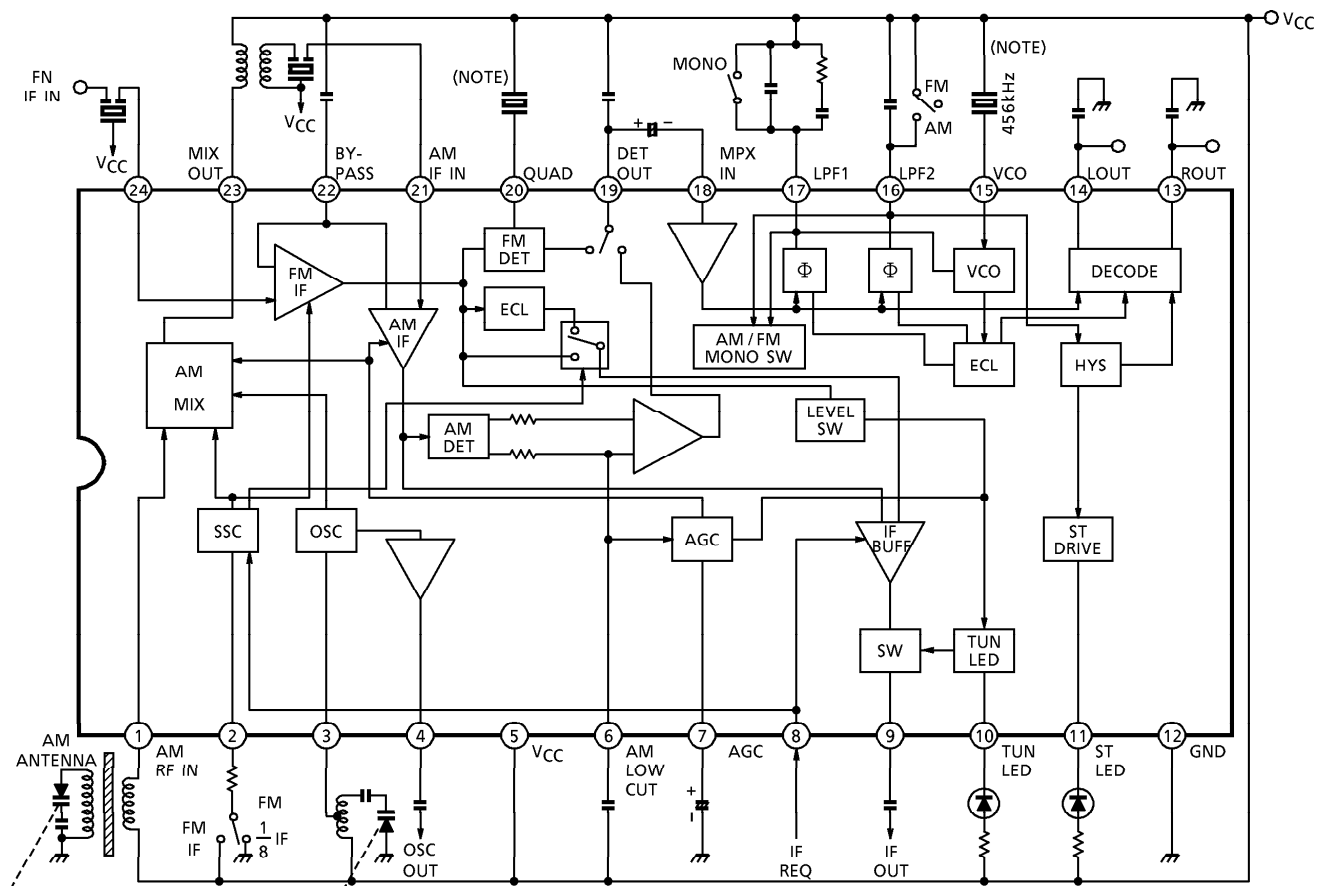

(NOTE)

We recommend

Ceramic resonator : CSB456F18

Ceramic discriminator : CDA10.7MG18 (MURATA MFG CO., LTD)

EXPLANATION OF TERMINALS

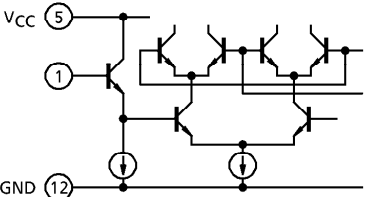
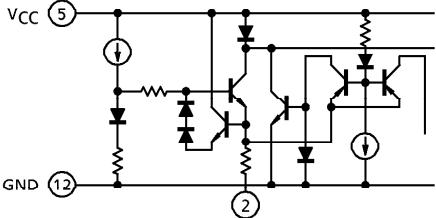
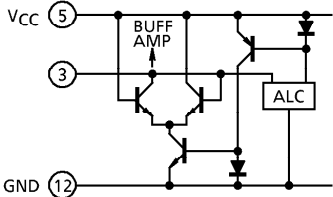
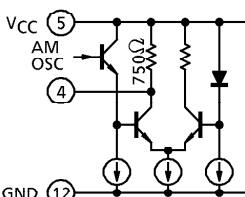
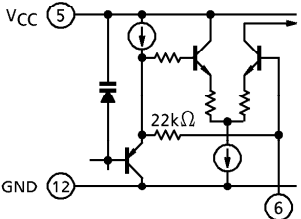
PIN No.	ITEM	INTERNAL CIRCUIT	DC VOLTAGE (V) (at no signal)	
			AM	FM
1	AM RF IN		3.0	3.0
2	<ul style="list-style-type: none"> • IF Count Output Sensitivity Adjust Terminal • FM IF Divider Control Terminal 		—	—
3	AM OSC		3.0	3.0
4	AM OSC OUT		2.7	3.0
5	V _{CC}	—	3.0	3.0
6	AM LOW CUT		2.3	2.3

PIN No.	ITEM	INTERNAL CIRCUIT	DC VOLTAGE (V) (at no signal)	
			AM	FM
7	AGC		0.25	0.35
8	IF OUT SW		—	—
9	IF OUT		3.0	3.0
10	TUN LED (Tuning LED)		—	—
11	ST LED (Stereo LED)		—	—
12	GND	—	0	0
13 14	R-OUT L-OUT		1.0	1.0

PIN No.	ITEM	INTERNAL CIRCUIT	DC VOLTAGE (V) (at no signal)	
			AM	FM
15	VCO		2.5	2.5 (VCO Stop mode)
16	LPF2 ● LPF Terminal for Synchronous Detector ● Bias Terminal for AM/FM Switch Circuit $V_{16} = V_{CC} \rightarrow \text{AM}$ $V_{16} = \text{open} \rightarrow \text{FM}$		3.0	2.2
17	LPF1 ● LPF Terminal for Phase Detector ● VCO Stop Terminal $V_{17} = V_{CC} \rightarrow \text{VCO Stop}$		2.7	2.2
18	MPX IN		0.7	0.7
19	DET OUT		1.1	1.1

PIN No.	ITEM	INTERNAL CIRCUIT	DC VOLTAGE (V) (at no signal)	
			AM	FM
20	QUAD (FM QUAD. Detector)		2.4	2.1
21	AM IF IN		3.0	3.0
22	BY-PASS (AM IF AMP BY-PASS FM IF AMP BY-PASS)		2.3	2.8
23	AM MIX OUT		3.0	3.0
24	FM IF IN		3.0	3.0

APPLICATION NOTE

1. How to control the IF Count Output Signal (pin⑨ output)

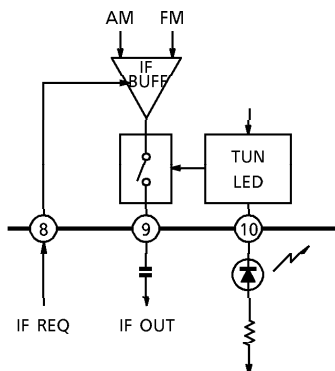

		TUN LED	
		ON	OFF
V ₈	H	Come out	Non output
	L	Non output	Non output

- Whether or not there is the IF Count output signal (pin⑨ output) is determined by the AND of the pin⑧ control voltage : V_g and tuning LED on/off switching.
In the condition of
 V_g : High (Active High, V_{TH} = 0.8V (Typ.))
 TUN LED : ON (V_{in} ≥ V_L + 2dBμV EMF (Typ.))
 the IF count output signal comes out from the pin⑨.
 In the case of the Tuning LED function is not needed, it doesn't matter the pin⑩ is opened.
- The output impedance of pin⑨ is 1.5kΩ (Typ.) (cf. P.4)
It is possible to reduce the IF count output signal level to add the resistance between the pin⑨ and the V_{CC} line.
- The signal waveform is the rectangular wave, and the level is 500mV_{p-p} (Typ.)

2. How to control the Divider of FM IF

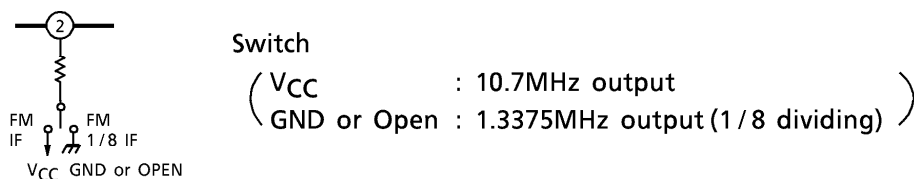

3. How to adjust the IF Count Output Sensitivity

- The IF Count Output Sensitivity (Search sensitivity)
Can be adjusted by varying the IF AMP gain for FM and varying the Mixer gain for AM. This setting is made by changing the value of external resistance R₂ which is connected to pin②.
- However, this is only possible at the Auto-Tuning Mode. (external voltage supplied to pin⑧ is at High level.) The original again returns while receiving a broadcast station (supplied voltage to pin⑧ is at Low level.)

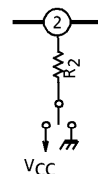

○ The Gain Loss of FM IF AMP

		R ₂	
		0Ω	10kΩ (Note)
MODE	IF (10.7MHz)	-20dB	-1dB
	1/8 IF (1.3375MHz)	-20dB	-1dB

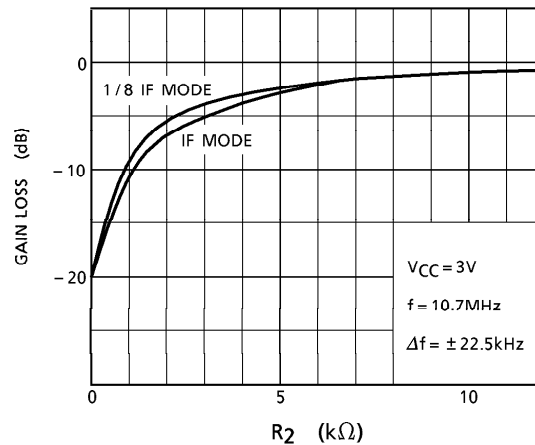

(Note)

- In the condition of the 1/8 IF Mode, it is possible to set up R₂ = ∞ (open).
- In the condition of IF Mode, it is necessary to set up the value of R₂ under 10kΩ. When the R₂ is over 10kΩ it is feared that the Mode is change to the 1/8 IF Mode.

○ The Gain Loss of AM Mixer

R ₂	
0Ω	10kΩ
-16dB	-1dB

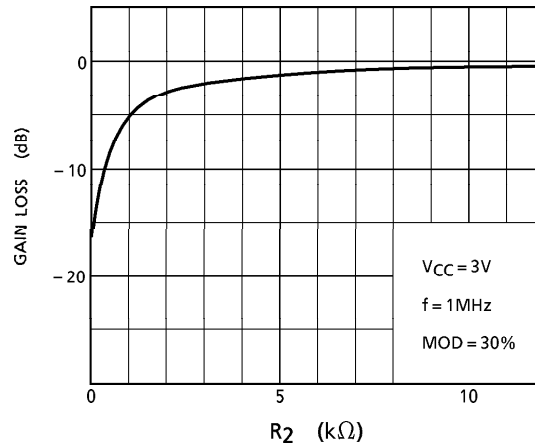

4. AM Low-Cut Circuit

- The AM Low-Cut action is carried out by the bypass of the high frequency component of the positive-feedback signal at the AF AMP stage. The external capacitor : C₆ by-passes this component.
- The cut-off frequency f_L is determine by the internal resistance 22kΩ (Typ.) and the external capacitor C₆ as following ;

$$f_L = \frac{1}{2 \times \pi \times 22 \times 10^3 \times C_6} \text{ (Hz)}$$

- In the case of the AM Low-Cut function is not needed, set up the value of C₆ over 0.47μF. In the condition of C₆ ≥ 0.47μF, the frequency characteristic has flat response at the low frequency.

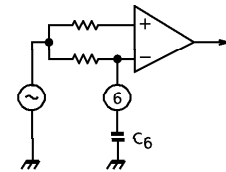

5. AM Local Oscillator Buffer Output

- The output impedance of AM Local Oscillator Buffer Output pin (Pin④) is 750Ω (Typ.) (cf. P.3)
- It is possible to reduce the output level to add the resistance between the pin④ and V_{CC} line. The signal waveform is the rectangular wave, and the level is $500mV_{p-p}$ ($f_{OSC} = 1.45MHz$, Typ.)
- The higher local oscillation frequency (f_{OSC}) to be, the lower buff output level to be owing to the load capacity. So, in the case that it is connected to other circuits, take care of the input capacity of these circuits and stray capacity of wire.

6. Tuning LED Driver and Stereo LED Driver

- The Tuning LED Driver and Stereo LED Driver don't have current limit resistance shown in the right figure. So, it is necessary to add the current limit resistance : R_{10} , R_{11} .
- Set up the values of R_{10} , R_{11} to keep the drive currents ID_{10} , ID_{11} under 10mA.

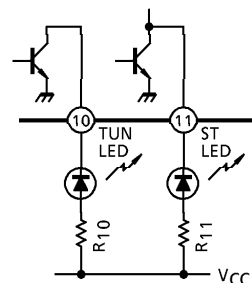

7. FM Detection Circuit

For the FM detection circuit, detection coil is able to use instead of ceramic discriminator. Recommended circuit and recommended coil are as follows. In this case, please take care that $V_{in}(lim.)$ falls a little.

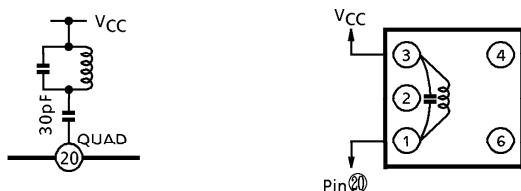

TEST FREQUENCY	C_o (pF)	Q_o	TURNS				WIRE (mm ϕ)	REF
			1-2	2-3	1-3	4-6		
10.7MHz	100	100	—	—	12	—	0.12 UEW	SUMIDA ELECTRIC CO., LTD 2153-4095-189 or Equivalent

8. FM / AM Switch and Forced Monaural Switch

FM / AM switch over and stere / forced monaural switch over are done by internal PNP transistors ON / OFF which are connected to pin¹⁶ and pin¹⁷ respectively.

The threshold voltages of these PNP transistors are $V_{th} = V_{CC}$, and for switching, we recommend to use mechanical switch. (Direct short to V_{CC} line.)

In the case of the electrical switch over by transistor, set up V_{CE} (saturation voltage between collector and emitter) 50mV or less, otherwise there are some cases that it does not become the AM mode and force monaural mode.

When these external switches are ON, the currents which flow into pin¹⁶ and pin¹⁷ are $100\mu A$ and $20\mu A$ respectively. (Typical value at $V_{CC} = 3V$)

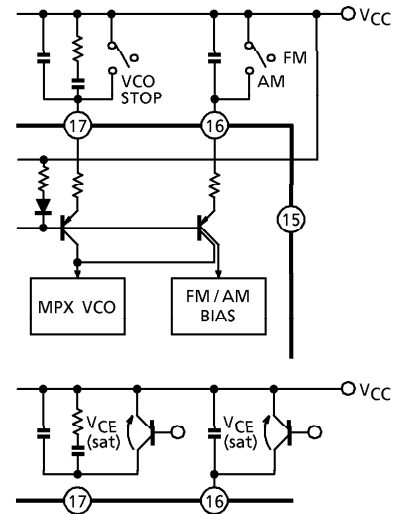

MAXIMUM RATINGS ($T_a = 25^\circ C$)

CHARACTERISTIC	SYMBOL	RATING	UNIT
Supply Voltage	V_{CC}	8	V
LED Current	I_{LED}	10	mA
LED Voltage	V_{LED}	8	V
Power Dissipation	TA8132AN	P_D (Note)	mW
	TA8132AF		
		400	
Operating Temperature	T_{opr}	- 25~75	$^\circ C$
Storage Temperature	T_{stg}	- 55~150	$^\circ C$

Note : Derated above $25^\circ C$ in the proportion of $9.6mW/^\circ C$ for TA8132AN and of $3.2mW/^\circ C$ for TA8132AF.

ELECTRICAL CHARACTERISTICS

Unless otherwise specified, $T_a = 25^\circ\text{C}$, $V_{CC1} = 3\text{V}$, $SW_1 \rightarrow 10\text{k}\Omega$, $SW_3 \rightarrow \text{OFF}$
 FM IF : $f = 10.7\text{MHz}$, $\Delta f = \pm 22.5\text{kHz}$, $f_m = 1\text{kHz}$
 AM : $f = 1\text{MHz}$, $\text{MOD} = 30\%$, $f_m = 1\text{kHz}$
 MPX : $f_m = 1\text{kHz}$

CHARACTERISTIC		SYMBOL	TEST CIRCUIT	TEST CONDITION	MIN.	TYP.	MAX.	UNIT	
Supply Current		$I_{CC}(\text{FM})$	1	FM Mode, $V_{in} = 0$	—	11.0	14.0	mA	
		$I_{CC}(\text{AM})$	1	AM Mode, $V_{in} = 0$	—	10.5	13.5		
FM IF	Input Limiting Voltage	$V_{in}(\text{lim.})$	1	-3dB Limiting Point	41	46	51	$\text{dB}\mu\text{V EMF}$	
	Recovered Output Voltage	V_{OD}	1	$V_{in} = 80\text{dB}\mu\text{V EMF}$	50	75	100	mV_{rms}	
	Signal to Noise Ratio	S/N	1	$V_{in} = 80\text{dB}\mu\text{V EMF}$	—	65	—	dB	
	Total Harmonic Distortion	THD	1	$V_{in} = 80\text{dB}\mu\text{V EMF}$	—	0.2	—	%	
	AM Rejection Ratio	AMR	1	$V_{in} = 80\text{dB}\mu\text{V EMF}$	—	38	—	dB	
	LED ON Sensitivity	V_L	1	$I_L = 1\text{mA}$	48	53	58	$\text{dB}\mu\text{V EMF}$	
	IF Count Output Frequency	IF	$f_{IF}(\text{FM})$	1	$V_{in} = 80\text{dB}\mu\text{V EMF}$, $SW_2 \rightarrow V_{CC}$, $SW_3 \rightarrow \text{ON}$	—	10.7	—	MHz
		1/8 IF	$f_{1/8 IF}(\text{FM})$	1	$V_{in} = 80\text{dB}\mu\text{V EMF}$, $SW_2 \rightarrow \text{GND}$, $SW_3 \rightarrow \text{ON}$	1.3374	1.3375	1.3376	
	IF Count Output Voltage	IF	$V_{IF}(\text{FM})$	1	$V_{in} = 61\text{dB}\mu\text{V EMF}$, $SW_2 \rightarrow V_{CC}$, $SW_3 \rightarrow \text{ON}$	350	500	—	$\text{mV}_{\text{p-p}}$
		1/8 IF	$V_{1/8 IF}(\text{FM})$	1	$V_{in} = 61\text{dB}\mu\text{V EMF}$, $SW_2 \rightarrow \text{GND}$, $SW_3 \rightarrow \text{ON}$	350	500	—	
IF Count Output Sensitivity		$IF_{\text{sens.}}(\text{FM})$	1	$SW_1 \rightarrow 0$, $SW_2 \rightarrow \text{GND}$, $SW_3 \rightarrow \text{ON}$	—	76	—	$\text{dB}\mu\text{V EMF}$	
				$SW_1 \rightarrow 510\Omega$, $SW_2 \rightarrow \text{GND}$, $SW_3 \rightarrow \text{ON}$	—	68	—		
				$SW_1 \rightarrow 0$, $SW_2 \rightarrow V_{CC}$, $SW_3 \rightarrow \text{ON}$	—	77	—		
				$SW_1 \rightarrow 510\Omega$, $SW_2 \rightarrow V_{CC}$, $SW_3 \rightarrow \text{ON}$	—	69	—		

CHARACTERISTIC		SYMBOL	TEST CIRCUIT	TEST CONDITION	MIN.	TYP.	MAX.	UNIT
AM	Gain	G_V	1	$V_{in} = 26\text{dB}\mu\text{V}$ EMF	28	57	85	mV _{rms}
	Recovered Output Voltage	V_{OD}	1	$V_{in} = 60\text{dB}\mu\text{V}$ EMF	50	75	100	
	Signal to Noise Ratio	S/N	1	$V_{in} = 60\text{dB}\mu\text{V}$ EMF	—	41	—	dB
	Total Harmonic Distortion	THD	1	$V_{in} = 60\text{dB}\mu\text{V}$ EMF	—	1.0	—	%
	LED ON Sensitivity	V_L	1	$I_L = 1\text{mA}$	21	26	31	dB μV EMF
	Local OSC Buff. Output Voltage	V_{OSC} (AM)	1	$f_{OSC} = 1.45\text{MHz}$	350	500	—	mV _{p-p}
			2	$f_{OSC} = 27\text{MHz}$	—	500	—	
	IF Count Output Voltage	V_{IF} (AM)	1	$V_{in} = 39\text{dB}\mu\text{V}$ EMF, $SW_3 \rightarrow \text{ON}$	350	500	—	mV _{p-p}
IF Count Output Sensitivity	$I_{Fsens.}$ (AM)	1	$SW_1 \rightarrow 0, SW_2 \rightarrow \text{GND}, SW_3 \rightarrow \text{ON}$	—	49	—	dB μV EMF	
			$SW_1 \rightarrow 510\Omega, SW_2 \rightarrow \text{GND}, SW_3 \rightarrow \text{ON}$	—	42	—		
			$SW_1 \rightarrow 0, SW_2 \rightarrow V_{CC}, SW_3 \rightarrow \text{ON}$	—	49	—		
			$SW_1 \rightarrow 510\Omega, SW_2 \rightarrow V_{CC}, SW_3 \rightarrow \text{ON}$	—	42	—		
Pin ¹⁹ Output Resistance	R_{19}	1	FM Mode	—	0.6	—	k Ω	
			AM Mode	—	12	—		

CHARACTERISTIC		SYMBOL	TEST CIRCUIT	TEST CONDITION	MIN.	TYP.	MAX.	UNIT	
MPX	Input Resistance	R_{IN}	1	—	—	25	—	$k\Omega$	
	Output Resistance	R_{OUT}	1	—	—	5	—		
	Max. Composite Signal Input Voltage		$V_{in\ MAX}$ (Stereo)	1	L + R = 90%, P = 10% THD = 3%, SWg → LPF : ON	—	350	—	mV_{rms}
	Separation		Sep	—	L + R = 135 mV_{rms} , P = 15 mV_{rms} , SWg → LPF : ON	$f_m = 100Hz$ — $f_m = 1kHz$ — $f_m = 10kHz$	42 35 42 42	— — — —	dB
	Total Harmonic Distortion	Monaural	THD (Monaural)	1	$V_{in} = 150mV_{rms}$ (MONO)	—	0.2	—	
		Stereo	THD (Stereo)						
	Voltage Gain		G_V (MPX)	1	$V_{in} = 150mV_{rms}$ (MONO)	-5	-3	-1	dB
	Channel Balance		C.B.	1	$V_{in} = 150mV_{rms}$ (MONO)	-2	0	2	dB
	Stereo LED Sensitivity	ON	V_L (ON)	1	Pilot Input	—	8	15	mV_{rms}
		OFF	V_L (OFF)			2	6	—	
	Stereo LED Hysteresis		V_H	1	To LED turn off from LED turn on	—	2	—	mV_{rms}
	Capture Range		C.R.	1	P = 15 mV_{rms}	—	± 1.3	—	%
Signal to Noise Ratio		S/N	1	$V_{in} = 150mV_{rms}$ (MONO)	—	78	—	dB	

TEST CIRCUIT 1

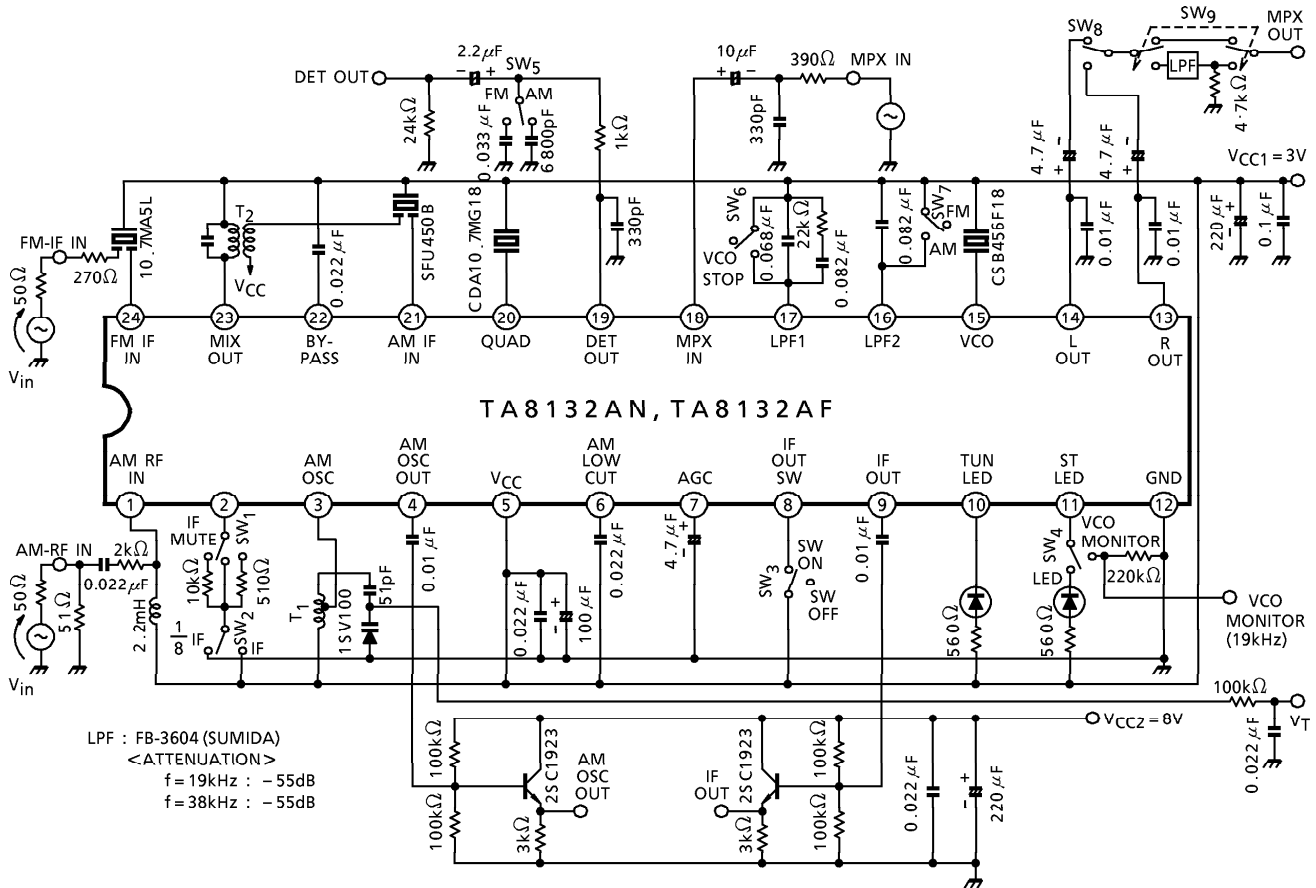

COIL DATA (TEST CIRCUIT 1)

COIL No.	f	L (μ H)	C ₀ (pF)	Q ₀	TURN				WIRE (mm)	RED. (COIL No.)
					1-2	2-3	1-3	4-6		
T ₁ AM OSC	796kHz	288	—	115	13	73	—	—	0.08 UEW	4147-1356-038 (S)
T ₂ AM IFT	455kHz	—	180	120	—	—	180	15	0.06 UEW	2150-2162-165 (S)

(S) : SUMIDA ELECTRIC Co., Ltd.

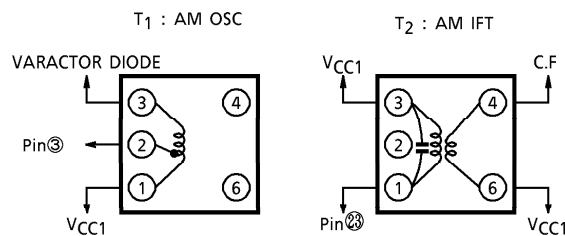

TEST CIRCUIT 2

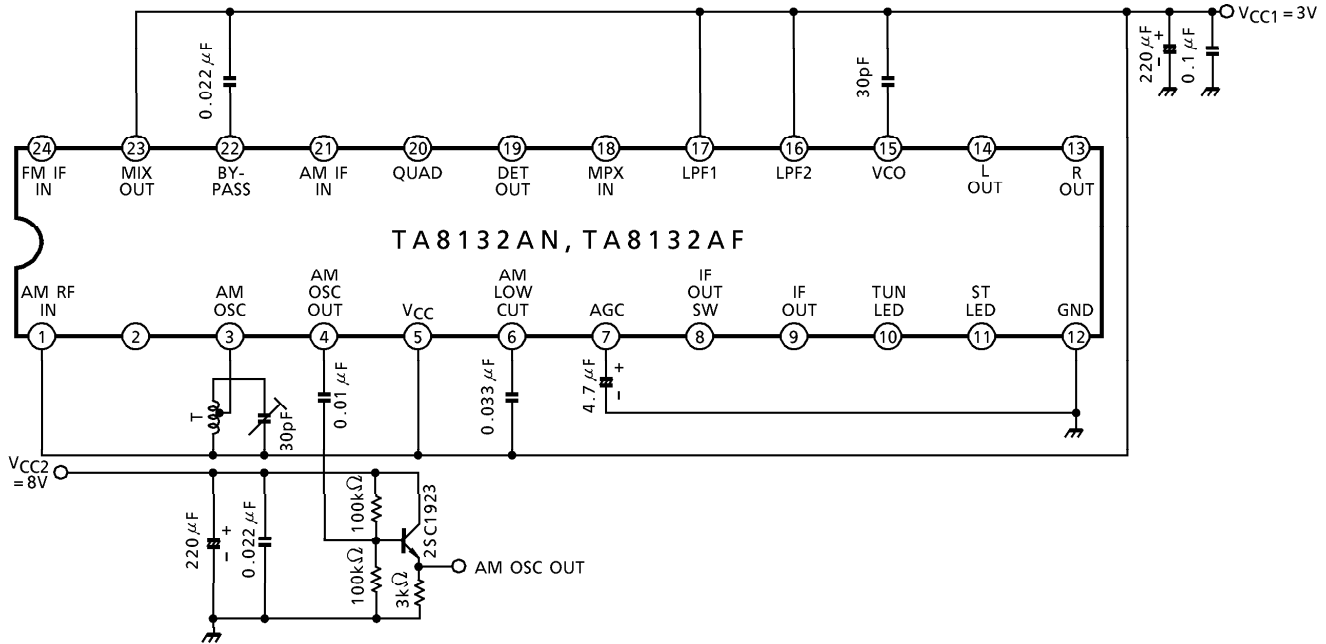

COIL DATA (TEST CIRCUIT 2)

COIL No.	f	L (μ H)	C_o (pF)	Q_o	TURN				WIRE (mm)	REF. (COIL No.)
					1-2	2-3	1-3	4-6		
T AM OSC	7.96MHz	1.4	—	84	1	6	7	—	0.08 UEW	Ⓣ 7PL-1344Y

Ⓣ : TOKO Co., Ltd.

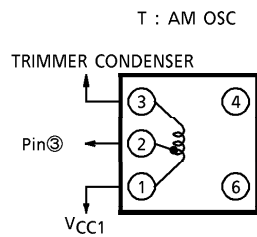

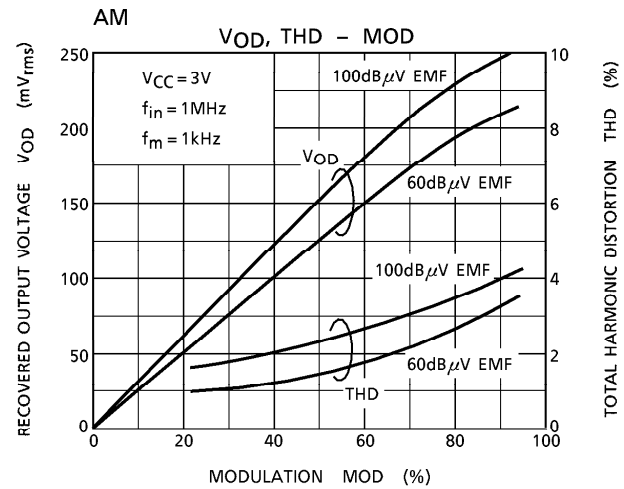
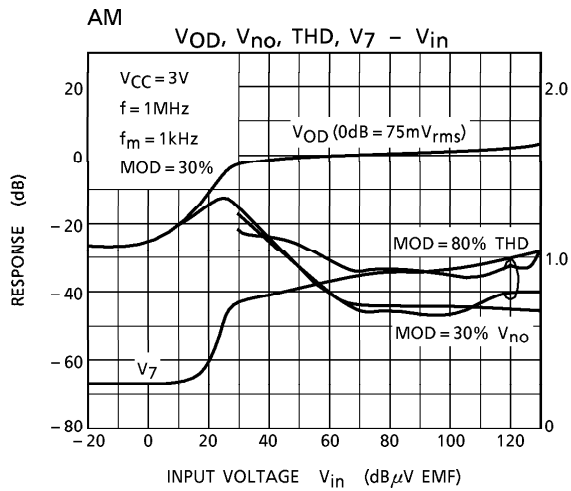
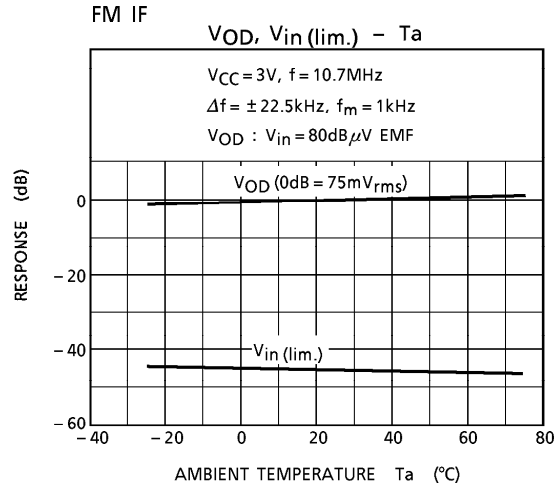
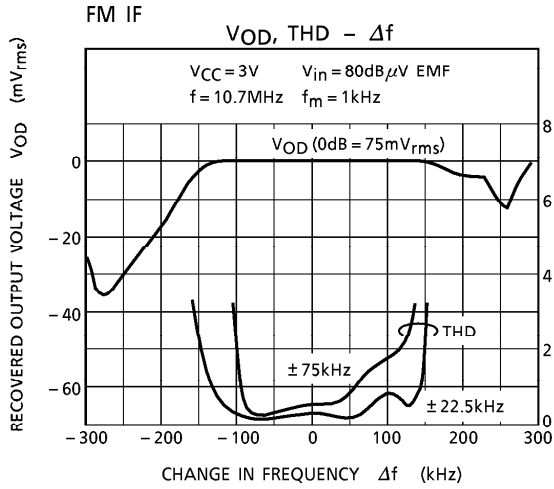
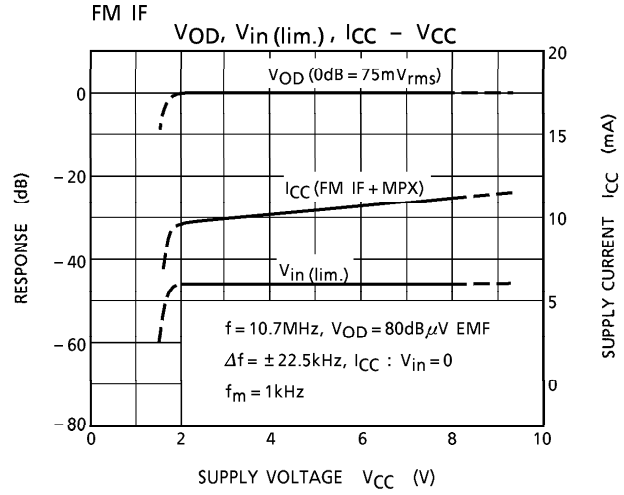
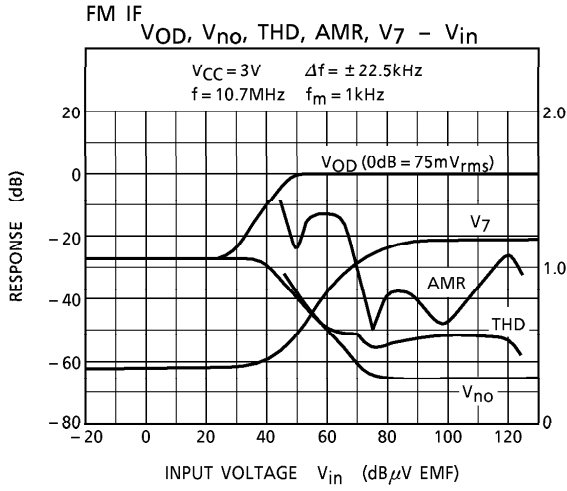

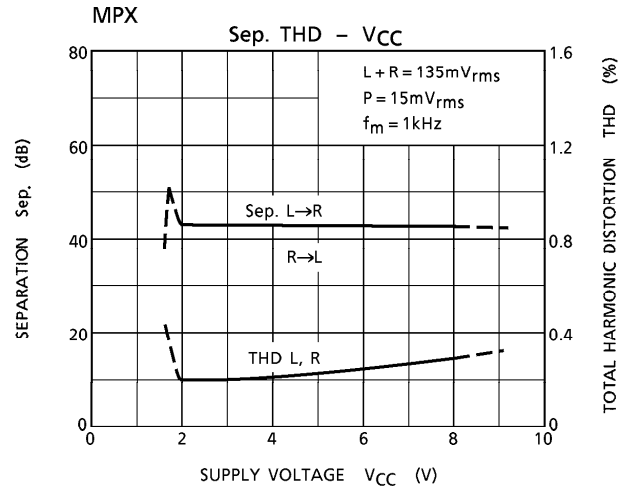
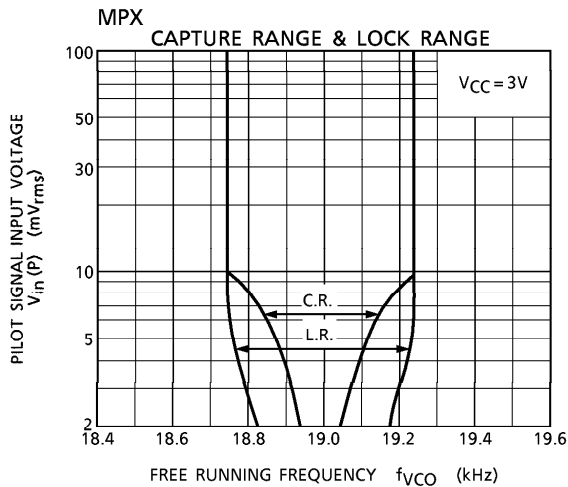
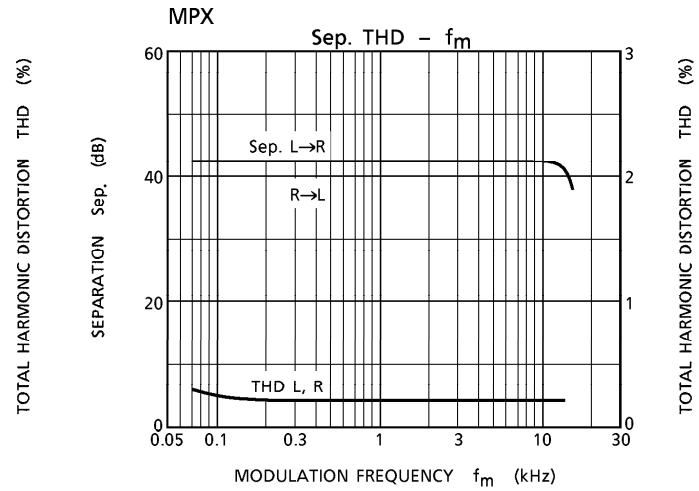
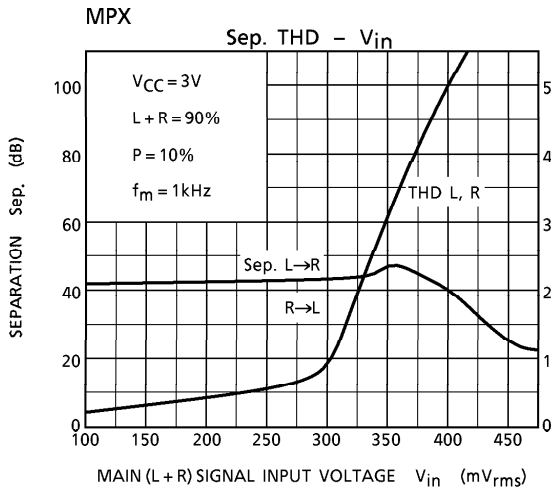
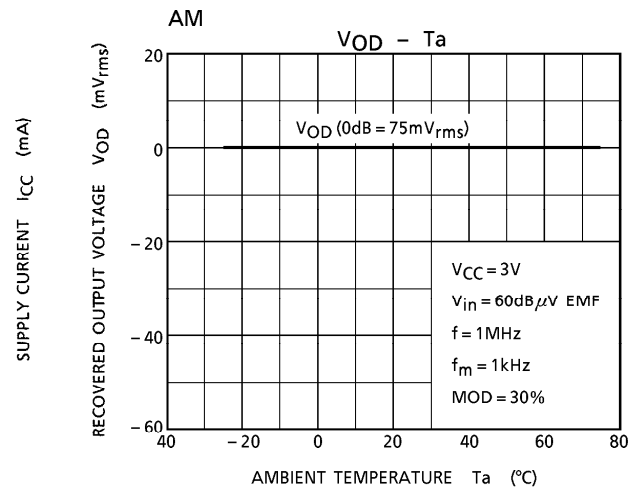
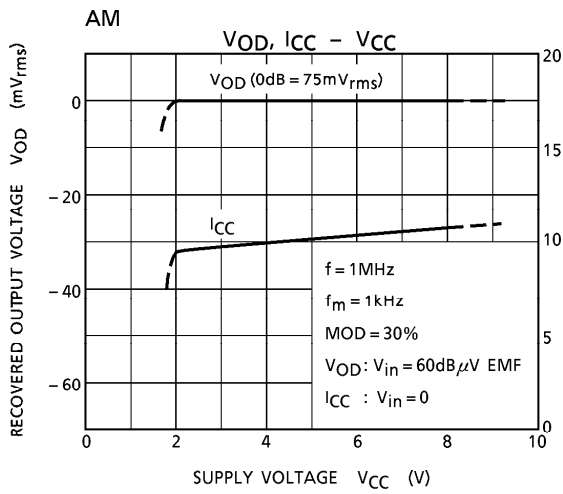

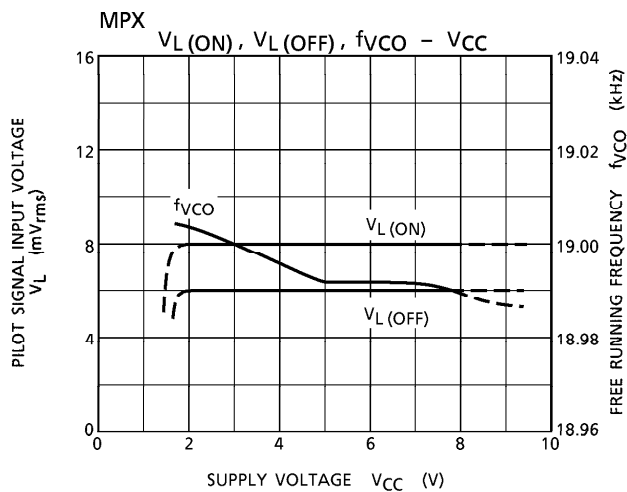
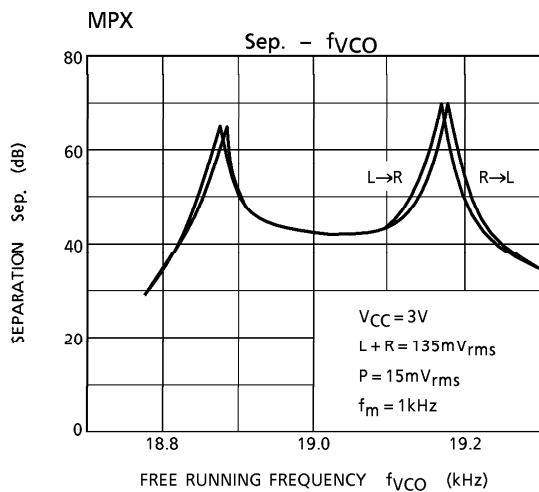

OUTLINE DRAWING
SDIP24-P-300

Unit : mm

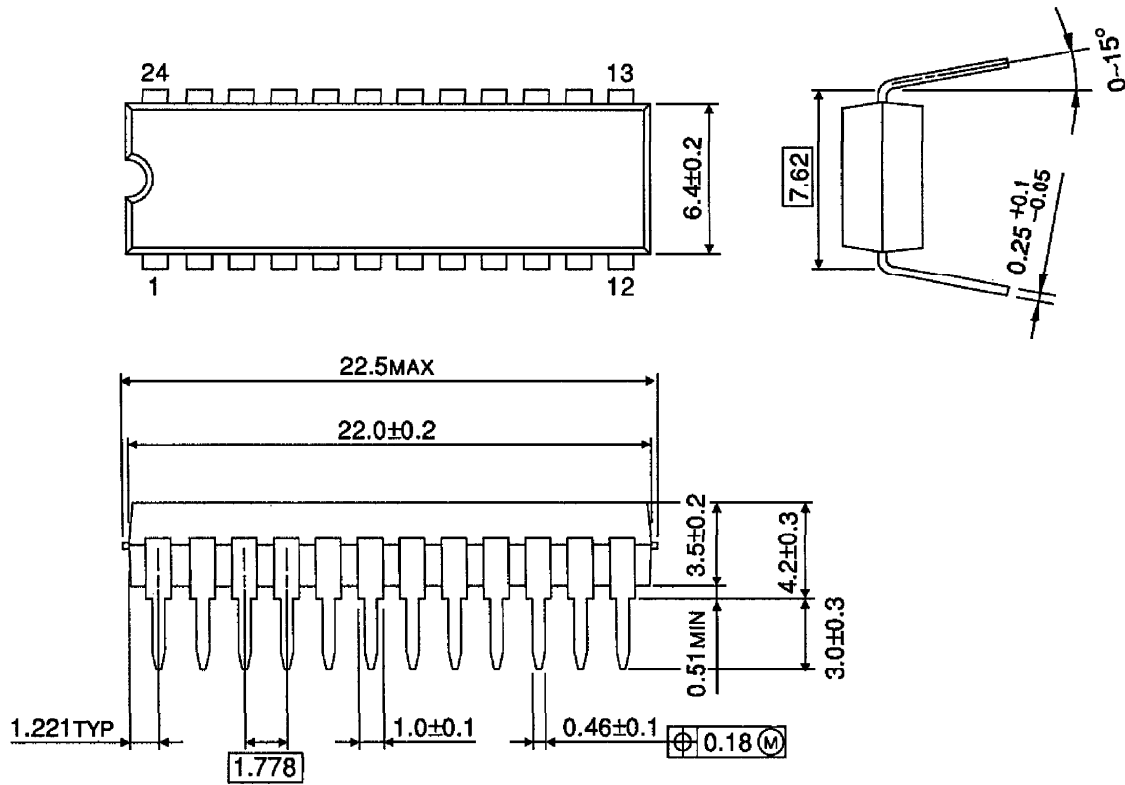

Weight : 1.2g (Typ.)

OUTLINE DRAWING
SSOP24-P-300

Unit : mm

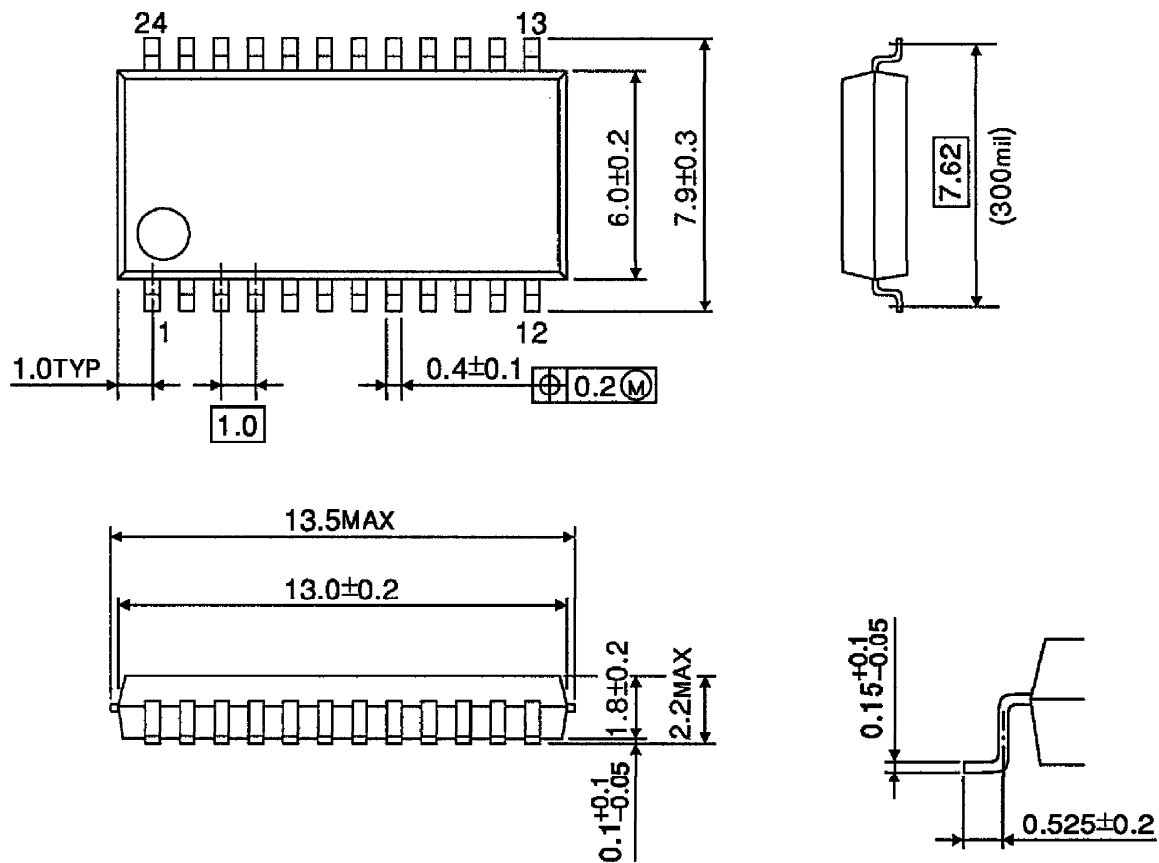

Weight : 0.31g (Typ.)

TA8132AN - 20*
1994 - 3 - 8
TOSHIBA CORPORATION