

LM78LXX Series 3-Terminal Positive Regulators

General Description

The LM78LXX series of three terminal positive regulators is available with several fixed output voltages making them useful in a wide range of applications. When used as a zener diode/resistor combination replacement, the LM78LXX usually results in an effective output impedance improvement of two orders of magnitude, and lower quiescent current. These regulators can provide local on card regulation, eliminating the distribution problems associated with single point regulation. The voltages available allow the LM78LXX to be used in logic systems, instrumentation, HiFi, and other solid state electronic equipment.

The LM78LXX is available in the metal three-lead TO-39(H) package, the plastic TO-92 (Z) package, and the plastic SO-8 (M) package. With adequate heat sinking the regulator can deliver 100 mA output current. Current limiting is included to limit the peak output current to a safe value. Safe area protection for the output transistors is provided to limit internal power dissipation. If internal power dissipation becomes too high for the heat sinking provided, the thermal shutdown circuit takes over preventing the IC from overheating.

Features

- Output voltage tolerances of $\pm 5\%$ (LM78LXXAC) over the temperature range
- Output current of 100 mA
- Internal thermal overload protection
- Output transistor safe area protection
- Internal short circuit current limit
- Available in plastic TO-92 and metal TO-39 and plastic SO-8 low profile packages
- No external components
- Output voltages of 5.0V, 6.2V, 8.2V, 9.0V, 12V, 15V

Connection Diagrams

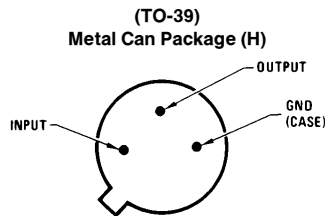

Bottom View

**Order Number LM78L05ACH,
LM78L12ACH or LM78L15ACH
See NS Package Number H03A**

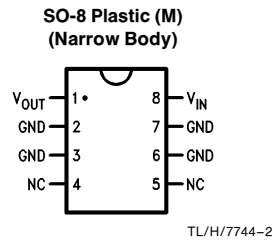

Top View

**Order Number LM78L05ACM,
LM78L12ACM or LM78L15ACM
See NS Package Number M08A**

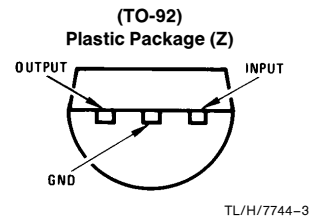

Bottom View

**Order Number
LM78L05ACZ, LM78L09ACZ,
LM78L12ACZ, LM78L15ACZ,
LM78L62ACZ or LM78L82ACZ
See NS Package Number Z03A**

Absolute Maximum Ratings (Note 1)

If Military/Aerospace specified devices are required, please contact the National Semiconductor Sales Office/Distributors for availability and specifications.

Power Dissipation (Note 5) Internally Limited
Input Voltage 35V

Storage Temperature -65°C to +150°C
Operating Junction Temperature 0°C to +125°C
Lead Temperature (Soldering, 10 seconds) 265°C
ESD Susceptibility (Note 2) 2 kV

LM78LXXAC Electrical Characteristics

Limits in standard typeface are for $T_J = 25^\circ\text{C}$, **bold typeface applies over the 0°C to $+125^\circ\text{C}$ temperature range.** Limits are guaranteed by production testing or correlation techniques using standard Statistical Quality Control (SQC) methods. Unless otherwise specified: $I_O = 40\text{ mA}$, $C_I = 0.33\ \mu\text{F}$, $C_O = 0.1\ \mu\text{F}$.

LM78L05AC Unless otherwise specified, $V_{IN} = 10\text{V}$

Symbol	Parameter	Conditions	Min	Typ	Max	Units
V_O	Output Voltage		4.8	5	5.2	V
		$7\text{V} \leq V_{IN} \leq 20\text{V}$ $1\text{ mA} \leq I_O \leq 40\text{ mA}$ (Note 3)	4.75		5.25	
		$1\text{ mA} \leq I_O \leq 70\text{ mA}$ (Note 3)	4.75		5.25	
ΔV_O	Line Regulation	$7\text{V} \leq V_{IN} \leq 20\text{V}$		18	75	mV
		$8\text{V} \leq V_{IN} \leq 20\text{V}$		10	54	
ΔV_O	Load Regulation	$1\text{ mA} \leq I_O \leq 100\text{ mA}$		20	60	
		$1\text{ mA} \leq I_O \leq 40\text{ mA}$		5	30	
I_Q	Quiescent Current			3	5	mA
ΔI_Q	Quiescent Current Change	$8\text{V} \leq V_{IN} \leq 20\text{V}$			1.0	
		$1\text{ mA} \leq I_O \leq 40\text{ mA}$			0.1	
V_n	Output Noise Voltage	$f = 10\text{ Hz to }100\text{ kHz}$ (Note 4)		40		μV
$\frac{\Delta V_{IN}}{\Delta V_{OUT}}$	Ripple Rejection	$f = 120\text{ Hz}$ $8\text{V} \leq V_{IN} \leq 16\text{V}$	47	62		dB
I_{PK}	Peak Output Current			140		mA
$\frac{\Delta V_O}{\Delta T}$	Average Output Voltage Tempco	$I_O = 5\text{ mA}$		-0.65		mV/°C
V_{IN} (Min)	Minimum Value of Input Voltage Required to Maintain Line Regulation			6.7	7	V

LM78LXXAC Electrical Characteristics

Limits in standard typeface are for $T_J = 25^\circ\text{C}$, **bold typeface applies over the 0°C to $+125^\circ\text{C}$ temperature range**. Limits are guaranteed by production testing or correlation techniques using standard Statistical Quality Control (SQC) methods. Unless otherwise specified: $I_O = 40\text{ mA}$, $C_I = 0.33\ \mu\text{F}$, $C_O = 0.1\ \mu\text{F}$. (Continued)

LM78L62AC Unless otherwise specified, $V_{IN} = 12\text{V}$

Symbol	Parameter	Conditions	Min	Typ	Max	Units
V_O	Output Voltage		5.95	6.2	6.45	V
		$8.5\text{V} \leq V_{IN} \leq 20\text{V}$ $1\text{ mA} \leq I_O \leq 40\text{ mA}$ (Note 3)	5.9		6.5	
		$1\text{ mA} \leq I_O \leq 70\text{ mA}$ (Note 3)	5.9		6.5	
ΔV_O	Line Regulation	$8.5\text{V} \leq V_{IN} \leq 20\text{V}$		65	175	mV
		$9\text{V} \leq V_{IN} \leq 20\text{V}$		55	125	
ΔV_O	Load Regulation	$1\text{ mA} \leq I_O \leq 100\text{ mA}$		13	80	mV
		$1\text{ mA} \leq I_O \leq 40\text{ mA}$		6	40	
I_Q	Quiescent Current			2	5.5	mA
ΔI_Q	Quiescent Current Change	$8\text{V} \leq V_{IN} \leq 20\text{V}$			1.5	
		$1\text{ mA} \leq I_O \leq 40\text{ mA}$			0.1	
V_n	Output Noise Voltage	$f = 10\text{ Hz to }100\text{ kHz}$ (Note 4)		50		μV
$\frac{\Delta V_{IN}}{\Delta V_{OUT}}$	Ripple Rejection	$f = 120\text{ Hz}$ $10\text{V} \leq V_{IN} \leq 20\text{V}$	40	46		dB
I_{PK}	Peak Output Current			140		mA
$\frac{\Delta V_O}{\Delta T}$	Average Output Voltage Tempco	$I_O = 5\text{ mA}$		-0.75		$\text{mV}/^\circ\text{C}$
V_{IN} (Min)	Minimum Value of Input Voltage Required to Maintain Line Regulation			7.9		V

LM78LXXAC Electrical Characteristics

Limits in standard typeface are for $T_J = 25^\circ\text{C}$, **bold typeface applies over the 0°C to $+125^\circ\text{C}$ temperature range.** Limits are guaranteed by production testing or correlation techniques using standard Statistical Quality Control (SQC) methods. Unless otherwise specified: $I_O = 40\text{ mA}$, $C_I = 0.33\ \mu\text{F}$, $C_O = 0.1\ \mu\text{F}$. (Continued)

LM78L82AC Unless otherwise specified, $V_{IN} = 14\text{V}$

Symbol	Parameter	Conditions	Min	Typ	Max	Units
V_O	Output Voltage		7.87	8.2	8.53	V
		$11\text{V} \leq V_{IN} \leq 23\text{V}$ $1\text{ mA} \leq I_O \leq 40\text{ mA}$ (Note 3)	7.8		8.6	
		$1\text{ mA} \leq I_O \leq 70\text{ mA}$ (Note 3)	7.8		8.6	
ΔV_O	Line Regulation	$11\text{V} \leq V_{IN} \leq 23\text{V}$		80	175	mV
		$12\text{V} \leq V_{IN} \leq 23\text{V}$		70	125	
ΔV_O	Load Regulation	$1\text{ mA} \leq I_O \leq 100\text{ mA}$		15	80	mV
		$1\text{ mA} \leq I_O \leq 40\text{ mA}$		8	40	
I_Q	Quiescent Current			2	5.5	mA
ΔI_Q	Quiescent Current Change	$12\text{V} \leq V_{IN} \leq 23\text{V}$			1.5	
		$1\text{ mA} \leq I_O \leq 40\text{ mA}$			0.1	
V_n	Output Noise Voltage	$f = 10\text{ Hz to }100\text{ kHz}$ (Note 4)		60		μV
$\frac{\Delta V_{IN}}{\Delta V_{OUT}}$	Ripple Rejection	$f = 120\text{ Hz}$ $12\text{V} \leq V_{IN} \leq 22\text{V}$	39	45		dB
I_{PK}	Peak Output Current			140		mA
$\frac{\Delta V_O}{\Delta T}$	Average Output Voltage Tempco	$I_O = 5\text{ mA}$		-0.8		mV/ $^\circ\text{C}$
V_{IN} (Min)	Minimum Value of Input Voltage Required to Maintain Line Regulation			9.9		V

LM78LXXAC Electrical Characteristics

Limits in standard typeface are for $T_J = 25^\circ\text{C}$, **bold typeface applies over the 0°C to $+125^\circ\text{C}$ temperature range**. Limits are guaranteed by production testing or correlation techniques using standard Statistical Quality Control (SQC) methods. Unless otherwise specified: $I_O = 40\text{ mA}$, $C_I = 0.33\ \mu\text{F}$, $C_O = 0.1\ \mu\text{F}$. (Continued)

LM78L09AC Unless otherwise specified, $V_{IN} = 15\text{V}$

Symbol	Parameter	Conditions	Min	Typ	Max	Units
V_O	Output Voltage		8.64	9.0	9.36	V
		$11.5\text{V} \leq V_{IN} \leq 24\text{V}$ $1\text{ mA} \leq I_O \leq 40\text{ mA}$ (Note 3)	8.55		9.45	
		$1\text{ mA} \leq I_O \leq 70\text{ mA}$ (Note 3)	8.55		9.45	
ΔV_O	Line Regulation	$11.5\text{V} \leq V_{IN} \leq 24\text{V}$		100	200	mV
		$13\text{V} \leq V_{IN} \leq 24\text{V}$		90	150	
ΔV_O	Load Regulation	$1\text{ mA} \leq I_O \leq 100\text{ mA}$		20	90	mV
		$1\text{ mA} \leq I_O \leq 40\text{ mA}$		10	45	
I_Q	Quiescent Current			2	5.5	mA
ΔI_Q	Quiescent Current Change	$11.5\text{V} \leq V_{IN} \leq 24\text{V}$			1.5	
		$1\text{ mA} \leq I_O \leq 40\text{ mA}$			0.1	
V_n	Output Noise Voltage			70		μV
$\frac{\Delta V_{IN}}{\Delta V_{OUT}}$	Ripple Rejection	$f = 120\text{ Hz}$ $15\text{V} \leq V_{IN} \leq 25\text{V}$	38	44		dB
I_{PK}	Peak Output Current			140		mA
$\frac{\Delta V_O}{\Delta T}$	Average Output Voltage Tempco	$I_O = 5\text{ mA}$		-0.9		$\text{mV}/^\circ\text{C}$
V_{IN} (Min)	Minimum Value of Input Voltage Required to Maintain Line Regulation			10.7		V

LM78LXXAC Electrical Characteristics

Limits in standard typeface are for $T_J = 25^\circ\text{C}$, **bold typeface applies over the 0°C to $+125^\circ\text{C}$ temperature range.** Limits are guaranteed by production testing or correlation techniques using standard Statistical Quality Control (SQC) methods. Unless otherwise specified: $I_O = 40\text{ mA}$, $C_I = 0.33\ \mu\text{F}$, $C_O = 0.1\ \mu\text{F}$. (Continued)

LM78L12AC Unless otherwise specified, $V_{IN} = 19\text{V}$

Symbol	Parameter	Conditions	Min	Typ	Max	Units
V_O	Output Voltage		11.5	12	12.5	V
		$14.5\text{V} \leq V_{IN} \leq 27\text{V}$ $1\text{ mA} \leq I_O \leq 40\text{ mA}$ (Note 3)	11.4		12.6	
		$1\text{ mA} \leq I_O \leq 70\text{ mA}$ (Note 3)	11.4		12.6	
ΔV_O	Line Regulation	$14.5\text{V} \leq V_{IN} \leq 27\text{V}$		30	180	mV
		$16\text{V} \leq V_{IN} \leq 27\text{V}$		20	110	
ΔV_O	Load Regulation	$1\text{ mA} \leq I_O \leq 100\text{ mA}$		30	100	mV
		$1\text{ mA} \leq I_O \leq 40\text{ mA}$		10	50	
I_Q	Quiescent Current			3	5	mA
ΔI_Q	Quiescent Current Change	$16\text{V} \leq V_{IN} \leq 27\text{V}$			1	
		$1\text{ mA} \leq I_O \leq 40\text{ mA}$			0.1	
V_n	Output Noise Voltage			80		μV
$\frac{\Delta V_{IN}}{\Delta V_{OUT}}$	Ripple Rejection	$f = 120\text{ Hz}$ $15\text{V} \leq V_{IN} \leq 25\text{V}$	40	54		dB
I_{PK}	Peak Output Current			140		mA
$\frac{\Delta V_O}{\Delta T}$	Average Output Voltage Tempco	$I_O = 5\text{ mA}$		-1.0		$\text{mV}/^\circ\text{C}$
V_{IN} (Min)	Minimum Value of Input Voltage Required to Maintain Line Regulation			13.7	14.5	V

LM78LXXAC Electrical Characteristics

Limits in standard typeface are for $T_J = 25^\circ\text{C}$, **bold typeface applies over the 0°C to $+125^\circ\text{C}$ temperature range.** Limits are guaranteed by production testing or correlation techniques using standard Statistical Quality Control (SQC) methods. Unless otherwise specified: $I_O = 40\text{ mA}$, $C_I = 0.33\ \mu\text{F}$, $C_O = 0.1\ \mu\text{F}$. (Continued)

LM78L15AC Unless otherwise specified, $V_{IN} = 23\text{V}$

Symbol	Parameter	Conditions	Min	Typ	Max	Units
V_O	Output Voltage		14.4	15.0	15.6	V
		$17.5\text{V} \leq V_{IN} \leq 30\text{V}$ $1\text{ mA} \leq I_O \leq 40\text{ mA}$ (Note 3)	14.25		15.75	
		$1\text{ mA} \leq I_O \leq 70\text{ mA}$ (Note 3)	14.25		15.75	
ΔV_O	Line Regulation	$17.5\text{V} \leq V_{IN} \leq 30\text{V}$		37	250	mV
		$20\text{V} \leq V_{IN} \leq 30\text{V}$		25	140	
ΔV_O	Load Regulation	$1\text{ mA} \leq I_O \leq 100\text{ mA}$		35	150	mV
		$1\text{ mA} \leq I_O \leq 40\text{ mA}$		12	75	
I_Q	Quiescent Current			3	5	mA
ΔI_Q	Quiescent Current Change	$20\text{V} \leq V_{IN} \leq 30\text{V}$			1	
		$1\text{ mA} \leq I_O \leq 40\text{ mA}$			0.1	
V_n	Output Noise Voltage			90		μV
$\frac{\Delta V_{IN}}{\Delta V_{OUT}}$	Ripple Rejection	$f = 120\text{ Hz}$ $18.5\text{V} \leq V_{IN} \leq 28.5\text{V}$	37	51		dB
I_{PK}	Peak Output Current			140		mA
$\frac{\Delta V_O}{\Delta T}$	Average Output Voltage Tempco	$I_O = 5\text{ mA}$		-1.3		$\text{mV}/^\circ\text{C}$
V_{IN} (Min)	Minimum Value of Input Voltage Required to Maintain Line Regulation			16.7	17.5	V

Note 1: Absolute Maximum Ratings indicate limits beyond which damage to the device may occur. Electrical specifications do not apply when operating the device outside of its stated operating conditions.

Note 2: Human body model, 1.5 k Ω in series with 100 pF.

Note 3: Power dissipation $\leq 0.75\text{W}$.

Note 4: Recommended minimum load capacitance of 0.01 μF to limit high frequency noise.

Note 5: Typical thermal resistance values for the packages are:

H Package: $R_{th}(J-C) = 26\ ^\circ\text{C}/\text{W}$, $R_{th}(J-A) = 120\ ^\circ\text{C}/\text{W}$

Z Package: $R_{th}(J-C) = 60\ ^\circ\text{C}/\text{W}$, $R_{th}(J-A) = 230\ ^\circ\text{C}/\text{W}$

M Package: $R_{th}(J-A) = 180\ ^\circ\text{C}/\text{W}$

Typical Performance Characteristics

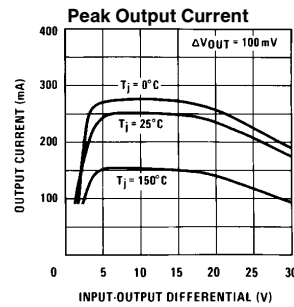
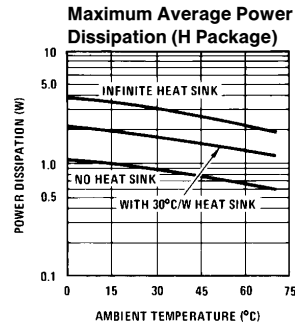
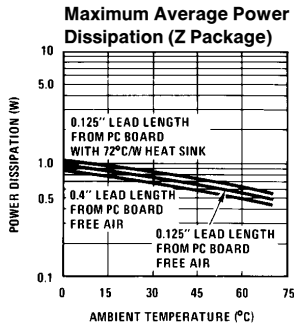

TL/H/7744-4

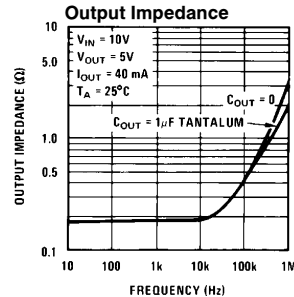
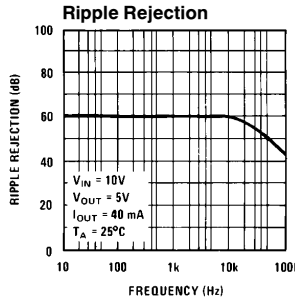
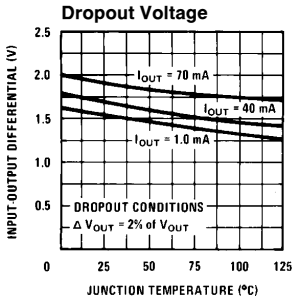

TL/H/7744-5

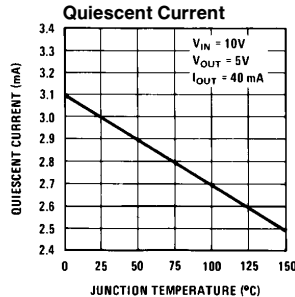
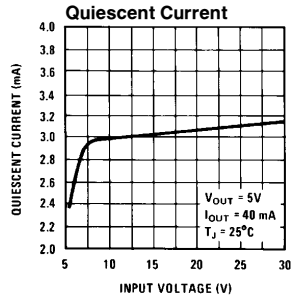

TL/H/7744-6

Equivalent Circuit

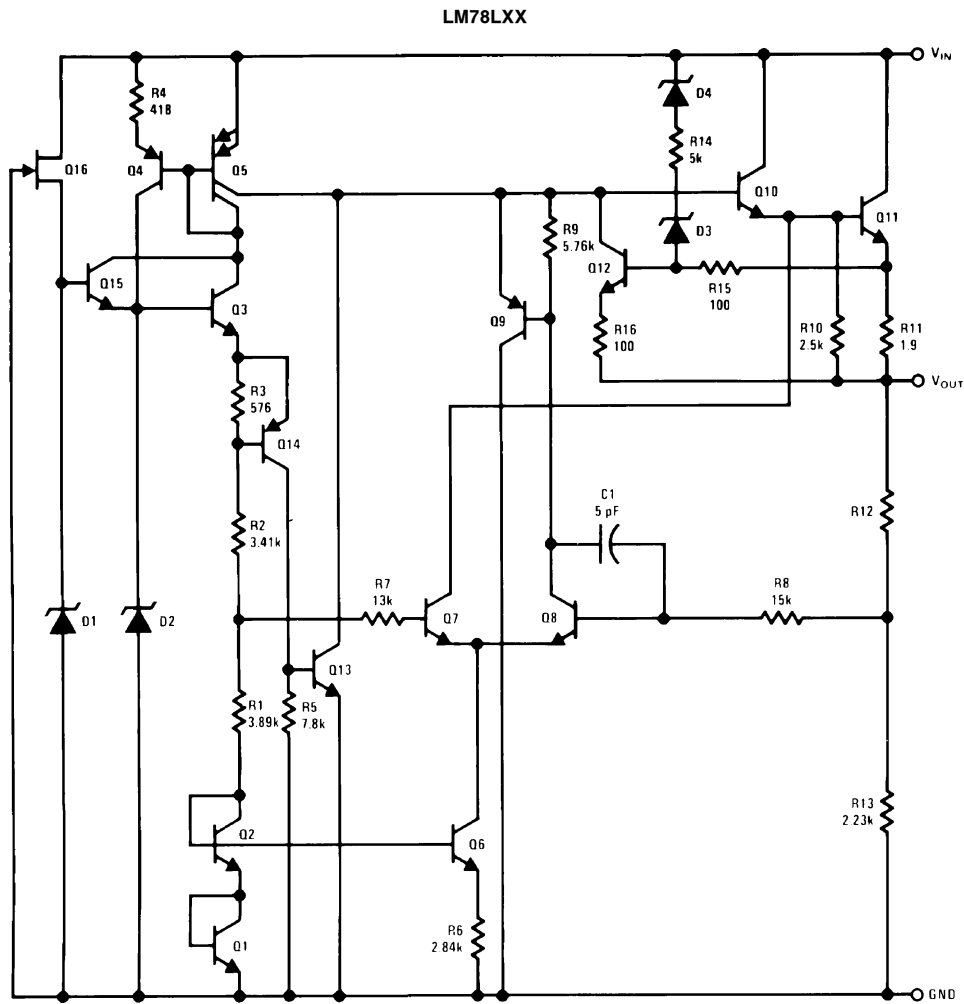

TL/H/7744-7

Typical Applications

Fixed Output Regulator

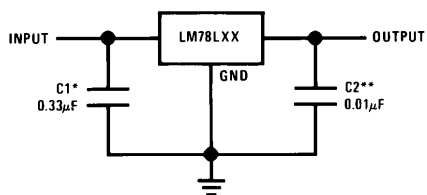

TL/H/7744-8

*Required if the regulator is located more than 3" from the power supply filter.

** See Note 4 in the electrical characteristics table.

Adjustable Output Regulator

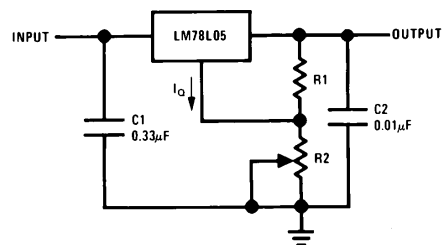

TL/H/7744-9

$$V_{OUT} = 5V + (5V/R1 + I_O) R2$$

$$5V/R1 > 3 I_O, \text{ load regulation } (L_r) \approx [(R1 + R2)/R1] \text{ (} L_r \text{ of LM78L05)}$$

Typical Applications (Continued)

Current Regulator

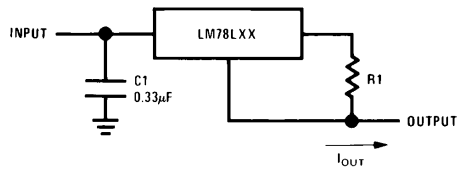

$$I_{OUT} = (V_{OUT}/R1) + I_Q$$

$$> I_Q = 1.5 \text{ mA over line and load changes}$$

TL/H/7744-10

5V, 500 mA Regulator with Short Circuit Protection

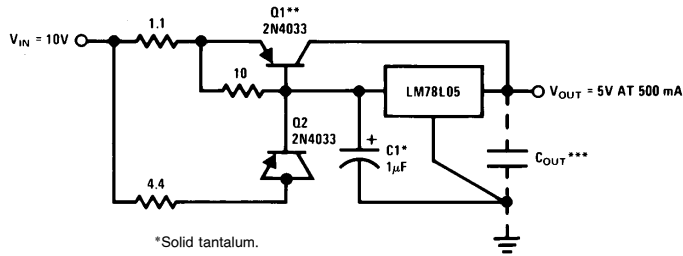

*Solid tantalum.

**Heat sink Q1.

***Optional: Improves ripple rejection and transient response.

Load Regulation: $0.6\% \ 0 \leq I_L \leq 250 \text{ mA}$ pulsed with $t_{ON} = 50 \text{ ms}$.

TL/H/7744-11

± 15V, 100 mA Dual Power Supply

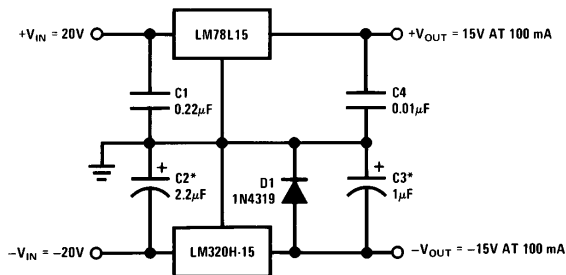

*Solid tantalum.

TL/H/7744-12

Variable Output Regulator 0.5V-18V

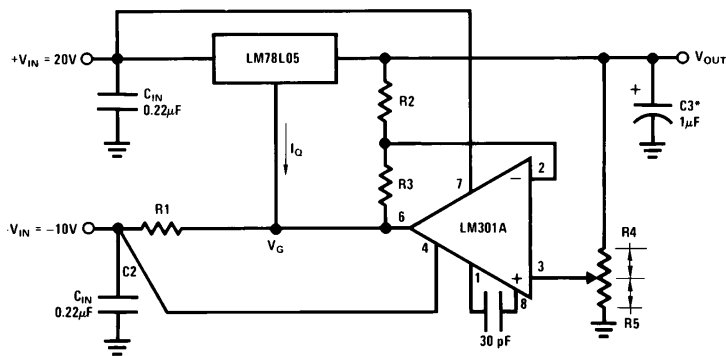

*Solid tantalum.

$$V_{OUT} = V_G + 5V, R1 = (-V_{IN}/I_Q \text{ LM78L05})$$

$$V_{OUT} = 5V (R2/R4) \text{ for } (R2 + R3) = (R4 + R5)$$

$$\text{A } 0.5V \text{ output will correspond to } (R2/R4) = 0.1 \text{ } (R3/R4) = 0.9$$

TL/H/7744-13

Physical Dimensions inches (millimeters)

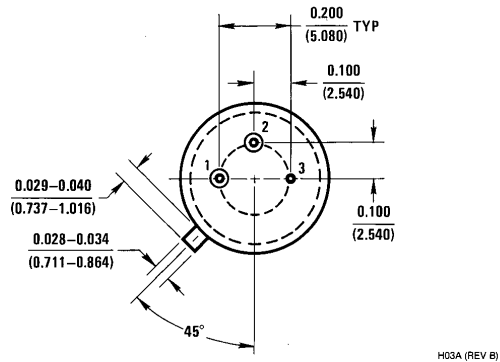
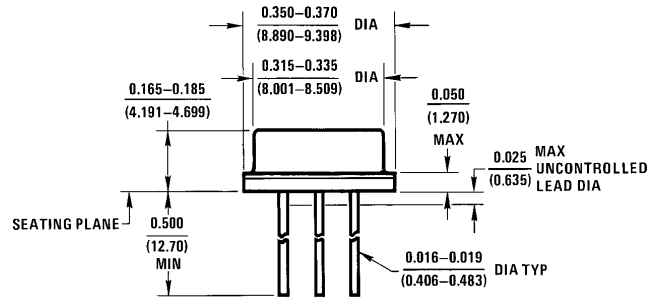

Metal Can Package (H)
Order Number LM78L05ACH, LM78L12ACH or LM78L15ACH
NS Package Number H03A

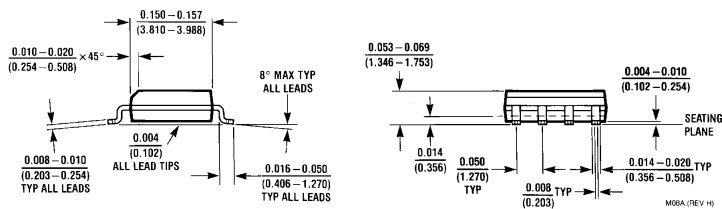
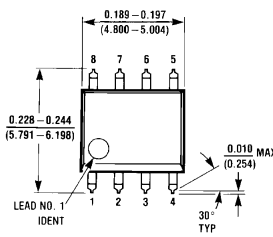

S.O. Package (M)
Order Number LM78L05ACM, LM78L12ACM or LM78L15ACM
NS Package Number M08A

Physical Dimensions inches (millimeters) (Continued)

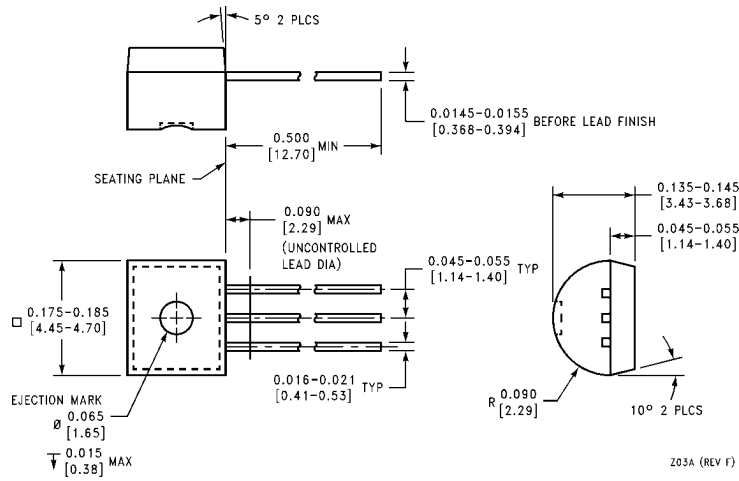

Z03A (REV F)

Molded Offset TO-92 (Z)
Order Number LM78L05ACZ, LM78L09ACZ, LM78L62ACZ,
LM78L82ACZ, LM78L12ACZ or LM78L15ACZ
NS Package Number Z03A

LIFE SUPPORT POLICY

NATIONAL'S PRODUCTS ARE NOT AUTHORIZED FOR USE AS CRITICAL COMPONENTS IN LIFE SUPPORT DEVICES OR SYSTEMS WITHOUT THE EXPRESS WRITTEN APPROVAL OF THE PRESIDENT OF NATIONAL SEMICONDUCTOR CORPORATION. As used herein:

1. Life support devices or systems are devices or systems which, (a) are intended for surgical implant into the body, or (b) support or sustain life, and whose failure to perform, when properly used in accordance with instructions for use provided in the labeling, can be reasonably expected to result in a significant injury to the user.
2. A critical component is any component of a life support device or system whose failure to perform can be reasonably expected to cause the failure of the life support device or system, or to affect its safety or effectiveness.

 <p>National Semiconductor Corporation 1111 West Bardin Road Arlington, TX 76017 Tel: 1(800) 272-9959 Fax: 1(800) 737-7018</p>	<p>National Semiconductor Europe Fax: (+49) 0-180-530 85 86 Email: cnjwge@tevm2.nsc.com Deutsch Tel: (+49) 0-180-530 85 85 English Tel: (+49) 0-180-532 78 32 Français Tel: (+49) 0-180-532 93 58 Italiano Tel: (+49) 0-180-534 16 80</p>	<p>National Semiconductor Hong Kong Ltd. 19th Floor, Straight Block, Ocean Centre, 5 Canton Rd. Tsimshatsui, Kowloon Hong Kong Tel: (852) 2737-1600 Fax: (852) 2736-9960</p>	<p>National Semiconductor Japan Ltd. Tel: 81-043-299-2309 Fax: 81-043-299-2408</p>
--	--	---	---

National does not assume any responsibility for use of any circuitry described, no circuit patent licenses are implied and National reserves the right at any time without notice to change said circuitry and specifications.