

<b>SANYO</b>	No. 4092A	LA1862M
	Single-chip Tuner System for Car Stereo	

### OVERVIEW

The LA1862M is a single-chip car stereo FM IF/NC/MPX tuner IC which offers improved IF stability and S-meter characteristics, compared with the LA1861M.

The LA1862M incorporates an IF amplifier, peak detector, AF preamplifier, AFC output, S-meter driver, soft mute circuit, IF buffer output, noise canceller, adjustment-free VCO, pilot signal canceller, high-cut control and SNC on-chip, making the design of high-performance FM tuners easy.

The LA1862M operates from a 7.5 to 10 V supply and is available in 36-pin MFPs.

### FEATURES

- Pin compatible with the LA1861M
- Improved I/O S-meter characteristics
- Excellent sound quality at low input levels
- Easy adjustment of muting characteristics
- IF amplifier
- Peak detector
- AF preamplifier
- AFC output
- S-meter driver
- Soft mute circuit
- IF buffer output
- Noise canceller
- Adjustment-free VCO
- Pilot signal canceller
- 7.5 to 10 V supply
- 36-pin MFP

### PIN ASSIGNMENT

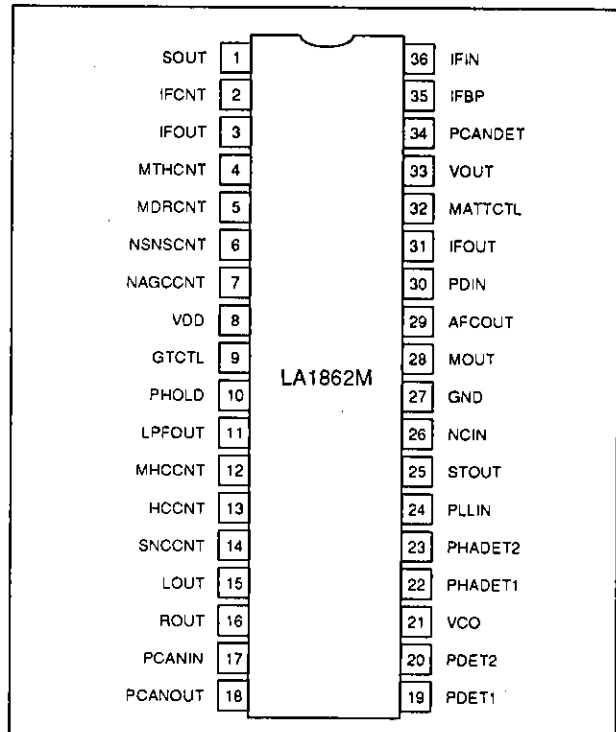

### PACKAGE DIMENSIONS

Unit: mm

#### 3129-MFP36S

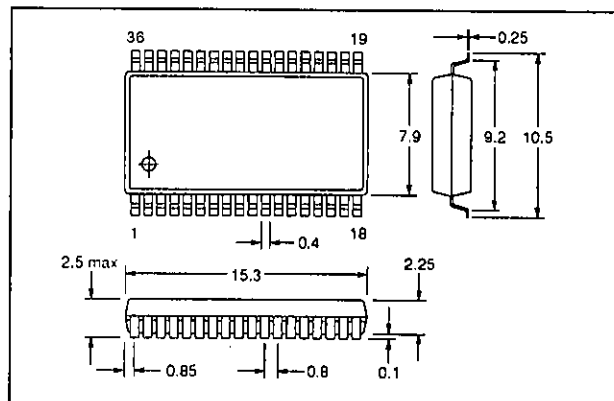

BLOCK DIAGRAM

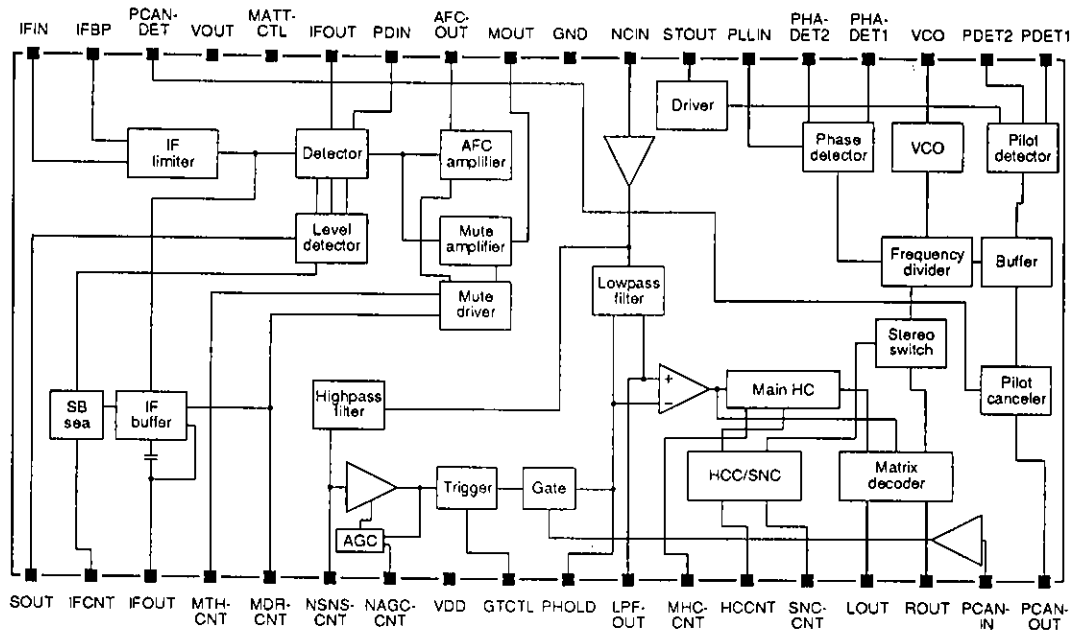

PIN DESCRIPTION

Number	Name	Description
1	SOUT	S-meter output
2	IFCNT	IF buffer sensitivity control
3	IFOUT	IF buffer output
4	MTHCNT	Muting threshold control
5	MDRCNT	Muting drive control output
6	NSNSCNT	Noise sensitivity control
7	NAGCCNT	Noise AGC sensitivity control
8	VCC	Supply voltage
9	GTCTL	Gate time control output
10	PHOLD	Peak hold network connection
11	LPFOUT	Lowpass filter output
12	MHCNT	Main high-cut attenuation control
13	HCCNT	High-cut control
14	SNCNT	SNC control
15	LOUT	MPX left-channel audio output
16	ROUT	MPX right-channel audio output
17	PCANIN	Pilot cancel signal input
18	PCANOUT	Pilot cancel signal output
19	PDET1	Pilot detector capacitor connection 1
20	PDET2	Pilot detector capacitor connection 2
21	VCO	External VCO crystal (F23) oscillator connection
22	PDET1	Phase detector network connection 1

## LA1862M

Number	Name	Description
23	PDET2	Phase detector network connection 2
24	PLLIN	PLL input
25	STOUT	Stereo indicator LED driver output
26	NCIN	Noise canceller input
27	GND	Ground
28	MOUT	Audio muting amplifier output
29	AFCOUT	AFC output
30	PDIN	Peak detector input
31	IFOUT	IF signal output
32	MATTCTL	Muting attenuation control
33	VOUT	Voltage reference output
34	PCANDET	Pilot signal canceller detector connection
35	IFBP	IF bypass input
36	IFIN	IF input

## SPECIFICATIONS

### Absolute Maximum Ratings

$T_a = 25\text{ }^\circ\text{C}$

Parameter	Symbol	Rating	Unit
Supply voltage	$V_{CC}$	10	V
IF input voltage range	$V_{IIF}$	-0.7 to +0.7	$V_{p-p}$
NCIN input voltage	$V_{IMPX}$	1	$V_{rms}$
Input current	$I_i$	20	mA
Output current	$I_o$	1	mA
Power dissipation	$P_D$	720	mW
Operating temperature range	$T_{opT}$	-30 to +80	$^\circ\text{C}$
Storage temperature range	$T_{stg}$	-40 to +150	$^\circ\text{C}$

### Recommended Operating Conditions

$T_a = 25\text{ }^\circ\text{C}$

Parameter	Symbol	Rating	Unit
Supply voltage	$V_{CC}$	8.5	V
Supply voltage range	$V_{CC}$	7.5 to 10	V

LA1862M

**Electrical Characteristics**

T<sub>a</sub> = 25 °C, V<sub>CC</sub> = 8.5 V, f = 10.7 MHz unless otherwise noted

Parameter	Symbol	Condition	Rating			Unit
			min	typ	max	
Quiescent current	I <sub>CCO</sub>	No input signal	-	45	70	mA
Operating current	I <sub>CC</sub>	V <sub>I</sub> = 100 dBμ	-	47	72	mA
LOUT demodulator output voltage	V <sub>O</sub>	V <sub>I</sub> = 100 dBμ, f = 1 kHz, 100% modulation	225	350	495	mV <sub>rms</sub>
Total harmonic distortion	THD	Mono, V <sub>I</sub> = 100 dBμ, f = 1 kHz, 100% modulation	-	0.3	1.2	%
		Stereo (L + R), V <sub>I</sub> = 100 dBμ, f = 1 kHz, 100% modulation	-	0.3	1.2	
Signal-to-noise ratio	S/N	V <sub>I</sub> = 100 dBμ, f = 1 kHz, 100% modulation	64	71	-	dB
Input limiting voltage	V <sub>LIM</sub>	V <sub>I</sub> = 100 dBμ reference, 3 dB audio output attenuation, IF input level, soft muting ON, f = 1 kHz, 100% modulation	32	41	50	dBμ
Mute attenuation	α <sub>MUTE</sub>	V <sub>MDCNT</sub> = 5 V, V <sub>I</sub> = 100 dBμ, f = 1 kHz, 100% modulation	21	25	29	dB
		V <sub>MDCNT</sub> = 2 V, V <sub>I</sub> = 100 dBμ, f = 1 kHz, 100% modulation	5	10	15	
Mute bandwidth	BW <sub>MUTE</sub>	V <sub>MDCNT</sub> = 2 V, V <sub>I</sub> = 100 dBμ	135	200	305	kHz
AM rejection ratio	AMR	V <sub>I</sub> = 100 dBμ, 400 Hz, 100% modulated FM carrier, 1 kHz, 30% modulated AM interference signal	47	60	-	dB
Muting drive output voltage	V <sub>MDCNT</sub>	No input signal	3.5	4.7	-	V
		V <sub>I</sub> = 100 dBμ	-	0	0.3	
S-meter output voltage	V <sub>SOUT</sub>	No input signal	-	0.1	0.5	V
		V <sub>I</sub> = 50 dBμ	1.1	1.9	2.7	
		V <sub>I</sub> = 100 dBμ	5.4	6.4	7.4	
IF COUNT output sensitivity	S <sub>ICO</sub>	At IF COUNT ON, SW-1 is ON.	44	53	62	dBμ
IF buffer output voltage	V <sub>IF</sub>	V <sub>I</sub> = 100 dBμ, SW-1 is ON.	200	300	480	mV <sub>rms</sub>
Input impedance	Z <sub>I</sub>	f = 1 kHz	-	20	-	kΩ
Output noise voltage	V <sub>NO</sub>	NCIN connected to ground	-	27	-	μV
Gate time	t <sub>gate</sub>	V <sub>I</sub> = 100 mV <sub>p-p</sub> , 1 μs pulsewidth, f = 1 kHz	13	23	35	μs
Noise sensitivity	S <sub>N</sub>	1 μs pulsewidth, f = 1 kHz	-	-	35	mV <sub>p-p</sub>

LA1862M

Parameter	Symbol	Condition	Rating			Unit
			min	typ	max	
Channel separation	Sep	f = 1 kHz, 90% L + R signal modulation, 10% pilot signal modulation, IHF bandpass filter	36	50	-	dB
Stereo indicator threshold level	TL <sub>SI</sub>	Pilot signal level is measured when the LED turns ON.	1.0	2.5	5.0	%
Stereo indicator hysteresis	Hys	LED ON level → LED OFF level	-	3.2	6.5	dB
Capture range	CR	See note 2.	-	±1.2	-	%
SCA rejection	SCA <sub>rej</sub>	90% L + R signal modulation, 10% pilot signal modulation, 67 kHz, 10% modulated SCA signal	-	75	-	dB
SNC output attenuation	α <sub>SNC</sub>	V <sub>SNCNT</sub> = 0.6 V, 90% L - R signal modulation, 10% pilot signal modulation	-12	-7.5	-3.0	dB
SNC output voltage	V <sub>Osub</sub>	V <sub>SNCNT</sub> = 0.1 V, 90% L - R signal modulation, 10% pilot signal modulation	-	-	5	mV
High-cut control output attenuation	α <sub>HCC</sub>	V <sub>HCCNT</sub> = 0.6 V, 90% L + R signal modulation, 10% pilot signal modulation	-15	-5	0	dB
		V <sub>HCCNT</sub> = 1.1 V, 90% L + R signal modulation, 10% pilot signal modulation	-2.0	-	0	
Ripple rejection	R <sub>rej</sub>	f = 50 Hz, V <sub>i</sub> = 100 mV <sub>rms</sub>	-	27	-	dB
Channel balance (L <sub>OUT</sub> - R <sub>OUT</sub> )	CB	V <sub>i</sub> = 100 dBμ, f = 1 kHz (mono), 100% modulation	-	0	1.5	dB
Pilot signal attenuation	α <sub>PILOT</sub>	Left channel adjusted and measured, DIN audio filter. See note 1.	15	22	-	dB
Stereo indicator LED current	I <sub>OS</sub>	Minimum stereo drive current	1	-	-	mA
Stereo indicator LED saturation voltage	V <sub>SAT</sub>	I <sub>L</sub> = 10 mA	-	1	-	V

Notes

1. When a filter is not specified, connect an IHF bandpass filter to the audio outputs.
2. The capture range is calculated using the following equation.

$$CR = \left| \frac{f - 456}{456} \right| \times 100$$

Measurement Circuit

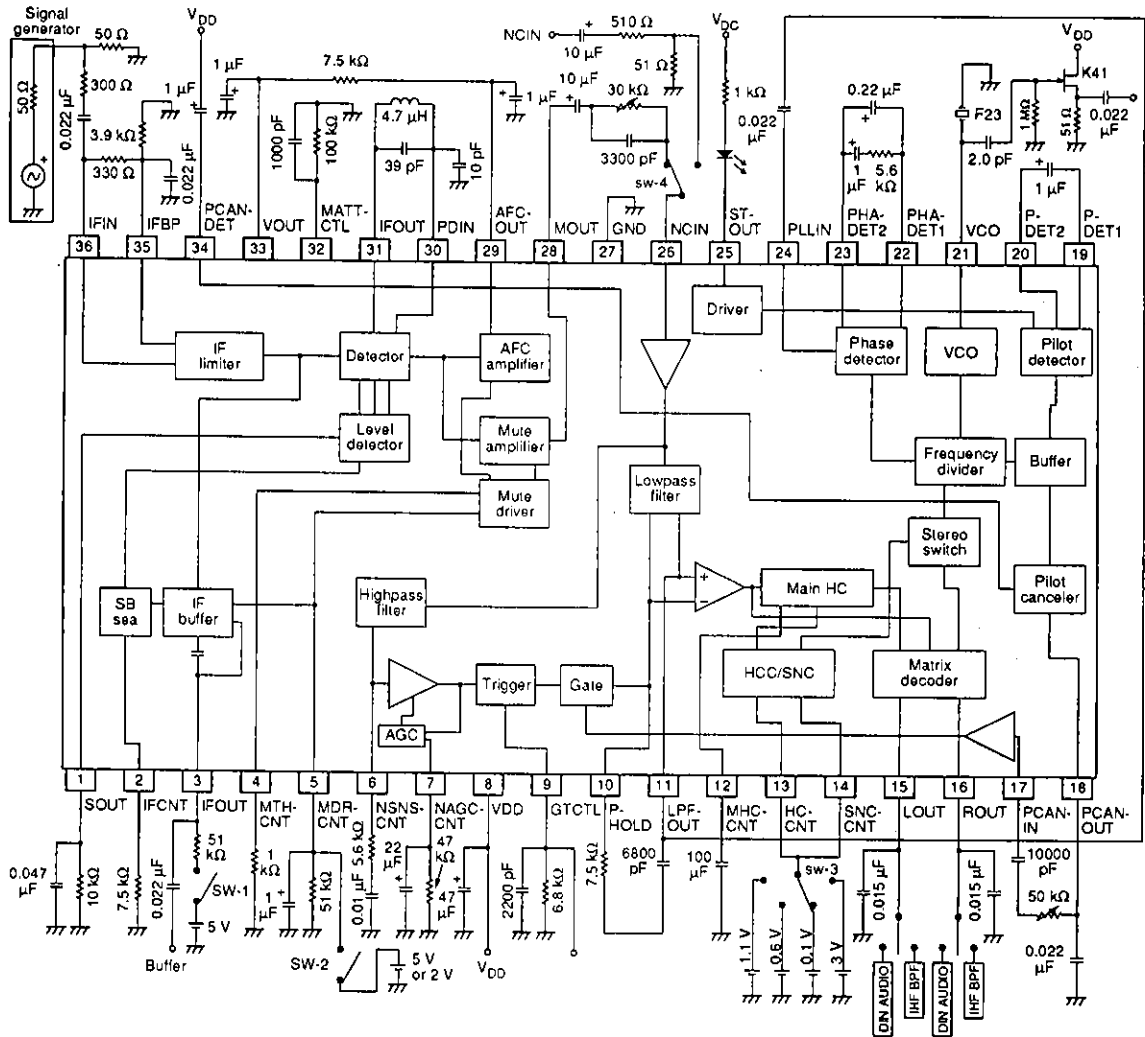

Typical Performance Characteristics

Maximum power dissipation vs. ambient temperature

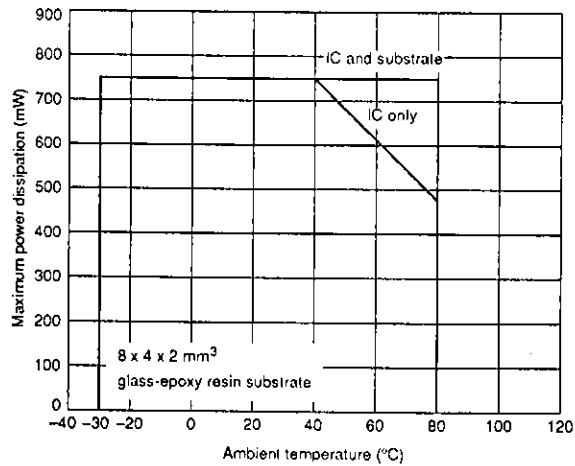

TYPICAL APPLICATION

Typical Circuit

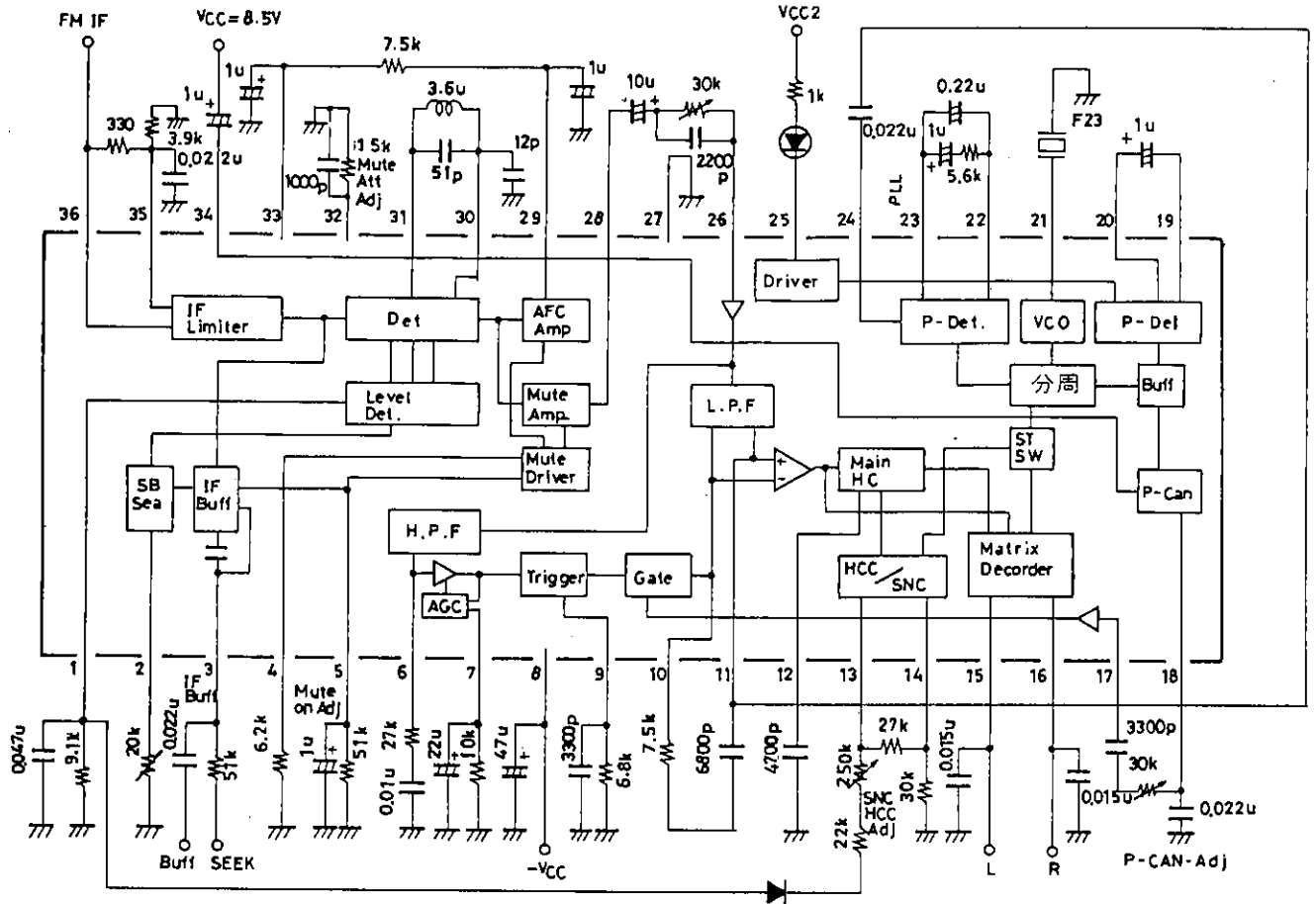

PCB Pattern

Unit (resistance: Ω, capacitance: F)

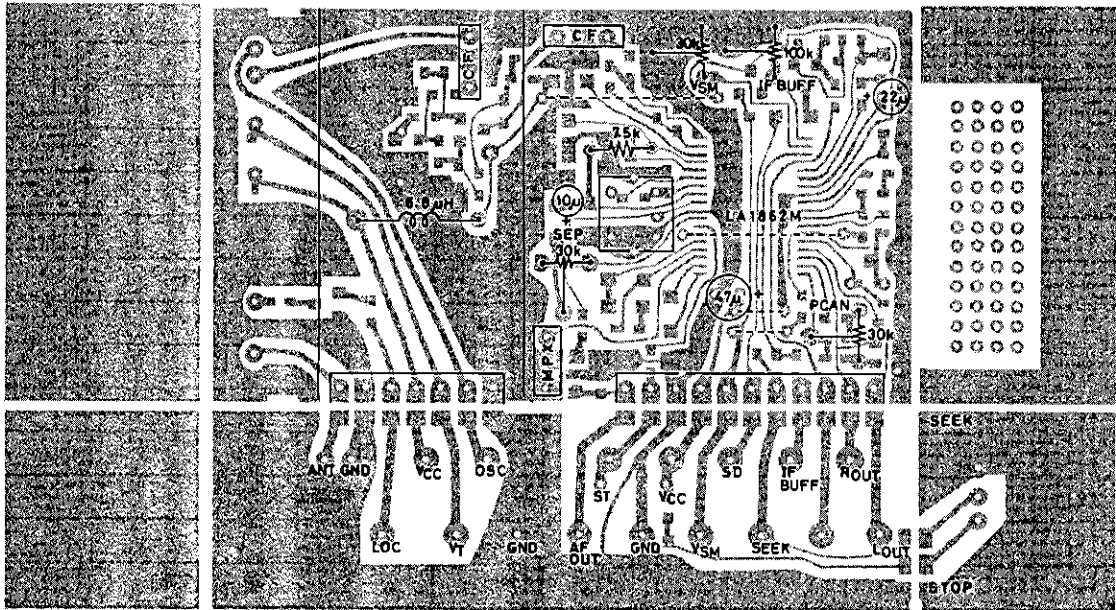

Typical Circuit (USA)

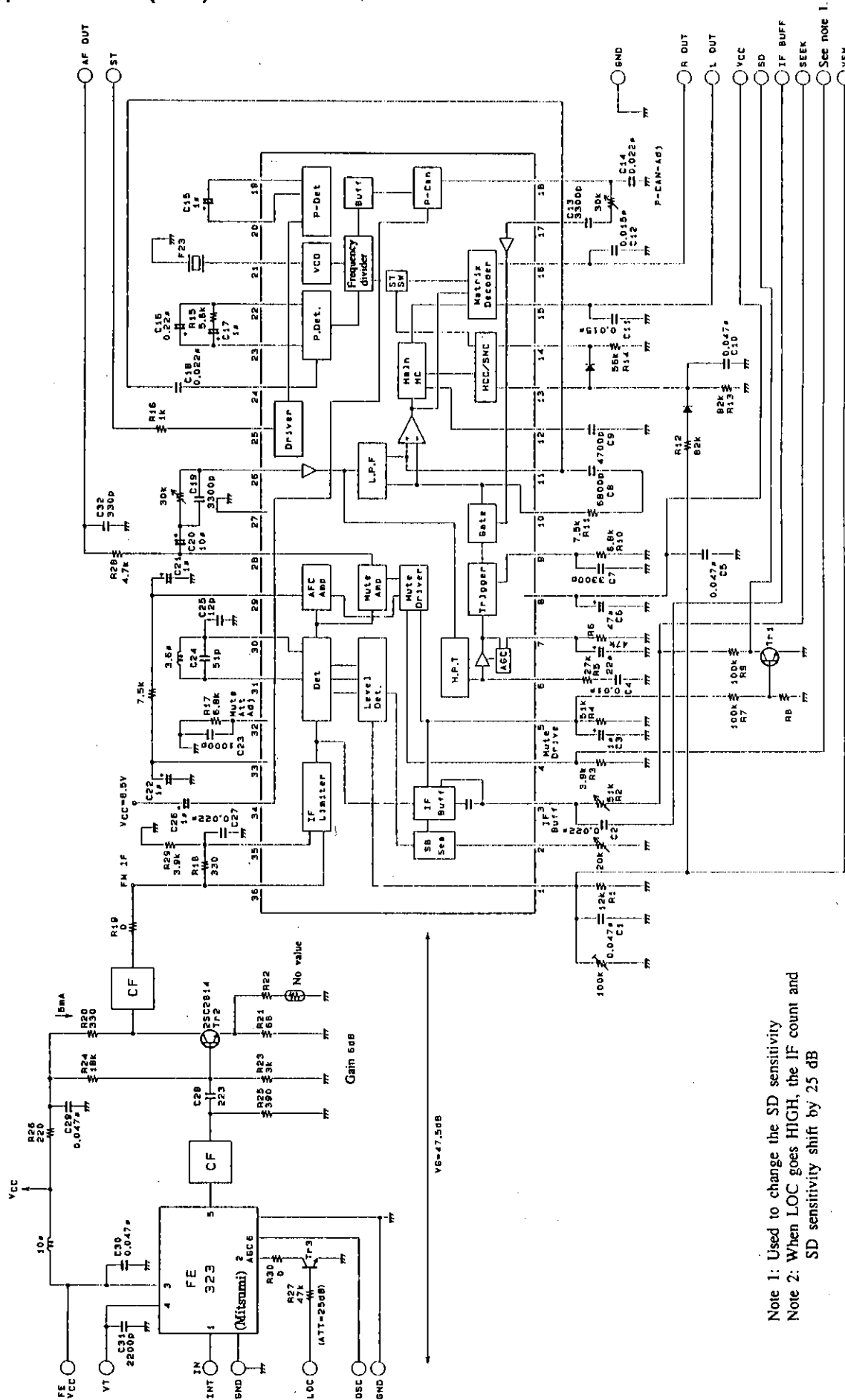

Note 1: Used to change the SD sensitivity  
 Note 2: When LOC goes HIGH, the IF count and SD sensitivity shift by 25 dB

Unit (resistance: Ω, capacitance: F)



FUNCTIONAL DESCRIPTION

Pin Functions

Unit (resistance:  $\Omega$ )

Number	Function	Equivalent circuit	Remarks
35	IF bypass		
36	IF input		
1	S-meter output		Current-drive waveform S-meter circuit
4	Mute adjust		
30	Peak detector input		
31	Constant voltage output		

LA1862M

Unit (resistance:  $\Omega$ )

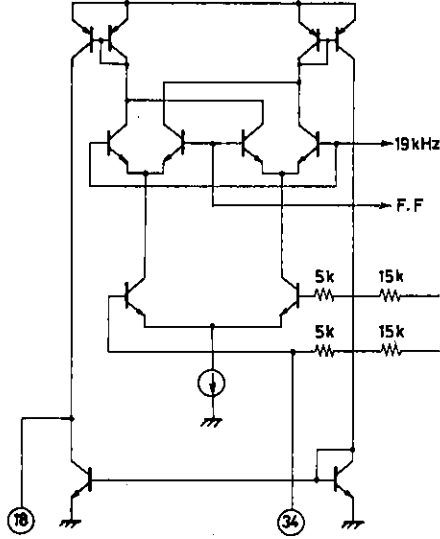
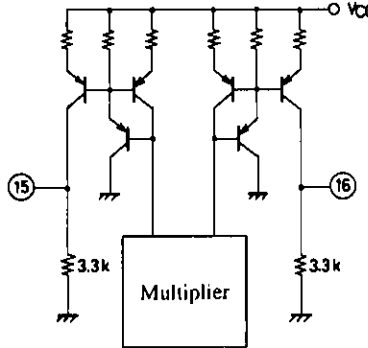
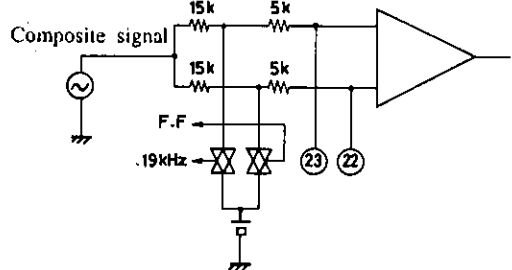
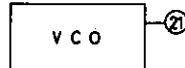
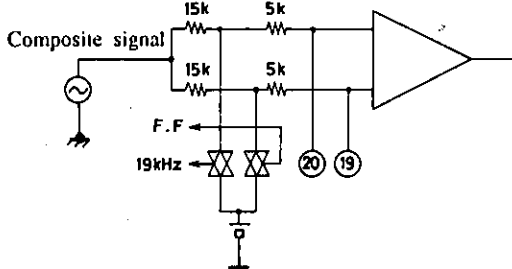
Number	Function	Equivalent circuit	Remarks
18	Pilot cancel signal output		
34	Pilot cancel signal detector		
15	MPX outputs		<p><math>R_{out} = 3.3\text{ k}\Omega</math> Load has built-in resistance</p>
16			
23	Phase detectors		
22			
21	VCO		
20	Pilot detectors		
19			

LA1862M

Unit (resistance:  $\Omega$ )

Number	Function	Equivalent circuit	Remarks
10	Memory circuit		
11	LPF output		
17	Pilot cancel signal input		
26	Noise canceller input		
12	High-cut capacitive coupling		High-cut frequency set pin
24	PLL input		
2	IF buffer ON adjust		

LA1862M

Number	Function	Equivalent circuit	Remarks
5	Mute drive		
6	Noise sensitivity adjust		
7	Noise AGC		
9	Gate time adjust		<p>The gate is open when the voltage on pin is 1.4 V (<math>2V_0</math>) or higher.</p>
33	Constant voltage circuit		

LA1862M

Unit (resistance:  $\Omega$ )

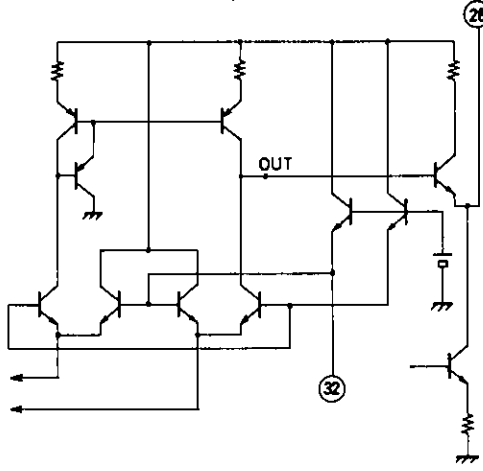
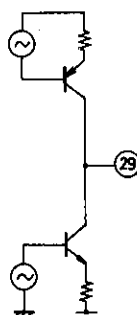
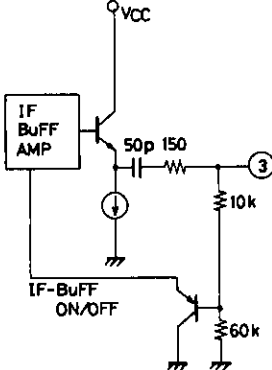
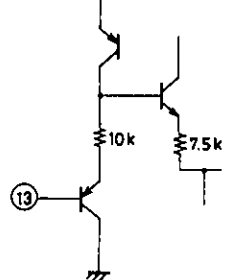
Number	Function	Equivalent circuit	Remarks
28	Muting circuit output		<p><math>Z_{out}</math> (pin 28) = 50 <math>\Omega</math></p>
32	Muting attenuation adjust		
29	AFC output		
3	IF buffer output		<p>Control signal: SEEK when HIGH (<math>V_{DD}</math>) and STOP when LOW (GND) Pin 3 should be left open if not using the IF count</p>
13	HCC control input		

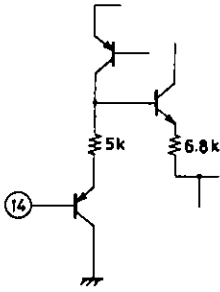
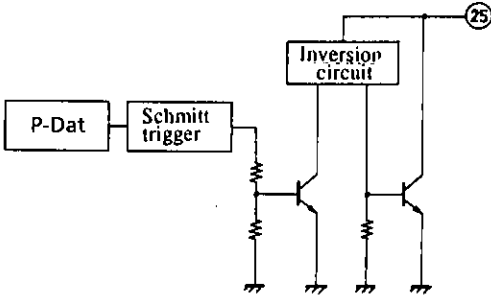
		Unit (resistance: $\Omega$ )	
Number	Function	Equivalent circuit	Remarks
14	SNC control input		
25	ST indicator		Mono when HIGH and stereo when LOW

**IF Block**

**Obtaining Stable Characteristics**

1. Pin 36 is the IF input; pin 35, the IF bypass. Connect a 330  $\Omega$  resistor between them for ceramic filter matching.
2. Position the capacitor between the IF bypass (pin 35) and the ground pattern so as to maximize AM rejection.
3. Provide separate ground pattern islands for the IF input and detection circuits, as sharing the same island reduces stability.
4. Position the IF input and detector coil as far apart as possible, as proximity reduces stability and introduces beat noise in the output.

**S-meter Output  $V_{SM}$**

1. Pin 1 is the field strength indicator (or "S-meter") output. Its current-driven circuit uses an external resistance to adjust the slopes of the I/O characteristics curves.
2. The S-meter output is internally connected to the soft muting and IF buffer blocks for use as a control signal for the soft muting drive and IF count buffer.
3. The point at which the input produces an S-meter output depends on the front end (FE) and interstage amplifier gains.
4. Too large a front end gain produces floating S-meter output even when there is no input. Either use a smaller load resistance on pin 1 or reduce the front end gain so that the output with no load does not exceed 0.5 V.
5. The S-meter output circuit has a dynamic range of approximately 80 dB, but this is limited by the front end noise component and broadband AGC circuit.

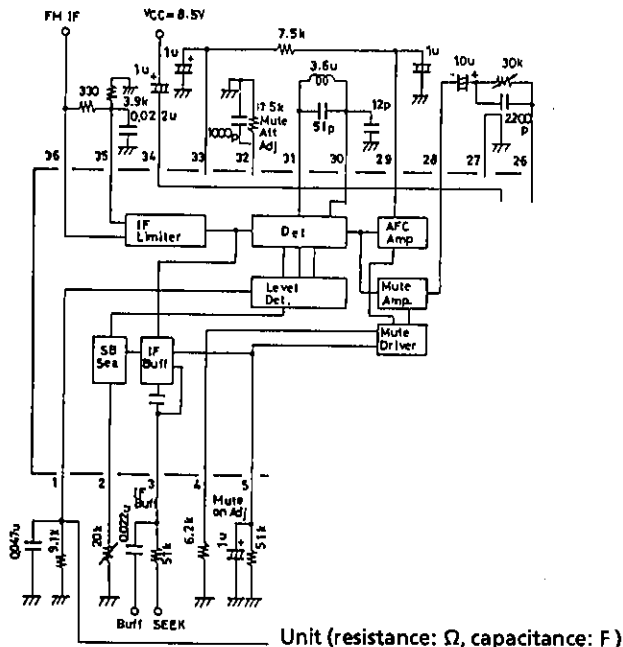

**Soft Muting**

1. The soft muting circuit operates in response to the S-meter output voltage. The amount of muting is related to the pin 5 output voltage.
2. There are two mechanisms for adjusting the soft muting I/O characteristic curve:
  - a. Start point for muting: Resistance attached to pin 4
  - b. Attenuation for muting: Resistance attached to pin 32

Note that the resistance attached to pin 1 also affects the curve.

- The soft muting circuit automatically varies the amount of muting in response to the IF input. In the absence of front end broadband AGC effects, the time constant of the RC circuit between pins 1 and 5 determines the response.

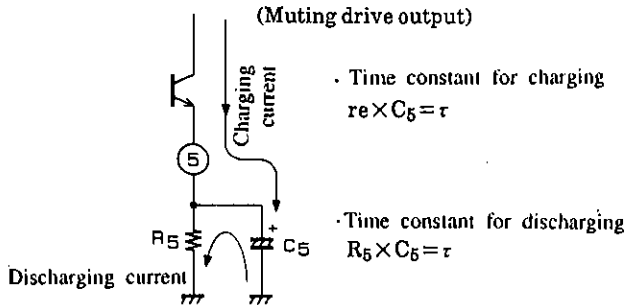

**Band Muting**

- Band muting uses the detector's S-curve. The bandwidth depends on the resistance between pins 29 and 33. Select this value to match the needs of the destination market.
- Keep in mind that changing the detector coil or tuning capacity Q changes the slope of the S-curve and hence the bandwidth.
- The attenuation muting depends on the resistance connected to pin 32.

**IF Count Buffer**

- Pin 3 is the IF count buffer output. To activate the IF count circuit, apply a 5 V input to pin 3 through a 51 kΩ resistor.
- The resistor connected to pin 2 determines the IF count buffer output sensitivity (seek stop sensitivity).
- Leave pins 2 and 3 open if the IF count buffer is not used.

- The muting transient response depends on the resistance between pins 29 and 33, the capacitance at pin 29, and the time constant for the RC circuit at pin 5.

**Detector**

- This IC uses a peak differential detector.
- To adjust the detector coil, use the built-in automatic frequency circuit (AFC) and rotate the coil core until the voltage drop between pins 29 and 33 is 0 V.
- Zeroing the AFC and minimizing the total harmonic distortion requires adjusting the capacitance between pin 30 and ground. Note that stray circuit board capacitance can affect this capacitance value.
- The level of demodulation that is output depends on the inductance of the coil between pins 30 and 31, tuning capacity Q and the capacitor size. Note that although raising Q increases the slope of the S-curve and thus the demodulation output, it does so at the risk of increasing distortion.
- If the destination market is Europe, increasing the slope of the S-curve helps reduce interference from neighboring channels.

- The largest time constant among those for the following pins determines the transient response characteristic of the IF count buffer. Pin 1, the S-meter output, pin 4, the start of muting, pin 5, the muting drive output and pin 29, the AFC output.

IF count system block diagram

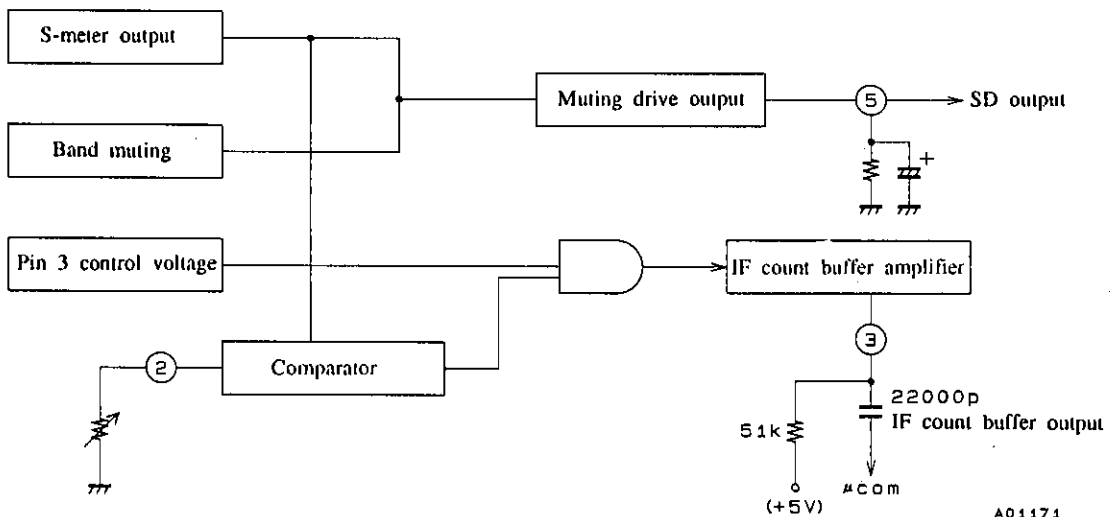

**Note**

The logical AND of the S-meter output and pin 3 control voltage generates the output 10.7 MHz IF count signal.

**SD Output**

1. To obtain SD output, attach an external NPN transistor to pin 5 as shown in the following figure.
2. The resistor connected between the base and ground is for adjusting the SD sensitivity.
3. The transient response characteristic of the resulting SD circuit on pin 5 is, like that for the IF count buffer, determined by the time constants for pins 1, 4, 5 and 29.

Raising the seek speed requires decreasing the time constants. Decreasing them too far, however, reduces muting transient response and risks introducing beat noise and other distortion.

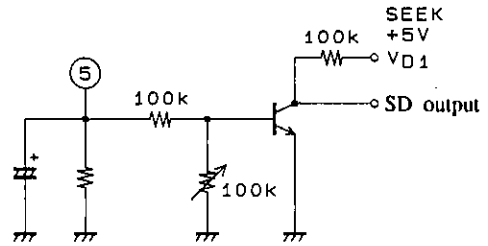
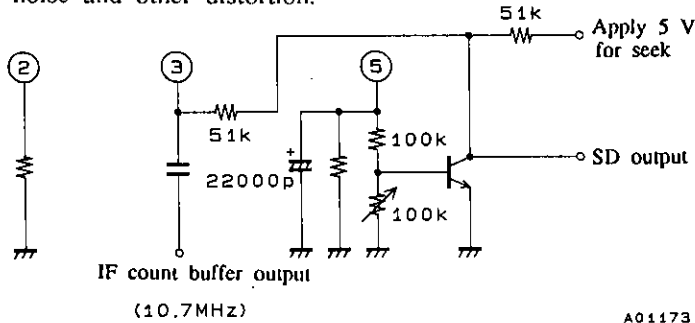

4. The following figure illustrates one possible circuit design using both the IF count buffer and the SD output circuit.

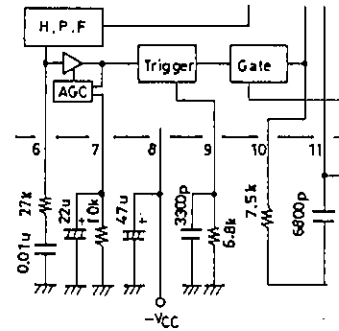

Unit (resistance:  $\Omega$ , capacitance: F)

**Noise Canceller Block**

Noise canceller input waveform

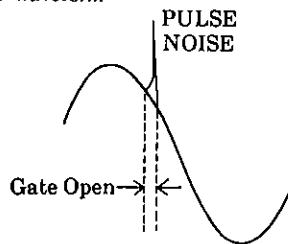

Noise canceller output waveform

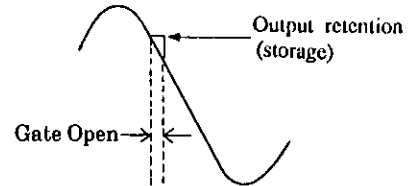

1. The resistor and capacitor connected to pin 6 determine the noise canceller sensitivity.
2. The resistor and capacitor connected to pin 7 determine the noise AGC.
3. Pin 9 is the gate trigger output. The resistor and capacitor connected to pin 9 determine the length of time that the gate is open.
4. The resistor and capacitor connected to pins 10 and 11 are for holding the input signal level when the noise canceller gate operates. The storage time

depends on the time that the gate is open. The time constant for the RC circuit on pins 10 and 11 must, therefore, be such that the output retention signal level does not drop during this interval.

5. Pin 26 is the noise canceller input. An appropriate input level is 250 mV<sub>rms</sub> for 100% dev and  $f_m = 1$  kHz. Excessive input can exceed the noise canceller dynamic range, increasing the THD. Insufficient input, on the other hand, lowers the signal-to-noise ratio and reduces pilot lamp sensitivity.



MPX Block

Unit (resistance: Ω, capacitance: F)

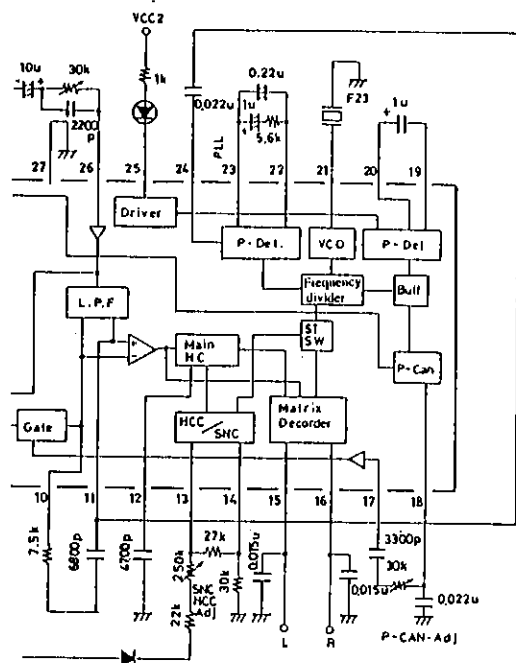

1. The variable resistor between pins 26 and 28 is for adjusting separation.
2. The ceramic oscillator must be a Murata F23. The use of other oscillators leads to frequency discrepancies and spurious oscillations.
3. Pin 14 is the SNC control input. It uses the S-meter output from pin 1 to automatically vary the stereo separation with the input signal strength. It is also possible to reduce noise resulting from weak stereo signals.
4. Pin 13 is the HCC control input. It uses the S-meter output from pin 1 to automatically vary the mul-

- tiplexer output high-frequency characteristic with the input signal strength. The capacitor at pin 12 determines the maximum attenuation for this band. Too big a capacitance, however, will degrade music quality and make the audibility unstable during reception.
5. Pin 24 is the 19 kHz pilot signal input. Capacitively couple the 19 kHz component from pin 11 to pin 24.
6. Pin 25 is the stereo lamp signal. Current flows only for stereo signals. Leaving the pin open forces monaural operation.
7. The VCO always operates during both stereo and monaural operation.
8. Pins 15 and 16 are the left- and right-channel outputs. The capacitors at these pins determine the amount of deemphasis—50 μs using 0.015 μF, and 75 μs using 0.022 μF.
9. Pin 18 is the pilot cancel signal output. Adjust the variable resistor between pins 17 and 18 to minimize the 19 kHz pilot signal components in the left- and right-channel outputs for correct channel balance.
10. When adjusting the pilot cancel signal output, connect a 20 kHz lowpass filter (for example, a DIN audio filter) to the multiplexer output to remove the 38 kHz component and prevent its affect on the process of minimizing the 19 kHz component.
11. The capacitor connected to pin 34 is used to detect the pilot cancel signal. It should be connected to V<sub>CC</sub> or GND. In the case of V<sub>CC</sub>, use a capacitor with no DC leakage.

Coil Specifications

600YEAS-6889GW (Toko)

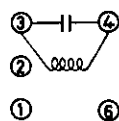

For European markets

C=100p Internal

600YEAS-6890GW (Toko)

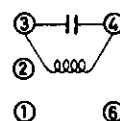

For North American and Japanese markets

C=51p Internal

M7-T1-31301 (Mitsumi)

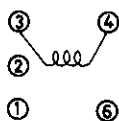

YD-0214  
For European markets

C=100p External

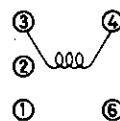

YD-9493-3  
For North American and Japanese markets

C=51p External

Note

The dotted lines in the characteristics diagrams on the following pages represent device operation outside the device specifications.

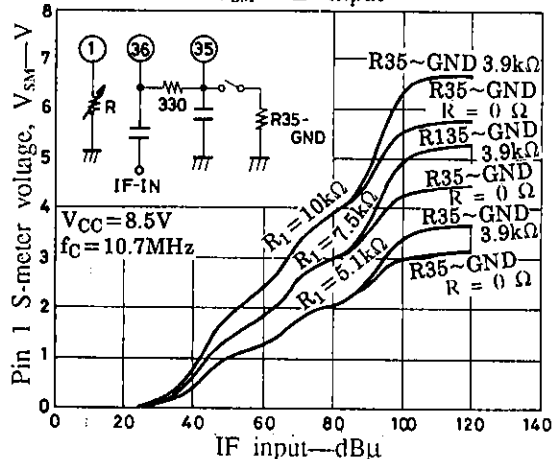
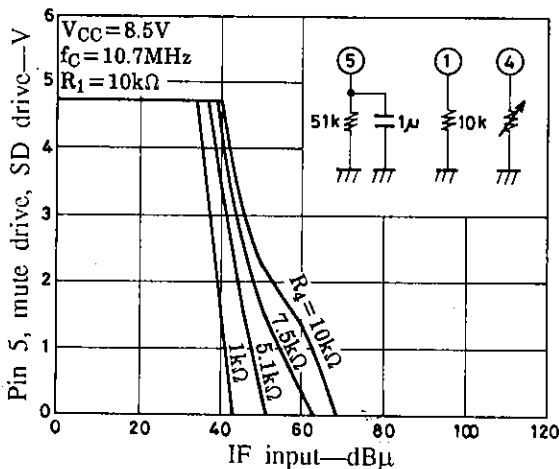
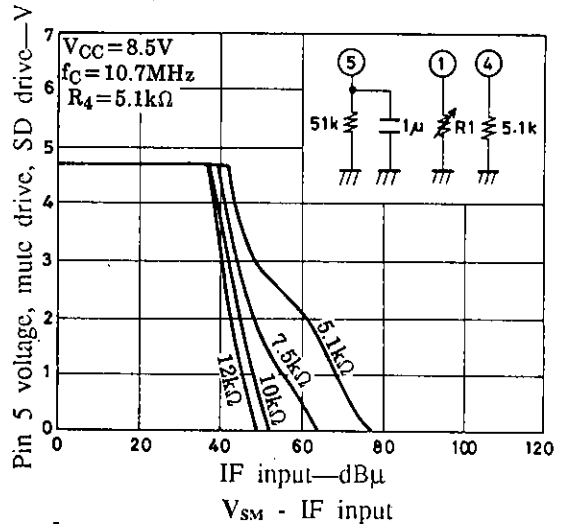
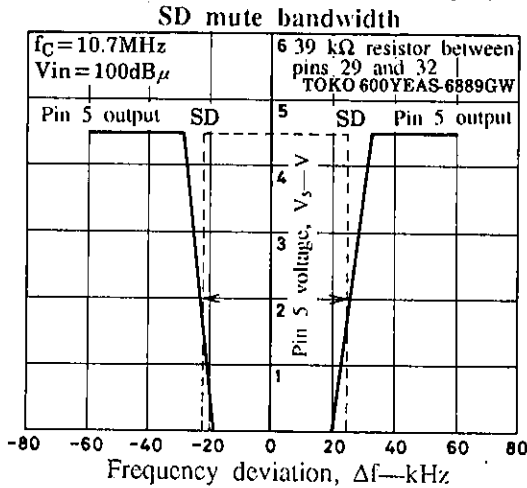
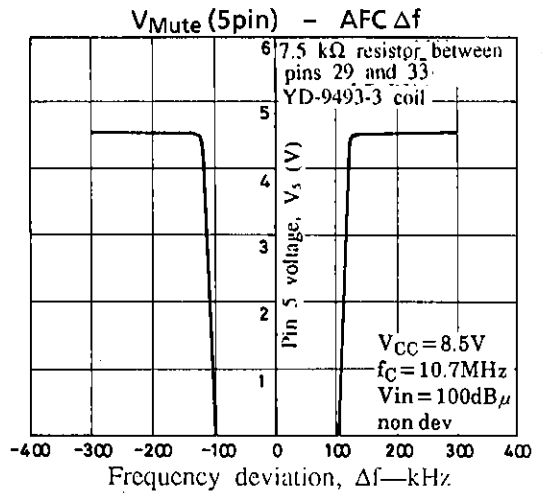
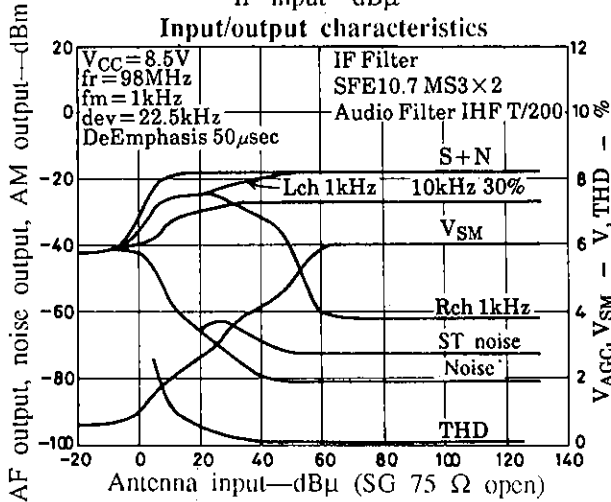
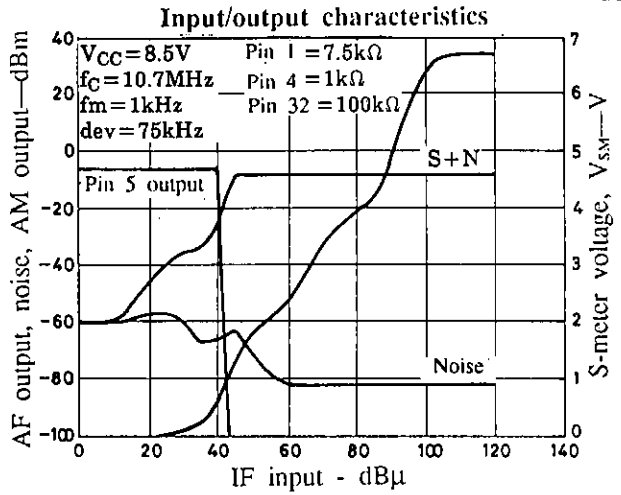
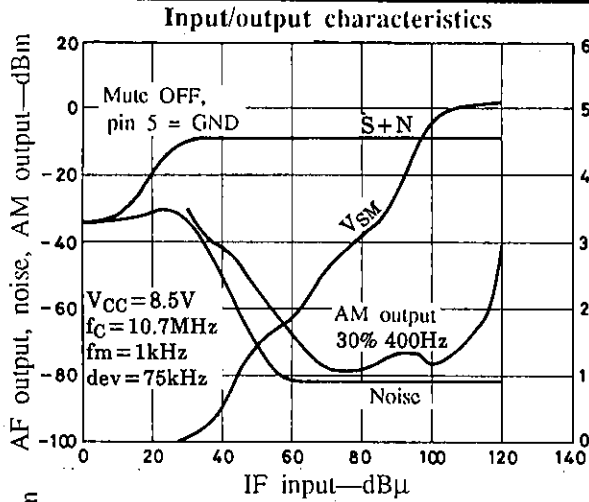

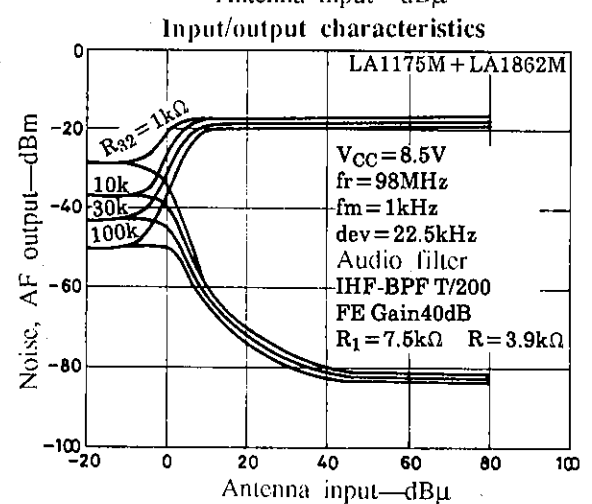
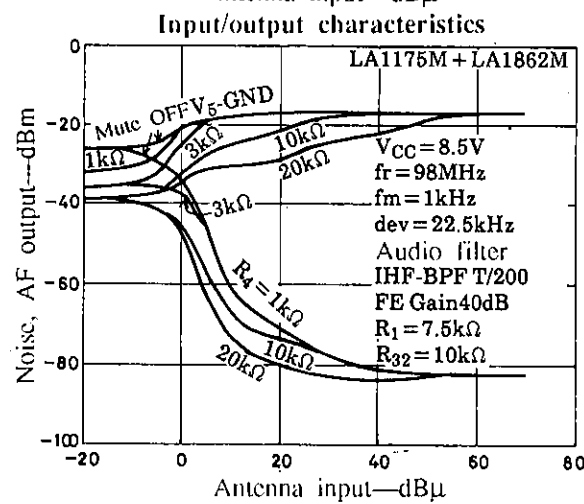
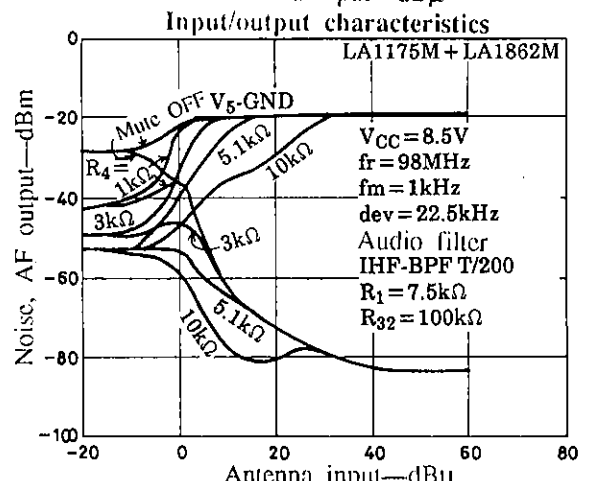
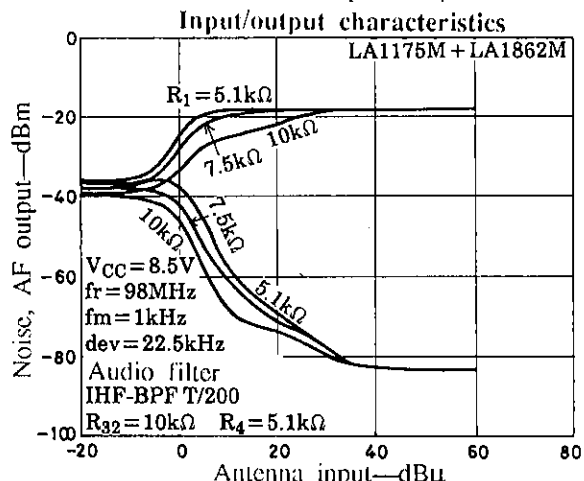
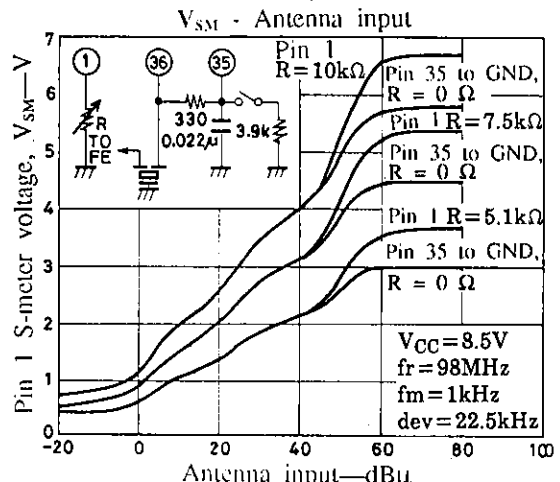
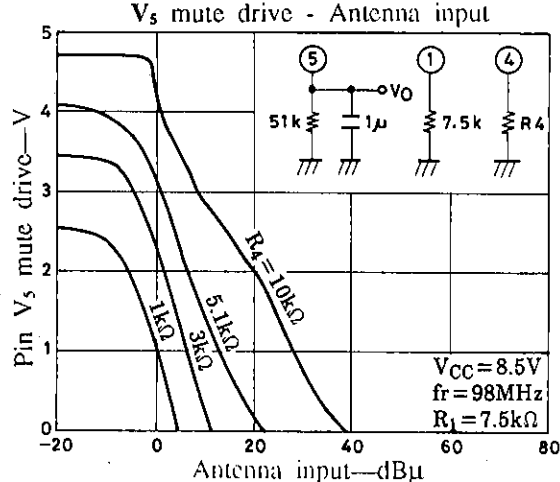
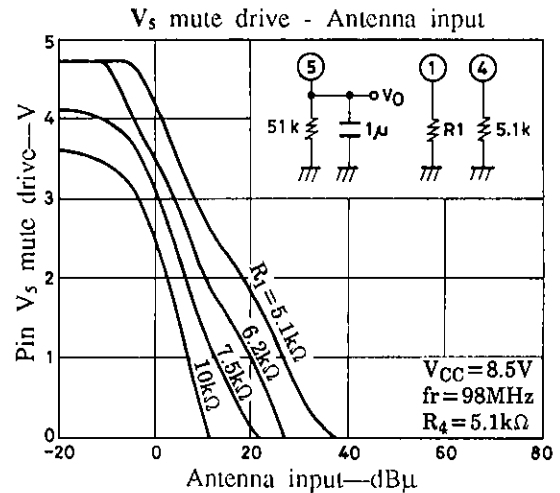
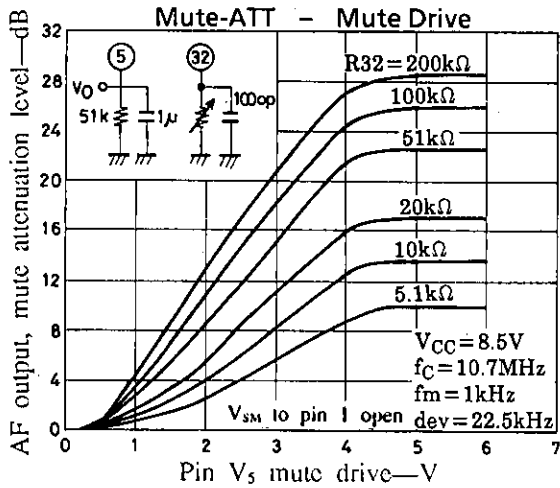

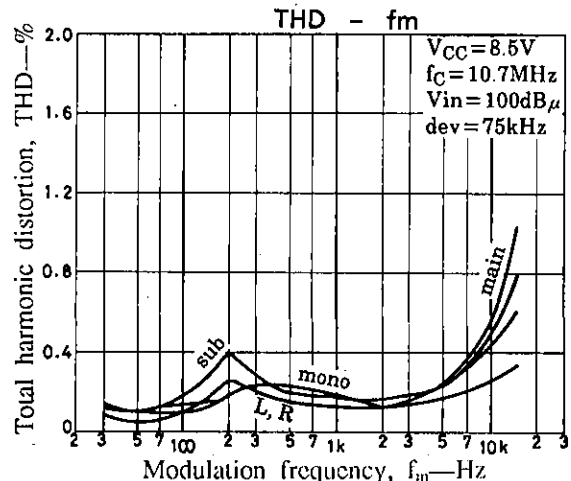
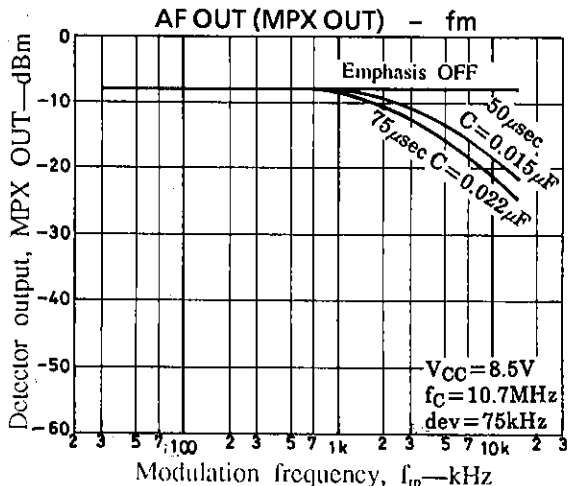
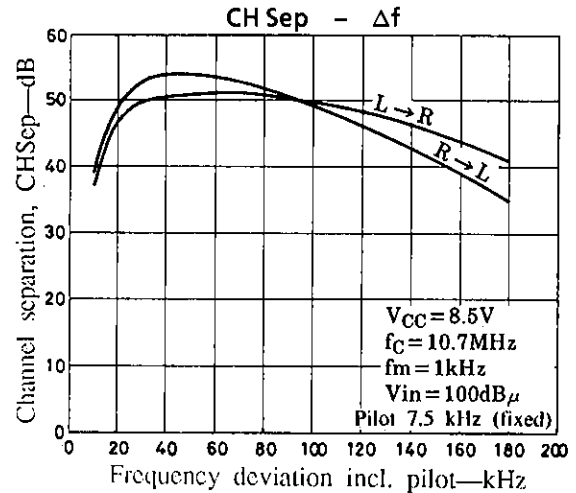
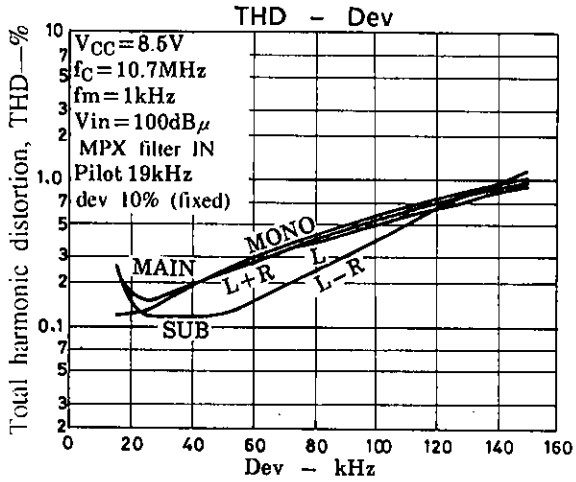
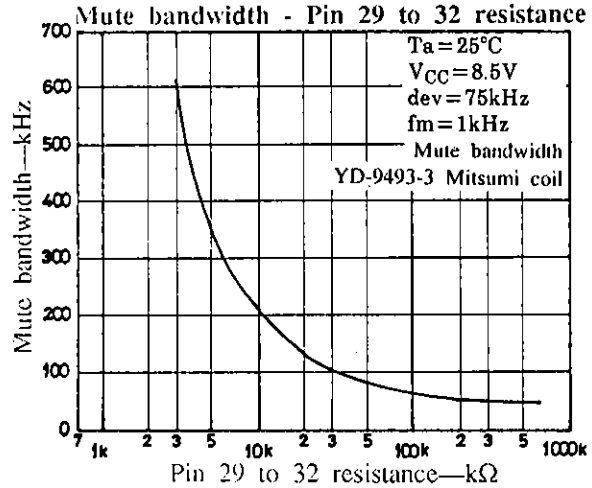
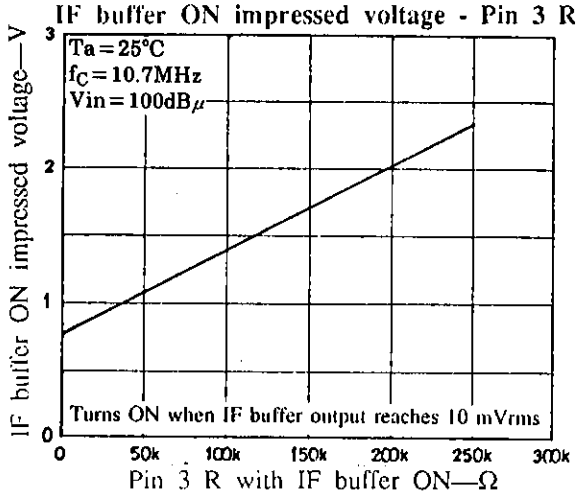
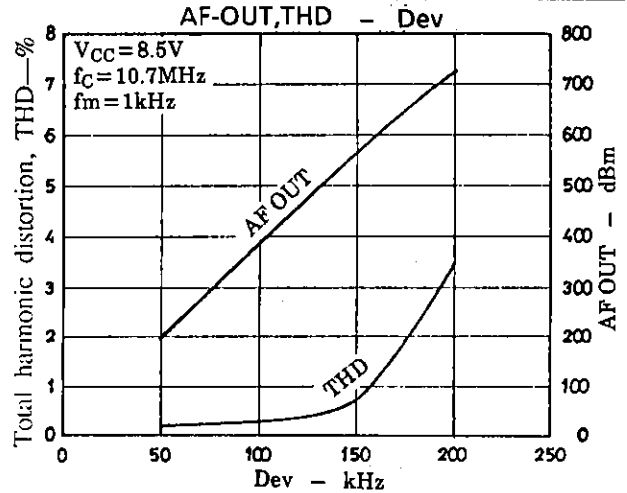
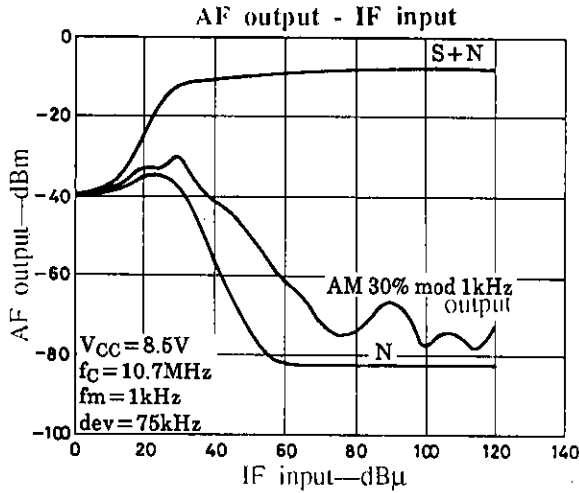

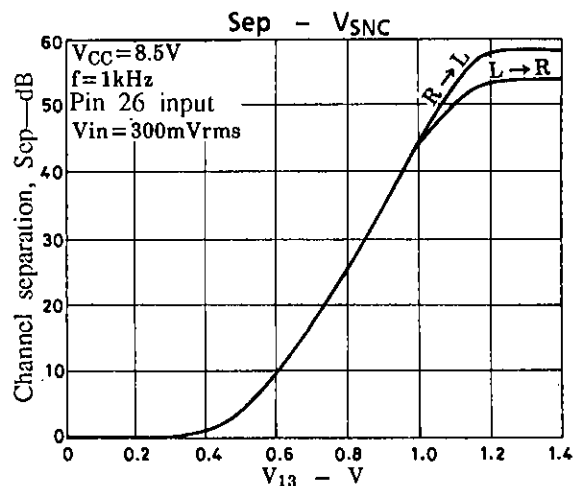
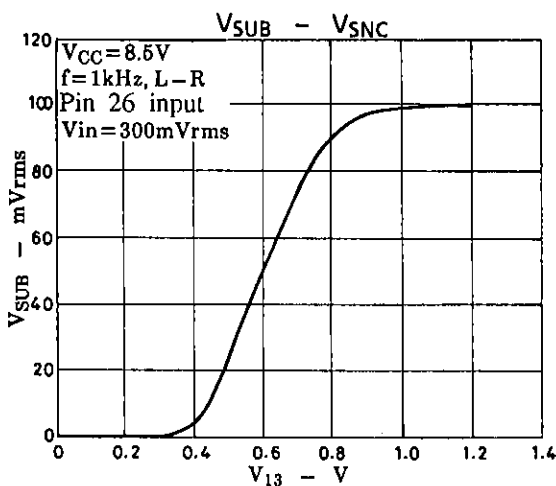
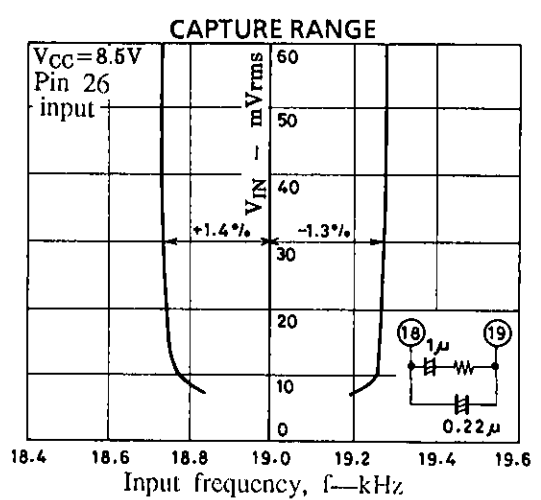
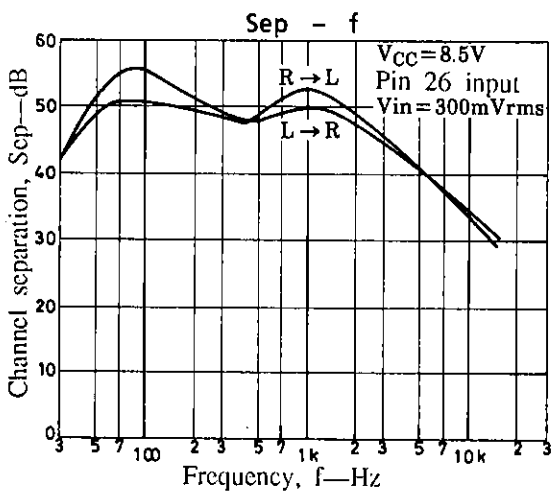
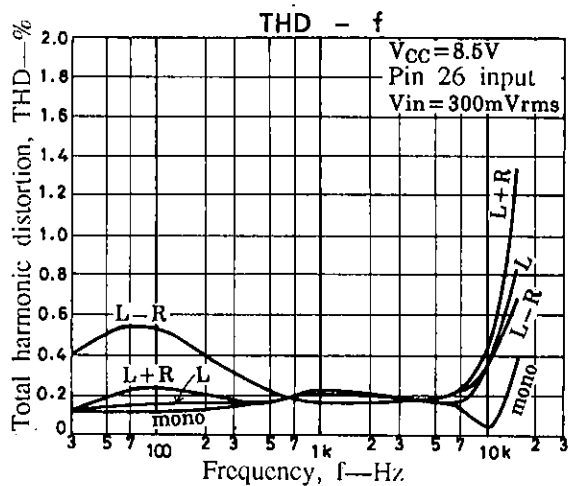
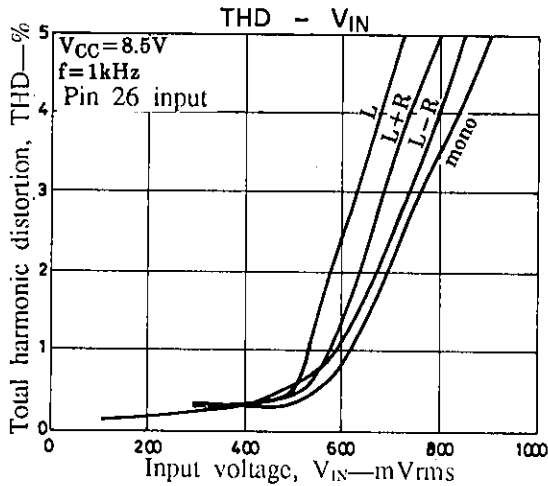
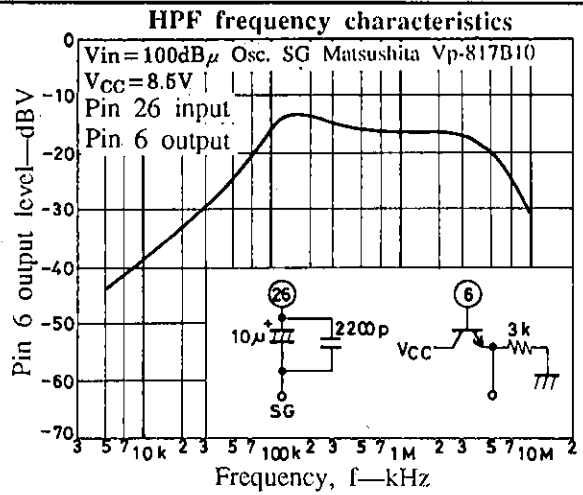
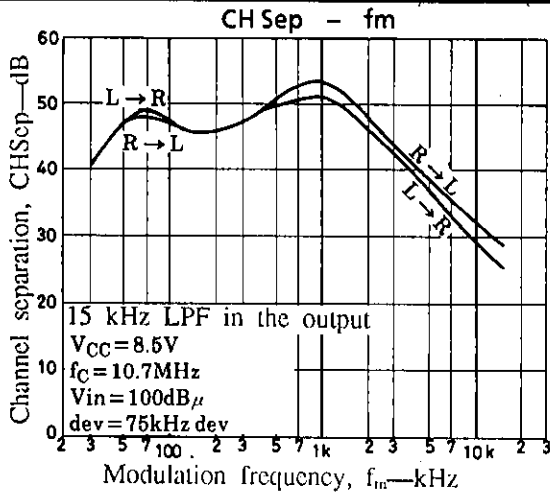

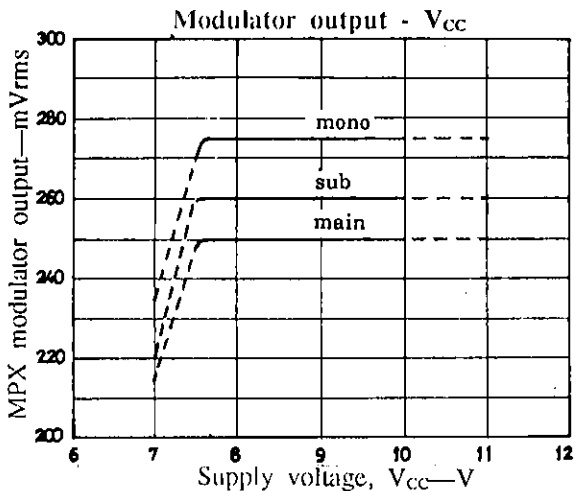
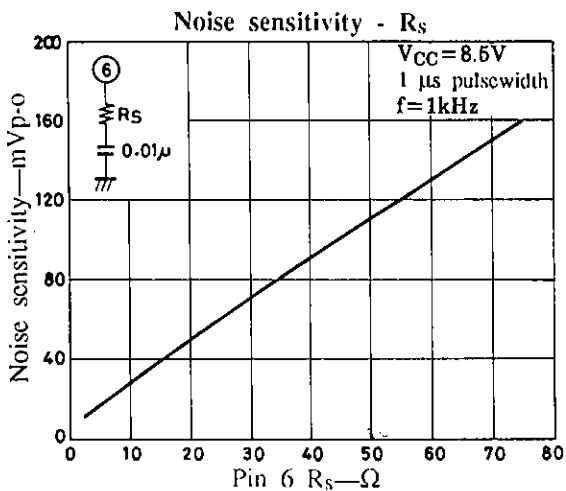
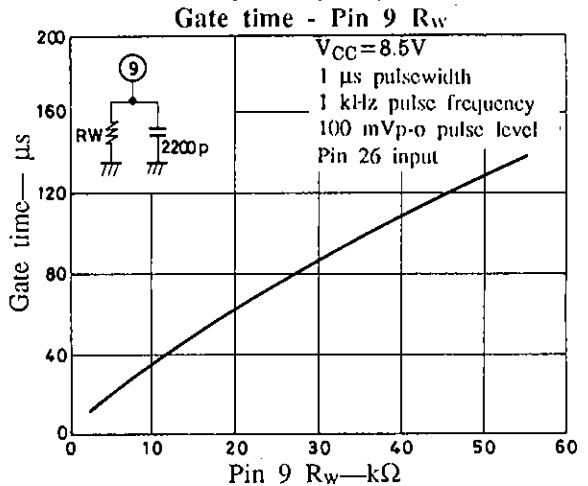
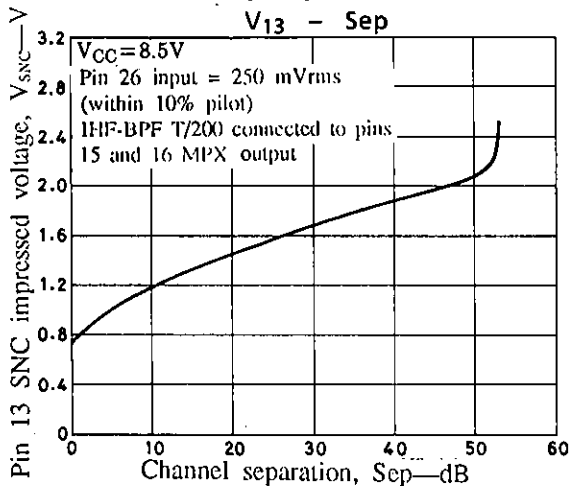
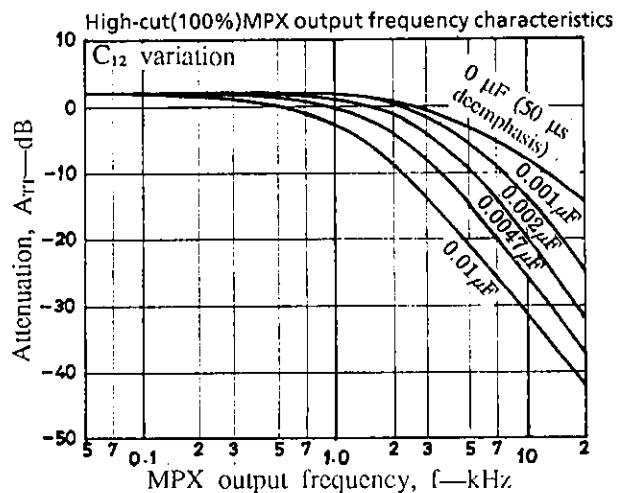
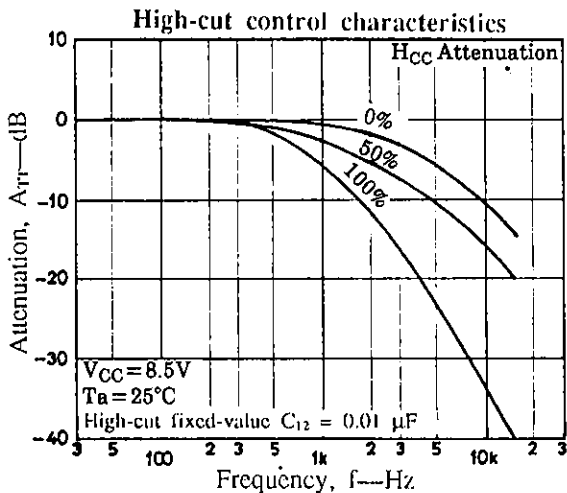
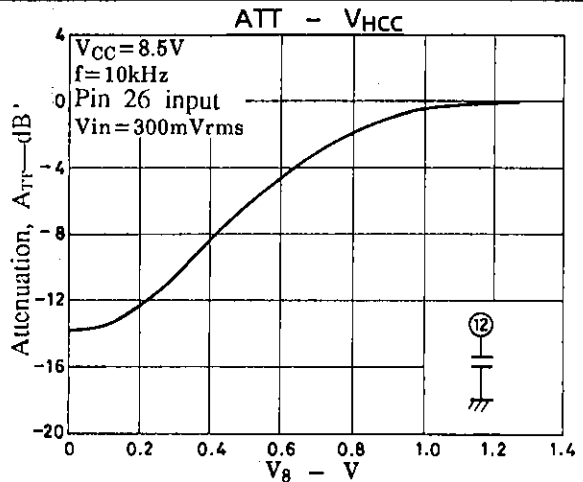
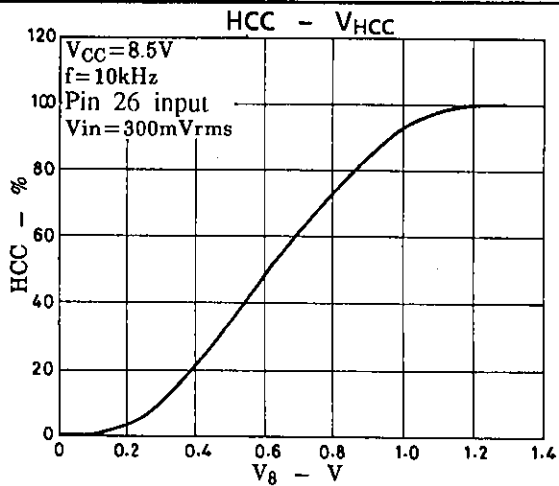

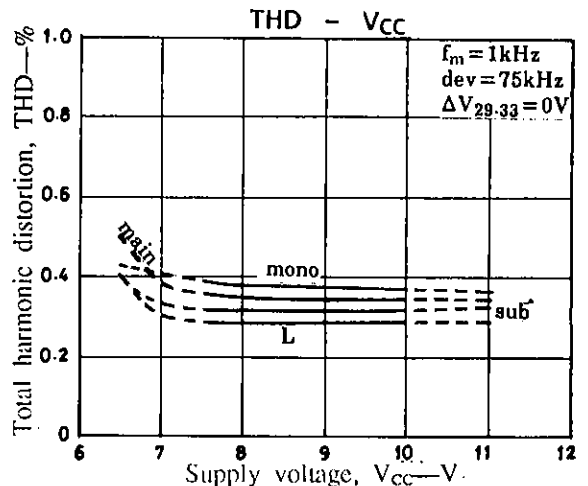
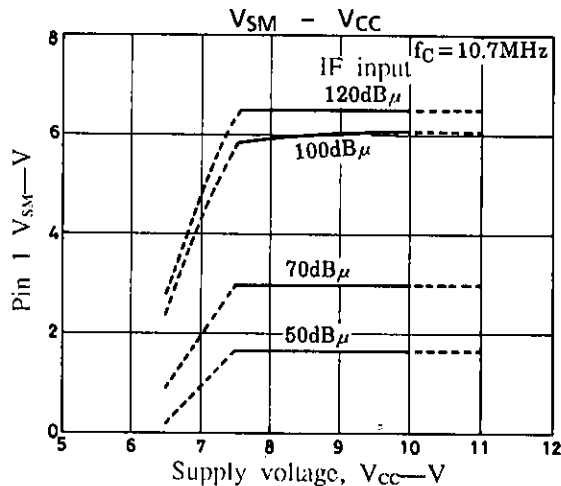
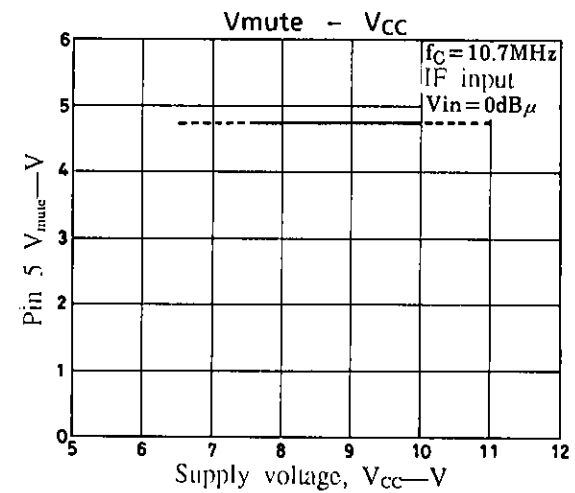
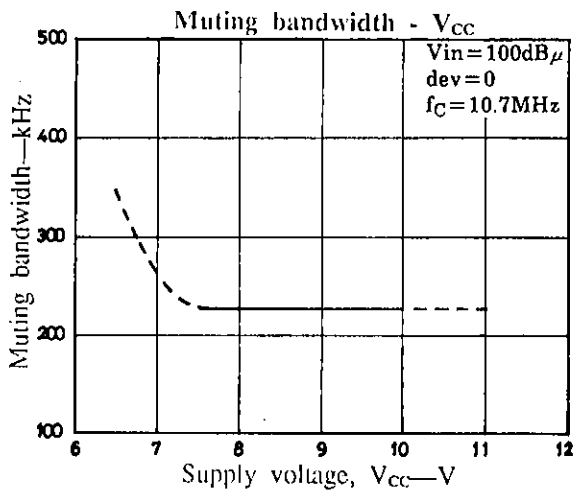
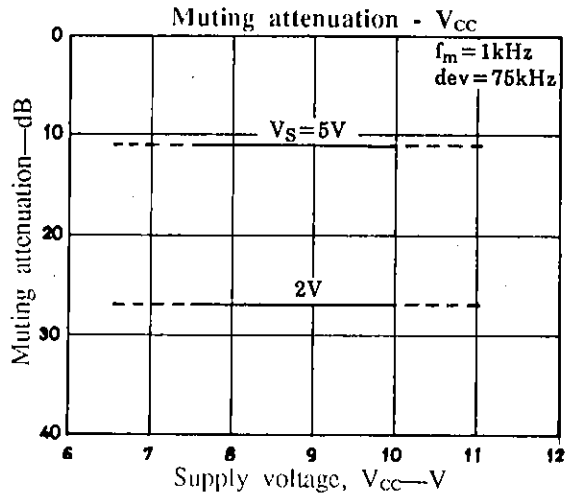
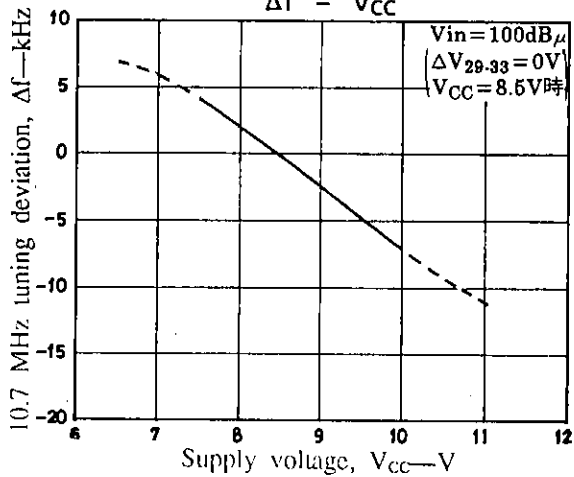
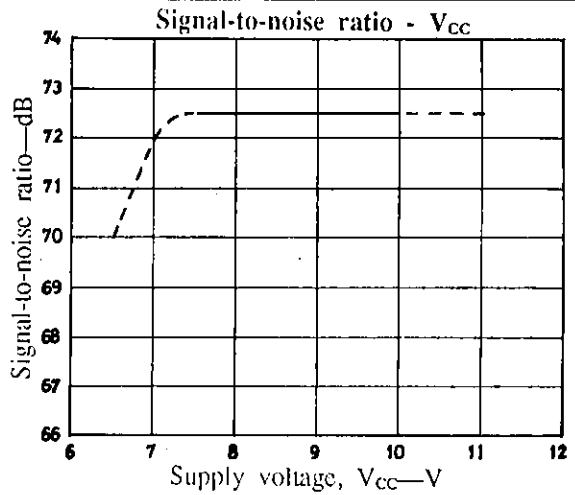
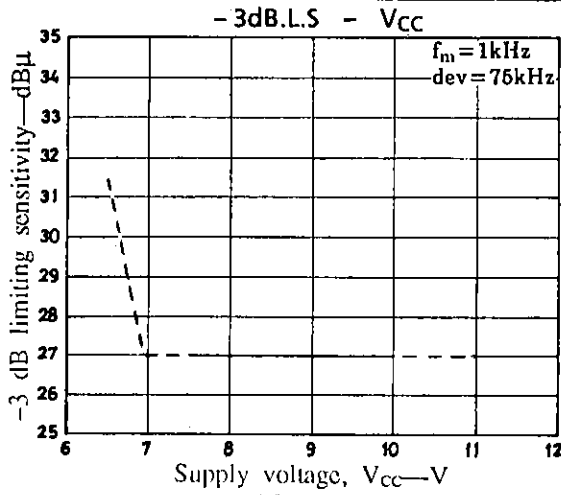

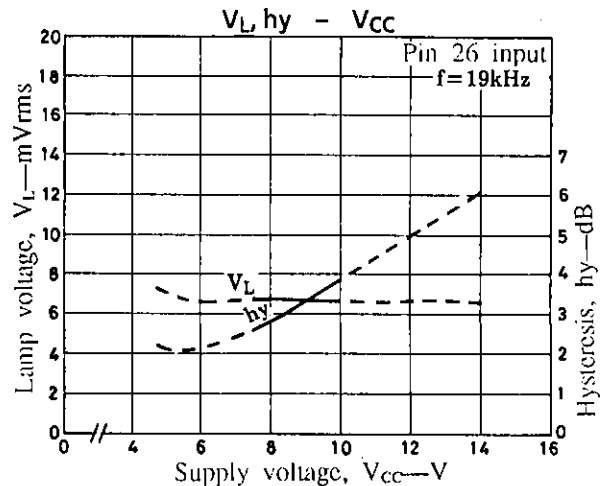
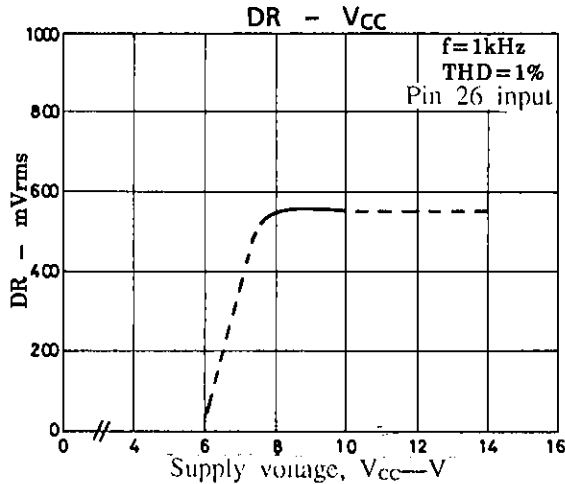
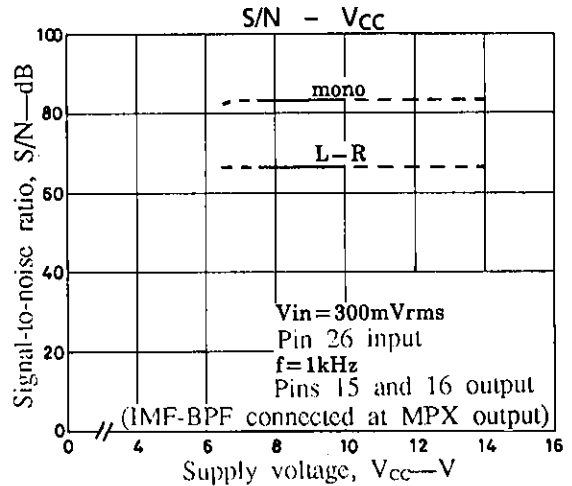
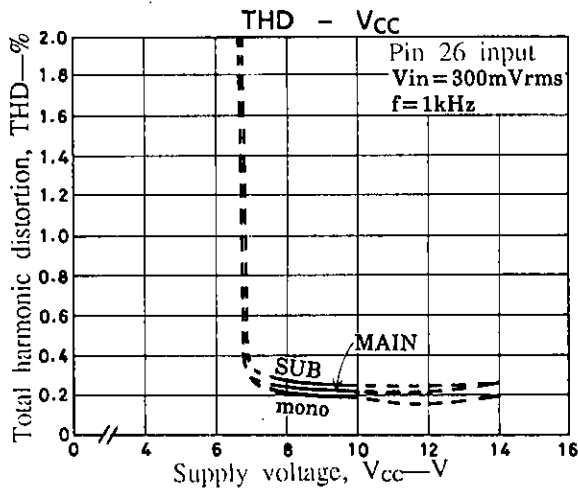
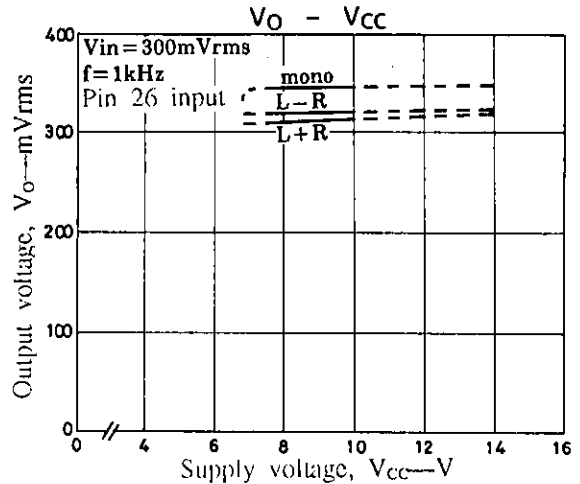
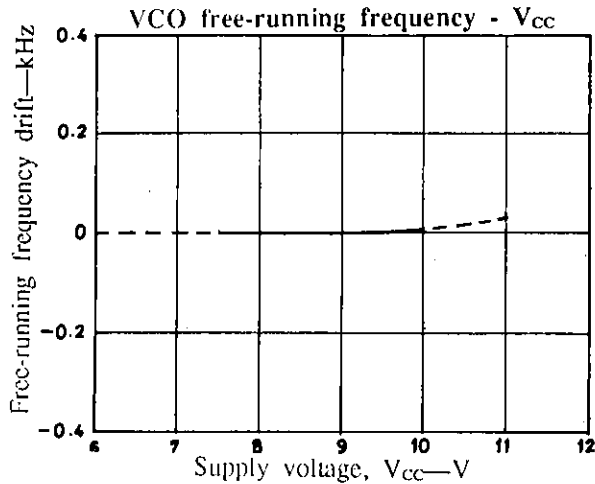
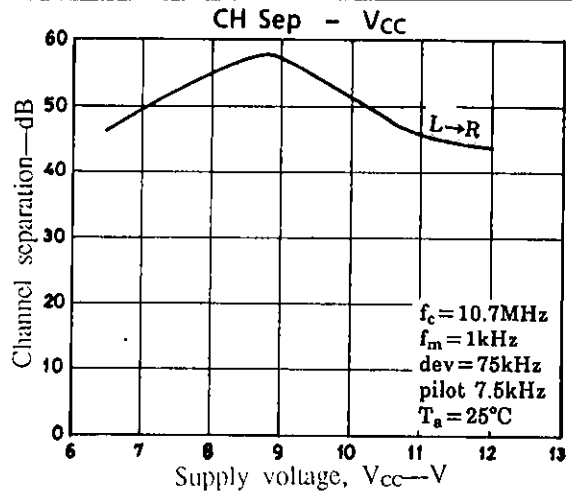
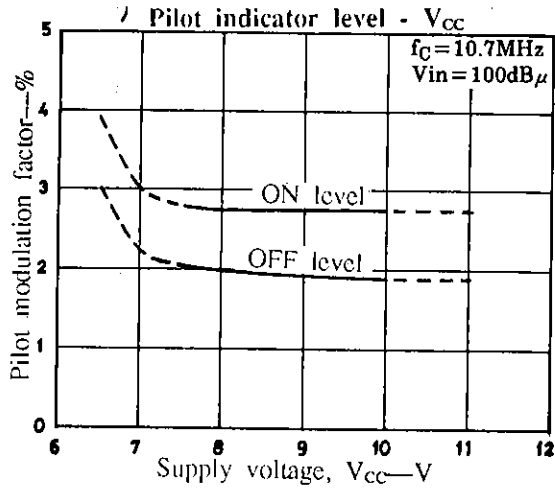



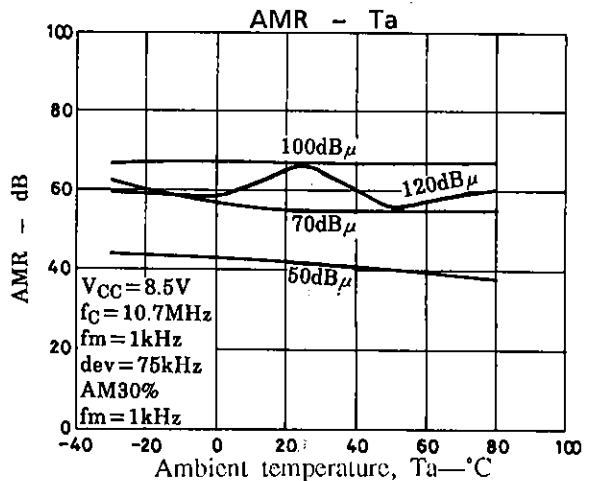
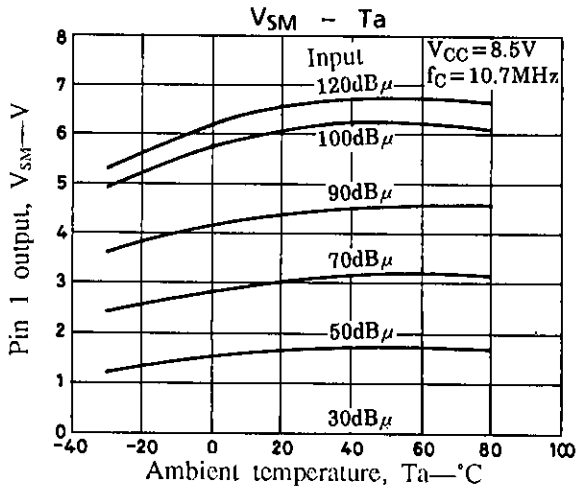
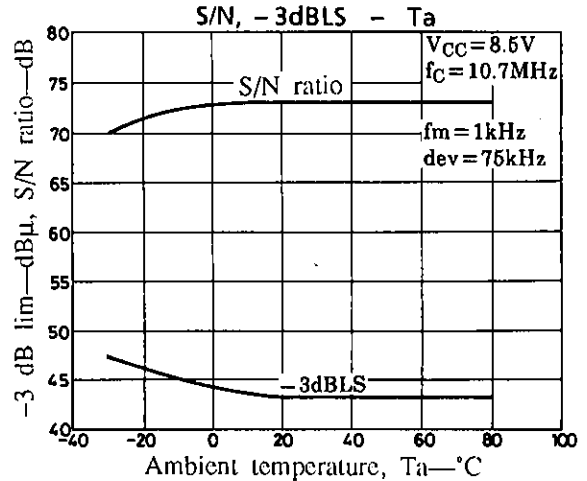
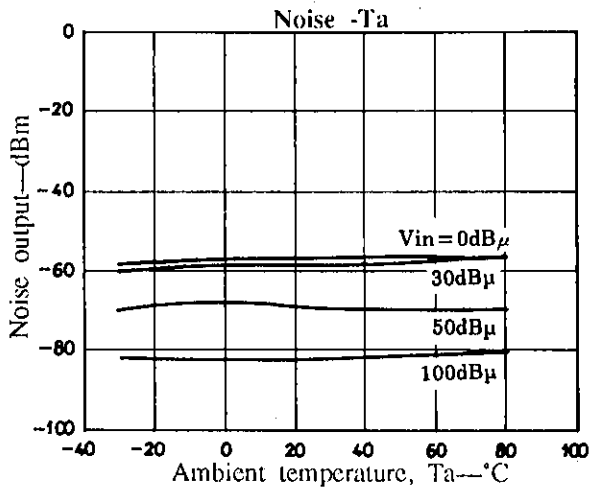
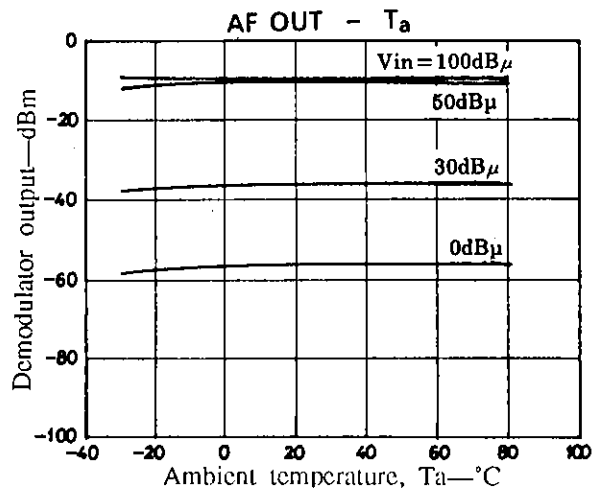
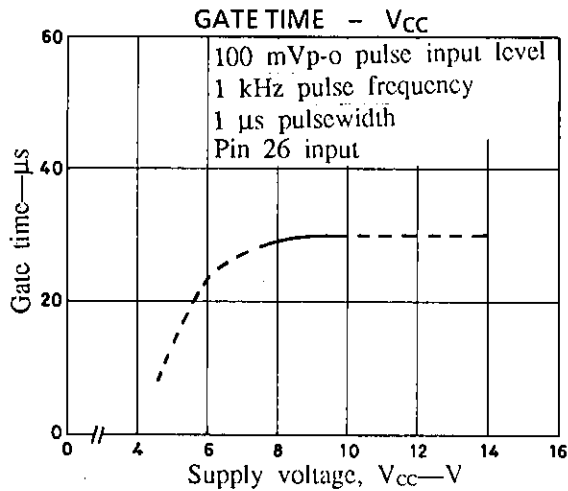
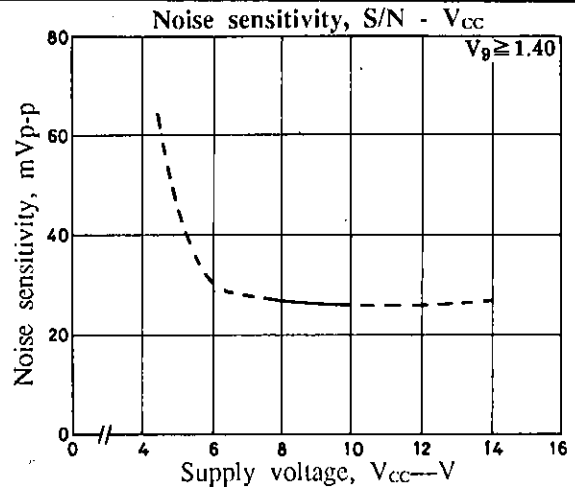
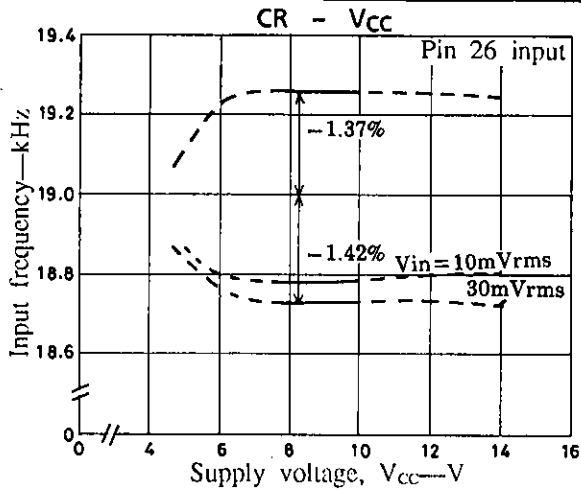

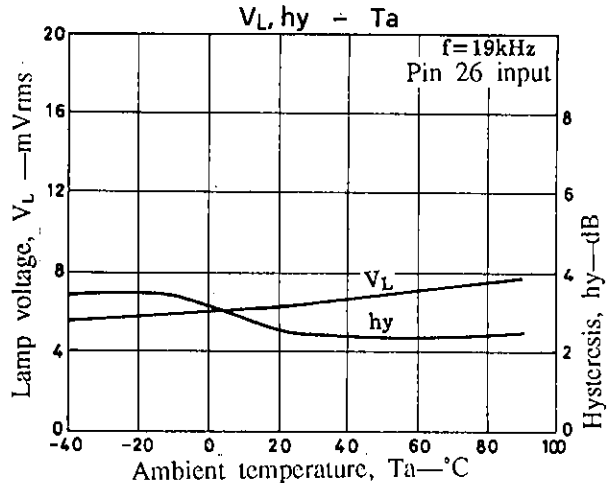
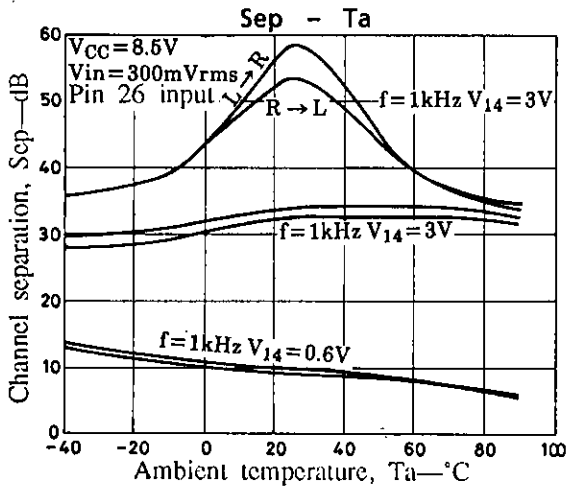
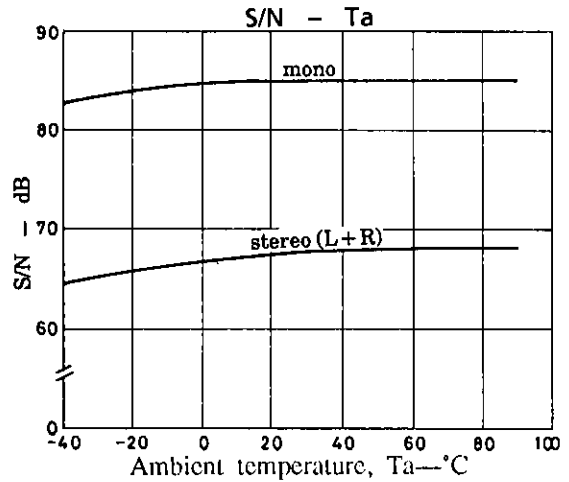
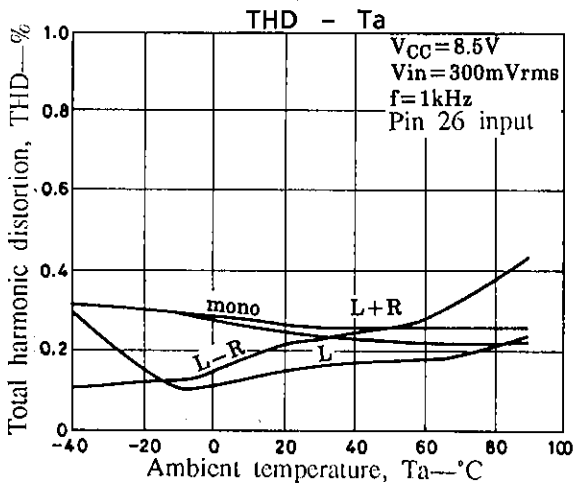
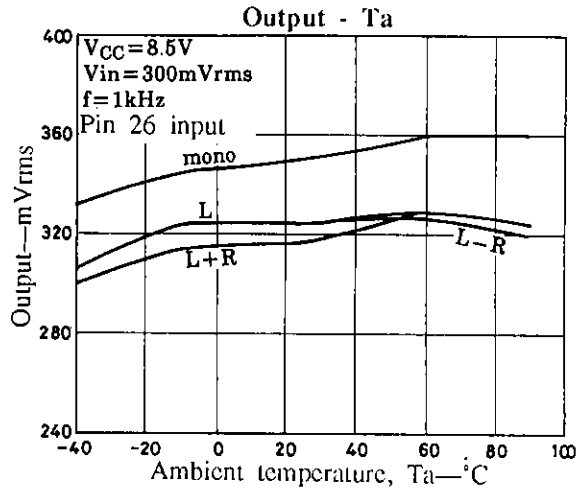
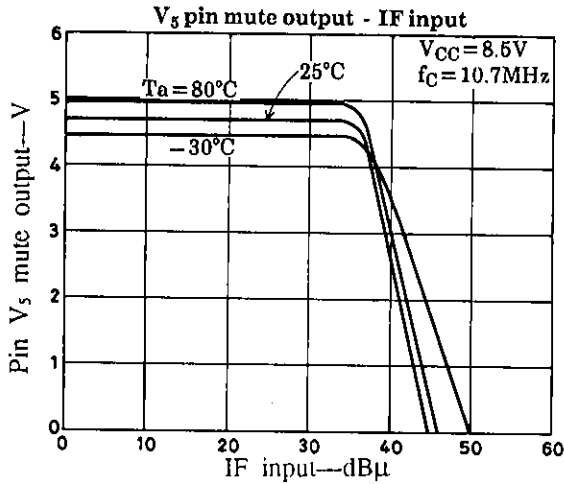
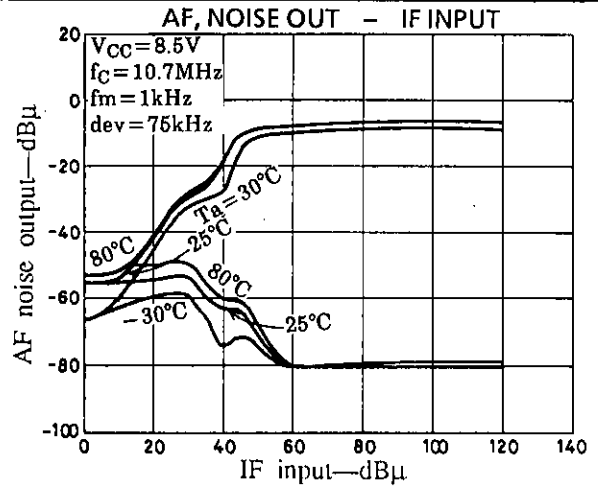
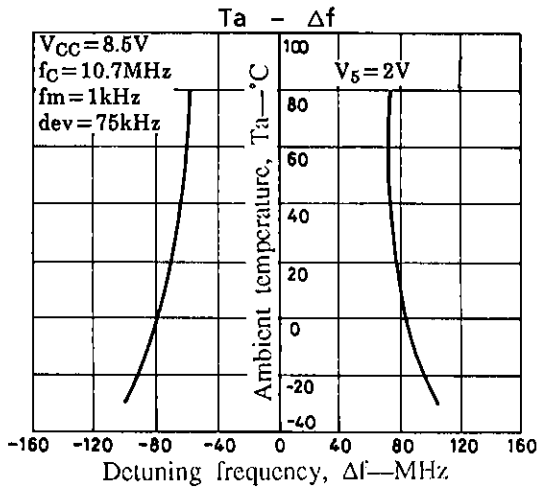

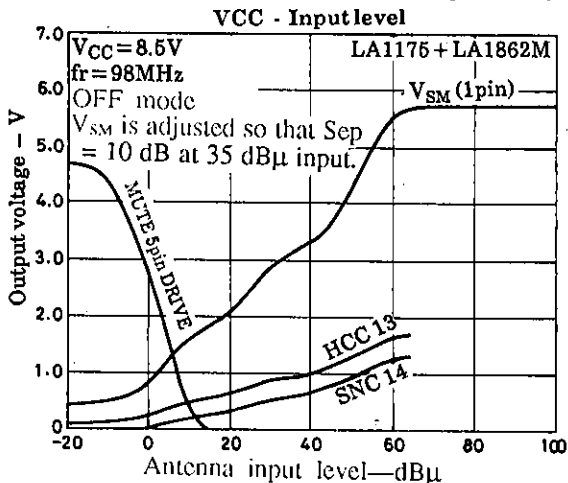
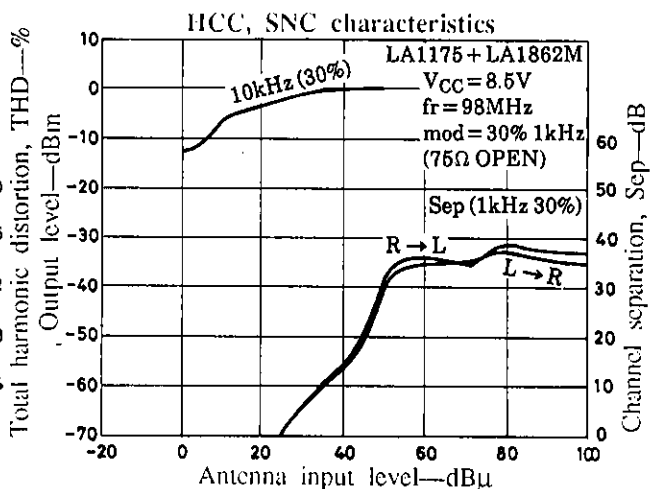
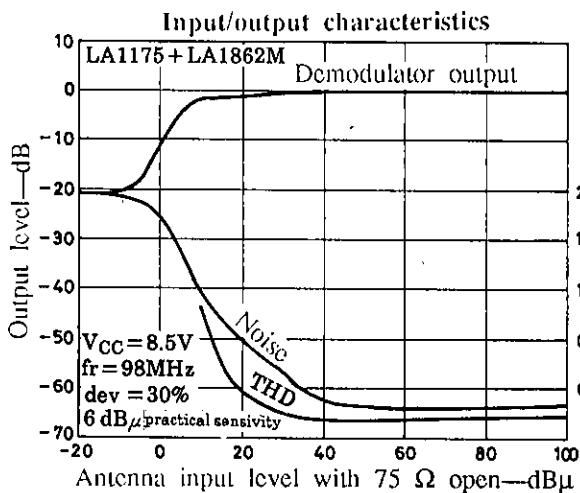
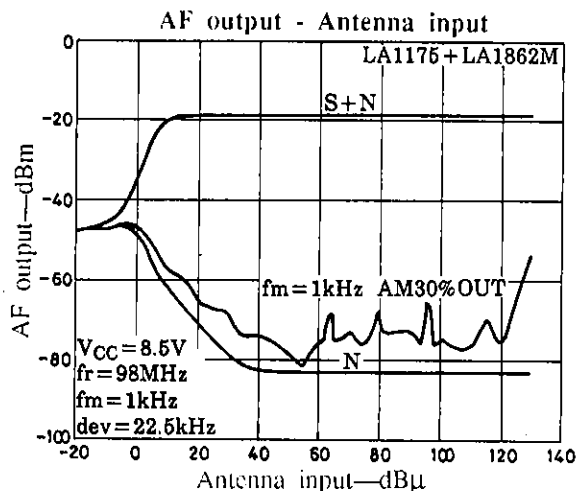
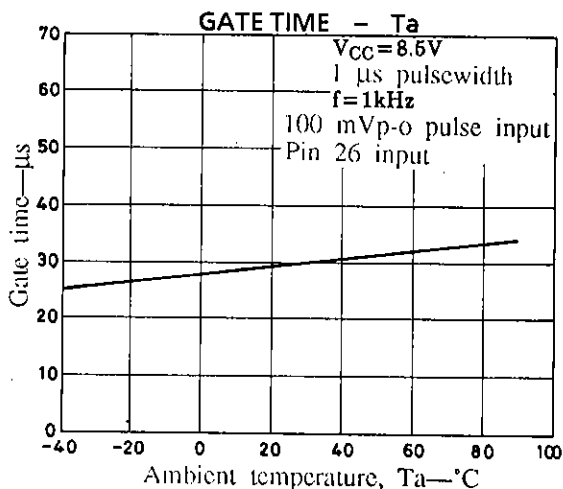
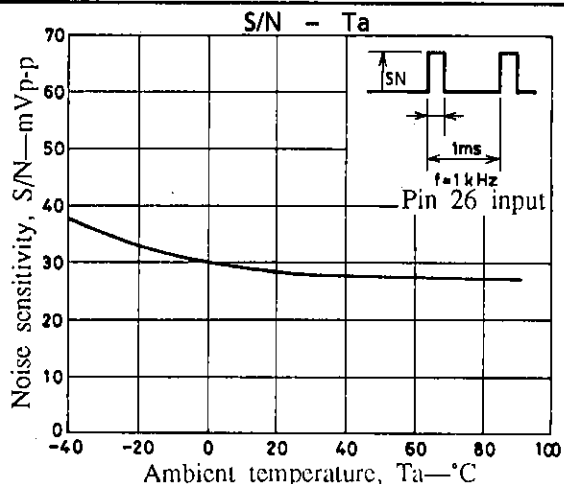
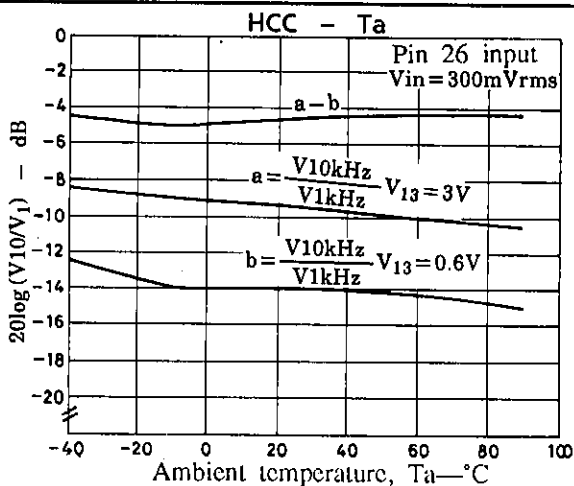

- No products described or contained herein are intended for use in surgical implants, life-support systems, aerospace equipment, nuclear power control systems, vehicles, disaster/crime-prevention equipment and the like, the failure of which may directly or indirectly cause injury, death or property loss.
- Anyone purchasing any products described or contained herein for an above-mentioned use shall:
  - ① Accept full responsibility and indemnify and defend SANYO ELECTRIC CO., LTD., its affiliates, subsidiaries and distributors and all their officers and employees, jointly and severally, against any and all claims and litigation and all damages, cost and expenses associated with such use:
  - ② Not impose any responsibility for any fault or negligence which may be cited in any such claim or litigation on SANYO ELECTRIC CO., LTD., its affiliates, subsidiaries and distributors or any of their officers and employees jointly or severally.
- Information (including circuit diagrams and circuit parameters) herein is for example only; it is not guaranteed for volume production. SANYO believes information herein is accurate and reliable, but no guarantees are made or implied regarding its use or any infringements of intellectual property rights or other rights of third parties.