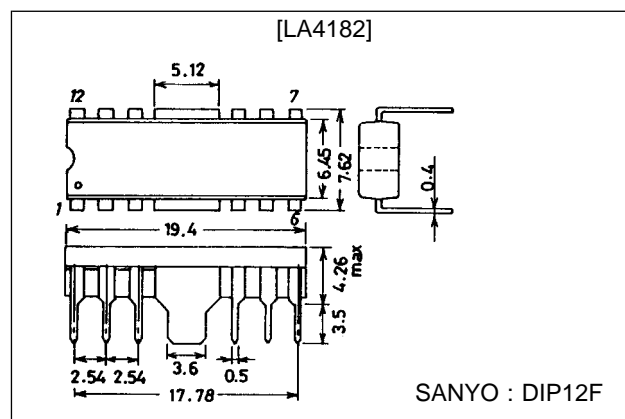

SANYO**LA4182****2.3 W 2-Channel AF Power Amplifier****Features**

- Built-in 2 channels enabling use in stereo and bridge amplifier applications.
- High output: 2.3 W/channel, $V_{CC} = 9\text{ V}$, $R_L = 4\ \Omega$, and 4.7 W/bridge, $R_L = 8\ \Omega$.
- Minimum number of external parts required : 9 pcs. min. (Stereo/bridge).
- Small pop noise at the time of power supply ON/OFF due to built-in muting circuit.
- Good ripple rejection ratio due to built-in ripple filter.
- Soft tone at the time of output saturation.
- Good channel separation.
- Voltage gain fixed at 45 dB (Bridge: 51 dB). Variable voltage gain available with external resistor added.
- Easy to design radiator fin.

Package Dimensions

unit : mm

3022A-DIP12F

Note) In general applications, heat generated in this package can be radiated through the Cu-foiled area of the printed circuit board, but since power dissipation P_d may be increased depending on the supply voltage and load conditions, it is recommended to use a fin additionally.

Specifications**Maximum Ratings at $T_a = 25^\circ\text{C}$**

Parameter	Symbol	Conditions	Ratings	Unit
Maximum supply voltage	$V_{CC\text{ max}}$	With signal	11	V
		Quiescent	15	V
Allowable power dissipation	$P_d\text{ max}$	With printed circuit board (Refer to P_d - T_a characteristics)	4	W
Operating temperature	T_{opr}		-20 to +75	$^\circ\text{C}$
Storage temperature	T_{stg}		-55 to +150	$^\circ\text{C}$

Recommended Operating Conditions at $T_a = 25^\circ\text{C}$

Parameter	Symbol	Conditions	Ratings	Unit
Supply voltage	V_{CC}		9	V
Load resistance	R_L	Stereo	4 to 8	Ω
		Bridge	8	Ω

LA4182

Operating Characteristics at $T_a = 25^\circ\text{C}$, $V_{CC} = 9\text{ V}$, $f = 1\text{ kHz}$, $R_L = 4\ \Omega$, $R_g = 600\ \Omega$, (): $8\ \Omega$,
See specified Test Circuit.

Parameter	Symbol	Conditions	min	typ	max	Unit
Quiescent current	I_{CCO}	Stereo Stereo		40	55	mA
Voltage gain	VG	Closed loop, $V_{IN} = -45\text{ dB}$ Stereo	43	45	47	dB
		Closed loop, $V_{IN} = -45\text{ dB}$ Bridge	49	51	53	dB
Voltage gain difference	ΔVG	Stereo			± 1	dB
Output power	P_O	THD = 10% Stereo	1.7	2.3 (1.3)		W
		THD = 10% Bridge		(4.7)		W
Total harmonic distortion	THD	$P_O = 250\text{ mW}$ Stereo		0.3	1.5	%
		$P_O = 250\text{ mW}$ Bridge		0.5		%
Input resistance	r_i		21	30		k Ω
Output noise voltage	V_{NO}	$R_g = 0$ Stereo		0.3	1.0	mV
		$R_g = 10\text{ k}\Omega$ Stereo		0.5	2.0	mV
Ripple rejection ratio	R_r	$R_g = 0$, $V_R = 150\text{ mV}$ Stereo	40	46		dB
Channel separation	CHsep	$R_g = 10\text{ k}\Omega$, $V_O = 0\text{ dB}$ Stereo	40	55		dB

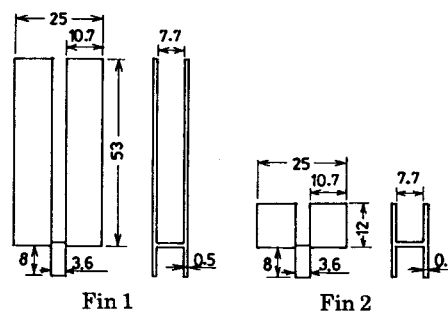
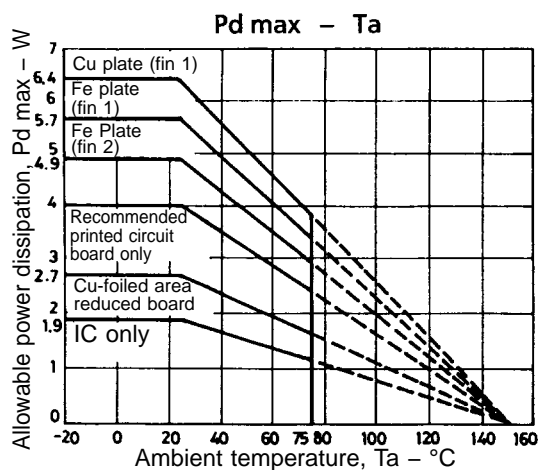

Pin Assignment and Equivalent Circuit

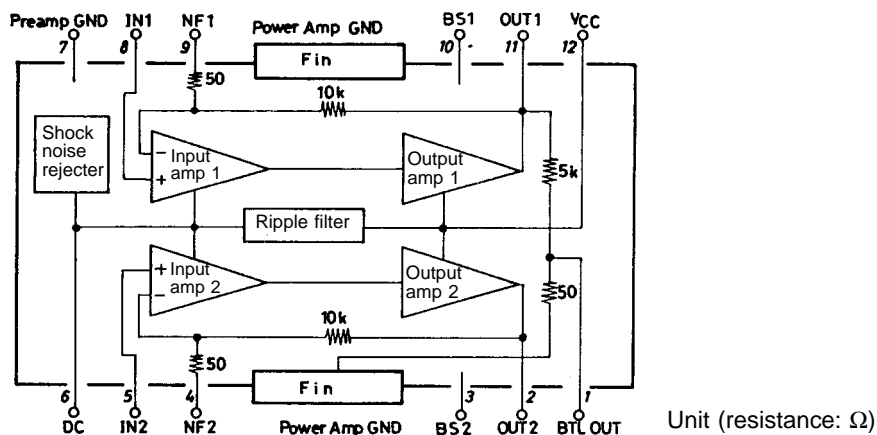

LA4182

Sample Application Circuit 1 : Stereo

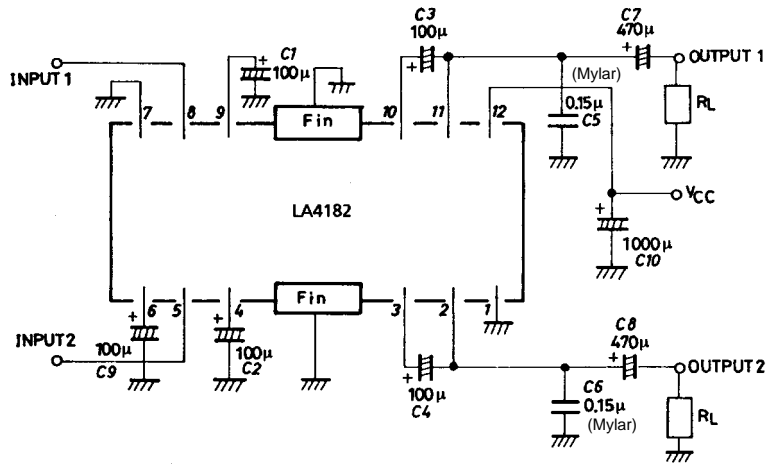

Unit (capacitance: F)

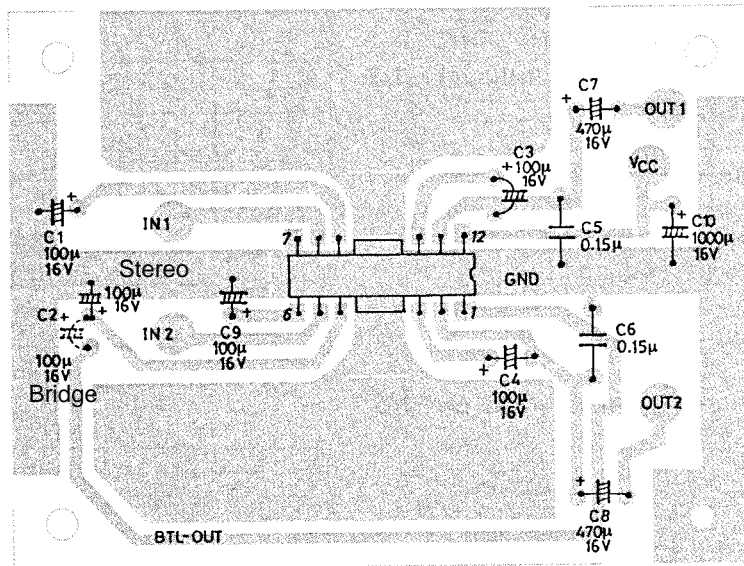

Unit (capacitance: F)

Example of printed pattern (bottom view) for use in stereo, bridge amplifier applications : 60 × 80 mm²

Sample Application Circuit 2 : Bridge

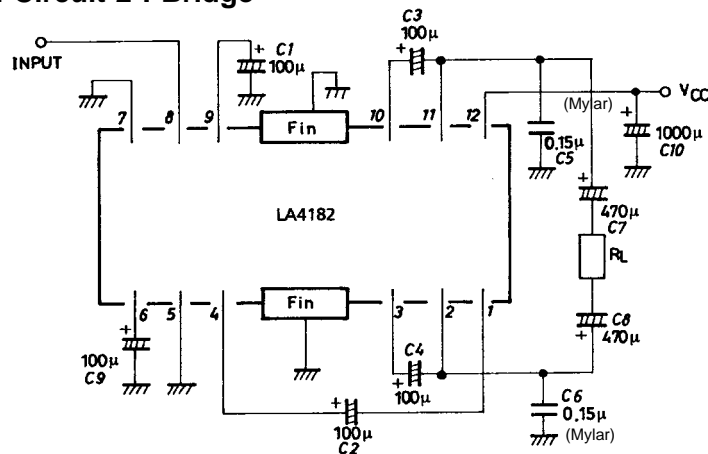

Unit (capacitance: F)

Description of External Parts

C1(C2)	Feedback capacitor	The low cutoff frequency depends on this capacitor. If the capacity is increased, the starting time is delayed.
C3(C4)	Bootstrap capacitor	If the capacity is decreased, the output at low frequencies goes lower.
C5(C6)	Oscillation preventing capacitor	Polyester film capacitor, being good in temperature characteristic, frequency characteristic, is used. If an aluminum electrolytic capacitor or ceramic capacitor is used, oscillation may occur at low temperatures.
C7(C8)	Output capacitor	The low cutoff frequency depends on this capacitor. In order for the low frequency characteristic in the bridge amplifier to be equal to that in the stereo amplifier application, the capacity must be doubled.
C9	Decoupling capacitor	Used for the ripple filter. Since the rejection effect is saturated at a certain capacity, it is meaningless to increase the capacity more than needed. This capacitor, being also used for the time constant of the muting circuit, affects the starting time.
C10	Power source capacitor	

Application Circuit

1. Voltage gain adjustment

◆ Stereo

The voltage gain depends on built-in resistors R1 (R2), R3 (R4) as follows :

$$VG = 20\log \frac{R3 (R4)}{R1 (R2)} \text{ [dB]}$$

If the IC is used at a voltage gain less than this, the following equation with Rf added applies.

$$VG = 20\log \frac{R3 (R4)}{R1 (R2) + Rf} \text{ [dB]}$$

where R1 (R2) = 50 Ω, R3 (R4) = 10 kΩ

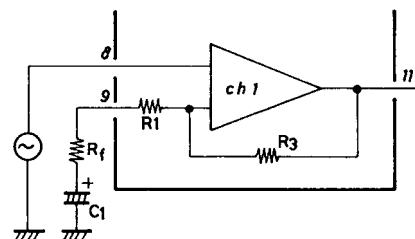

◆ Bridge

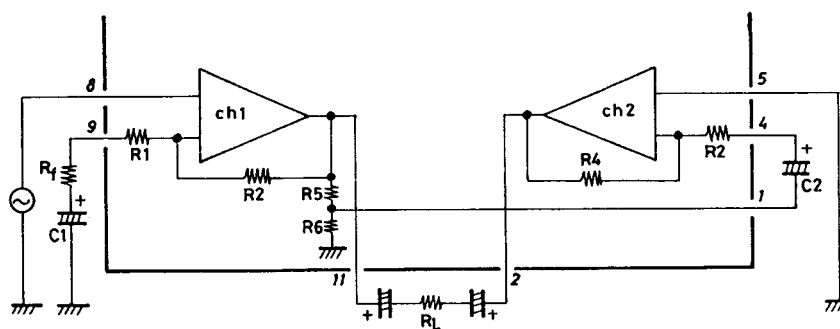

The above shows the bridge amplifier configuration, where ch.1 operates as a noninverting amplifier and ch.2 as an inverting amplifier. The output of ch.1 is divided with R5, R6 and led to pin 1 and then input to ch.2.

Since the attenuation degree (R5/R6) of ch. 1 output and the amplification degree (R4/R2 + R6) of ch. 2 are fixed at an equal value, the ch.2 output is in opposite phase with the ch. 1 output. Therefore, the total voltage gain gets apparently 6 dB higher than the voltage gain of ch.1 alone and is determined by the following equation.

$$VG = 20\log \frac{R3}{R1} + 6 \text{ [dB]}$$

If the IC is used at a voltage gain less than this, the following equation with Rf added applies.

$$VG = 20\log \frac{R3}{R1 + Rf} + 6 \text{ [dB]}$$

2. Proper cares in using IC

- If the IC is used in the vicinity of the maximum rating, even a slight variation in conditions may cause the maximum rating to be exceeded, thereby leading to a breakdown. Allow an ample margin of variation for supply voltage, etc. and use the IC in the range where the maximum rating is not exceeded.
- Pin-to-pin short
If the supply voltage is applied when the space between pins is shorted, a breakdown or deterioration may occur. When mounting the IC on the board of applying the supply voltage, make sure that the space between pins is not shorted with solder, etc.
- Load short
If the IC is used with the load shorted for a long time, a breakdown or deterioration may occur. Be sure not to short the load.
- When the IC is used in radios or radio-cassette tape recorders, keep a good distance between IC and bar antenna.
- When making the board, refer to the example of printed circuit pattern.

Proper cares in operating a set with LA4182 incorporated

When a set with the LA4182 incorporated is operated from AC power supply, a momentary drop in supply voltage is caused by the transformer regulation, etc. at the time of turning ON the motor with the circuit shown below. In this case, if ripple noise is generated from the speaker or headphone, take the following actions.

1. Connect a diode (rectifier diode of average rectified current $I_O = 100$ to 200 mA) across pins 6 and 12 of the LA4182 so that the voltage at pin 6 can follow the supply voltage regulation. In the steady state, this diode is cut off.
2. Increase the capacity of the power source capacitor so that the supply voltage regulation can be minimized.

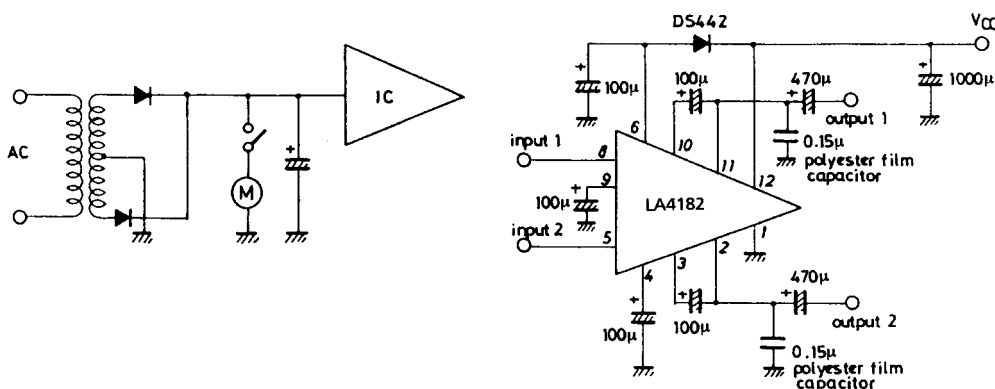

Unit (capacitance: F)

Radiation design

- Since the DIP 12-pin package is so designed as to be able to radiate heat through the Cu-foiled area of printed circuit board under normal operating conditions, make the Cu-foiled area near the fin of IC as large as possible when designing the printed circuit board.
- By providing the Cu-foiled area covered by the broken line as shown in the above-mentioned example of printed circuit pattern, a rather satisfactory radiation is enabled. (Refer to the Pd max-Ta characteristics.)
- Since the power dissipation (Pd) goes higher depending on the conditions of supply voltage and load, it is recommended to use a fin together with the printed circuit board.
- The following equations are rule-of-thumb guides for Pd (for stereo). For AC power supply, it is desirable to measure with the transformer of each individual set. In the bridge amplifier application, calculation should be made with 1/2 of the load used.

(1) DC power supply

$$Pd \max = \frac{V_{CC}^2}{\pi^2 R_L} + I_{CCO} \cdot V_{CC} \text{ (For stereo)}$$

(2) AC power supply

$$P_{d \max} = \frac{V_{CC} (Pd)^2}{\pi^2 R_L} + I_{CCO} \cdot V_{CC} (Pd) \text{ (For stereo)}$$

V_{CC2} : Quiescent supply voltage

$$V_{CC} (Pd) : \text{Supply voltage at max. output, } V_{CC} (Pd) = \frac{(1+r)V_{CC1}}{1 + \frac{r \cdot V_{CC1}}{\sqrt{2} \cdot \pi \cdot R_L} \times \sqrt{\frac{R_L}{P_{O \max}}}}$$

V_{CC1} : Supply voltage at max. output

r : Voltage regulation, $\frac{V_{CC2} - V_{CC1}}{V_{CC1}}$

I_{CCO} : Quiescent current

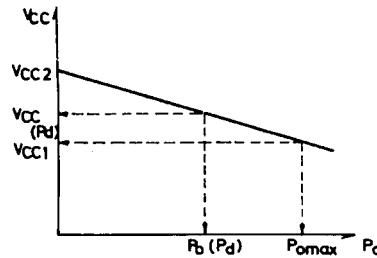

Example of fin mounting

The fin is formed into such a shape as to be able to radiate heat from the plastic fin area of IC and the fin as shown below and is soldered to the printed circuit board. For the fin size, refer to the $P_{d \max}$ - T_a characteristics. The desirable material is copper or iron which is solderable. It is recommended to apply silicone grease, etc. to the plastic area of IC in order to minimize the thermal resistance.

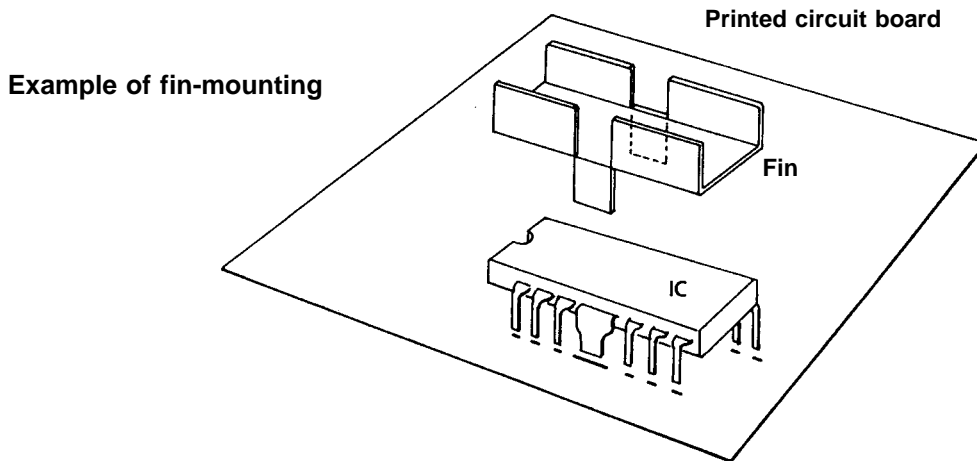

Example of fin-mounting

[Stereo Application]

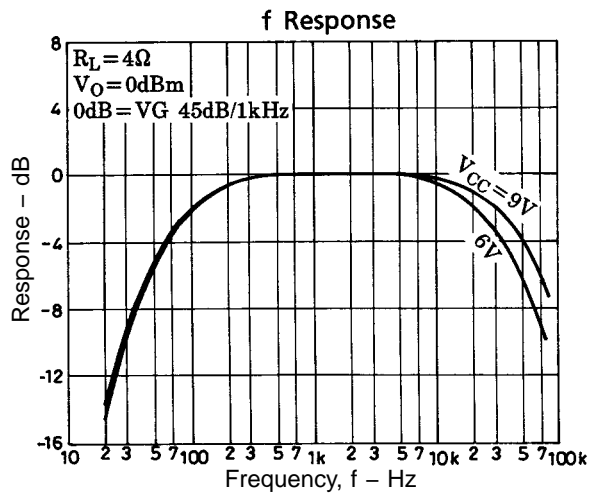
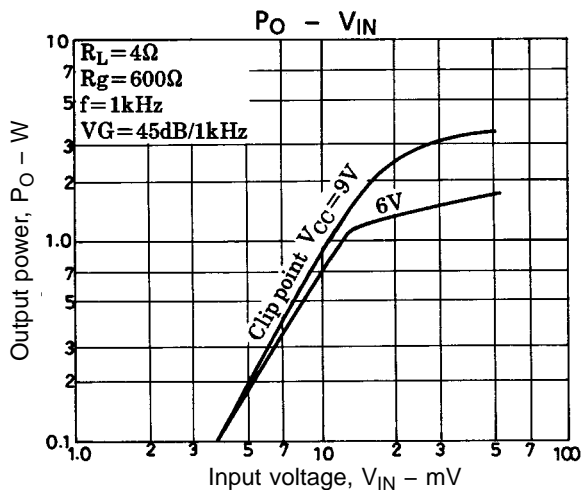

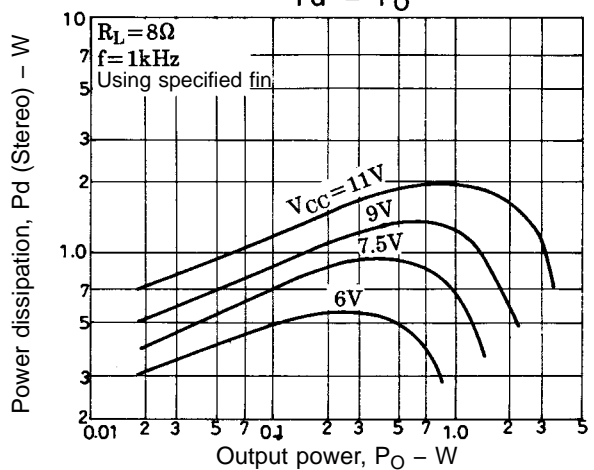
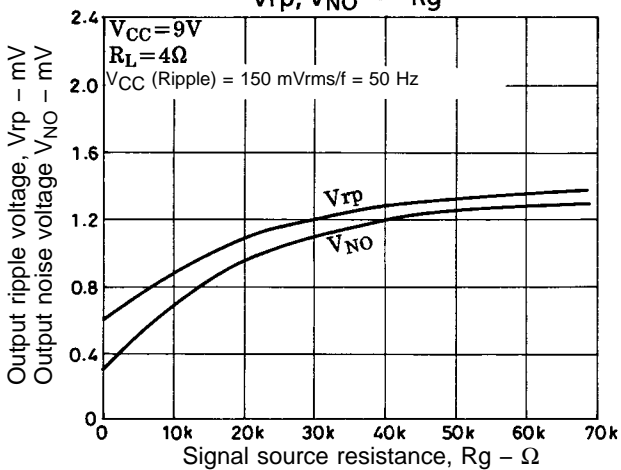
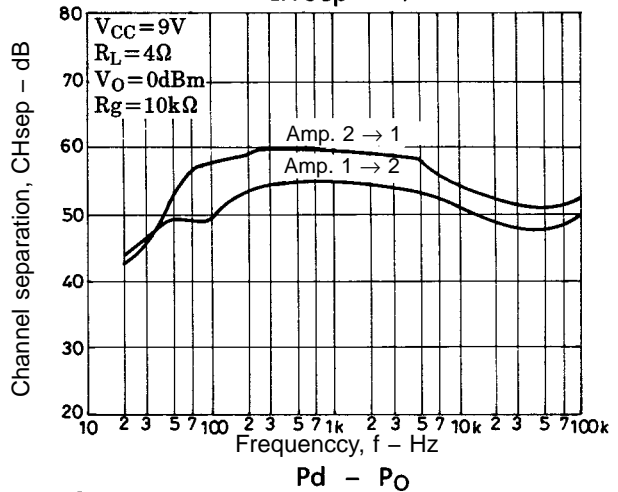
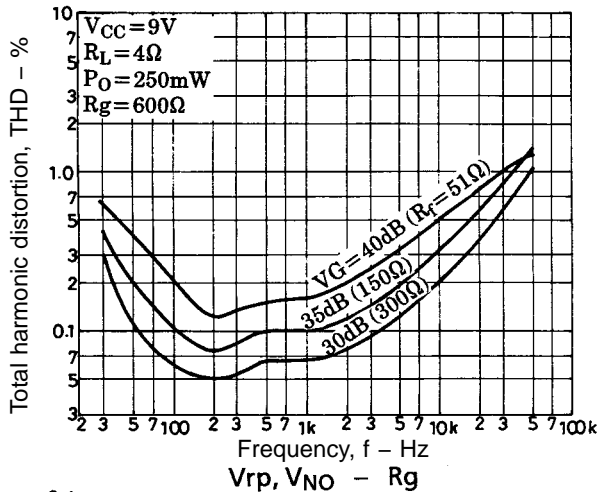
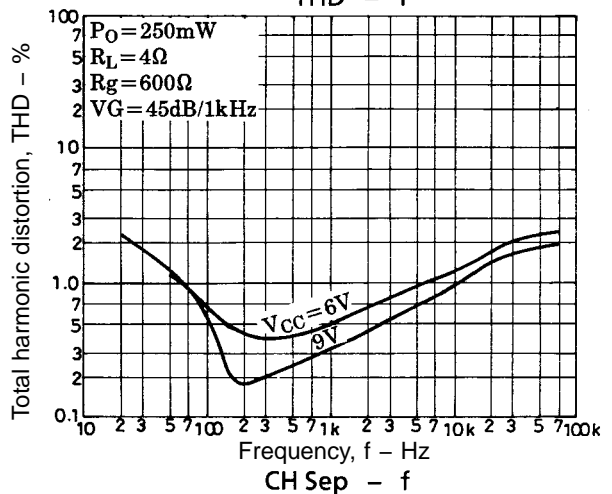
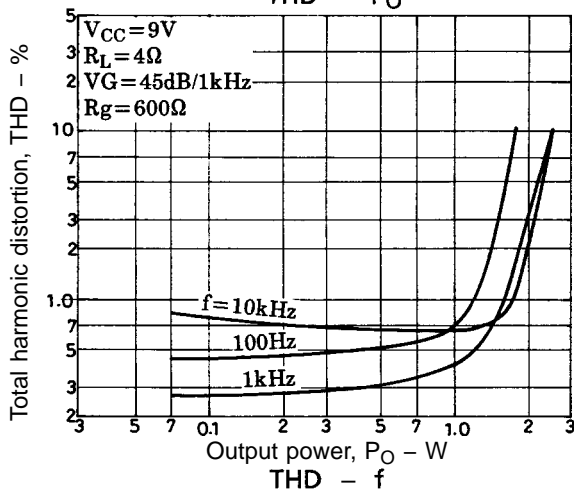
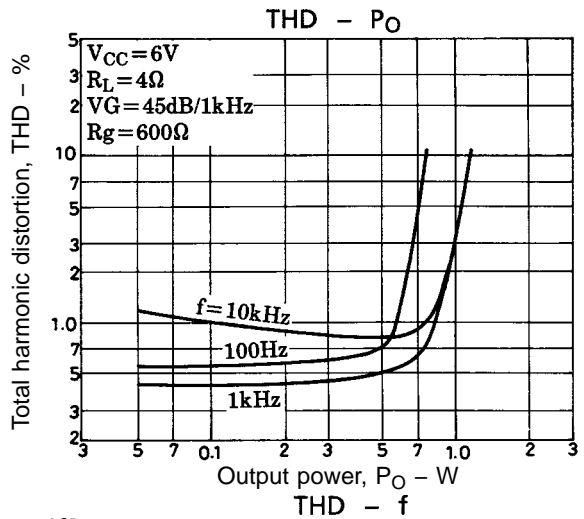
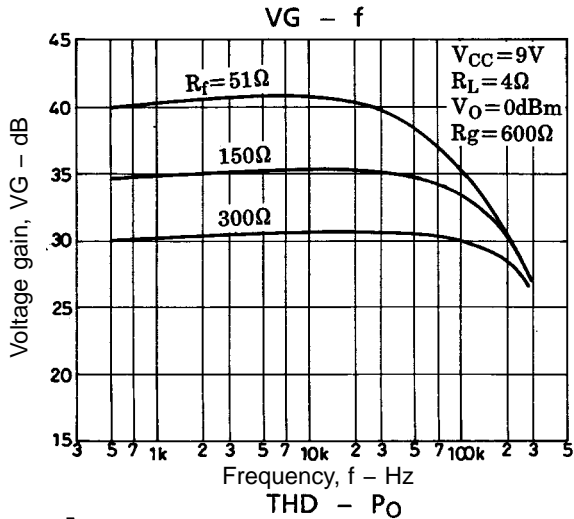

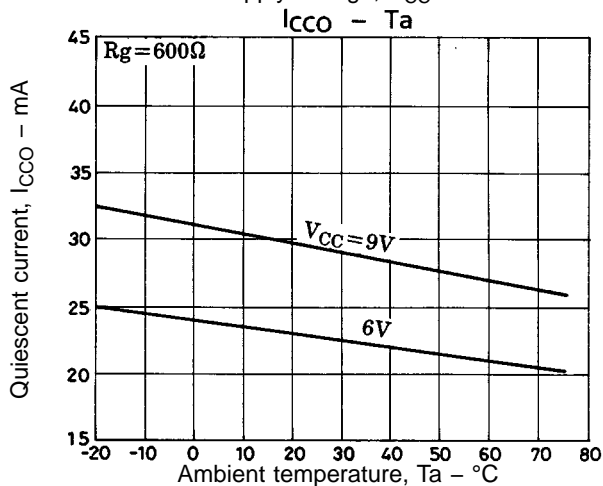
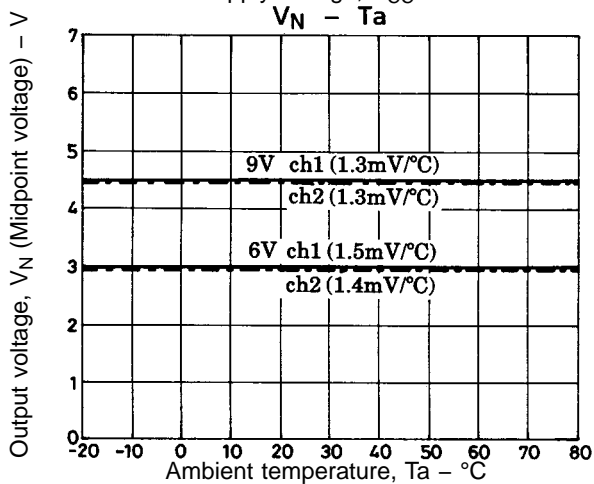
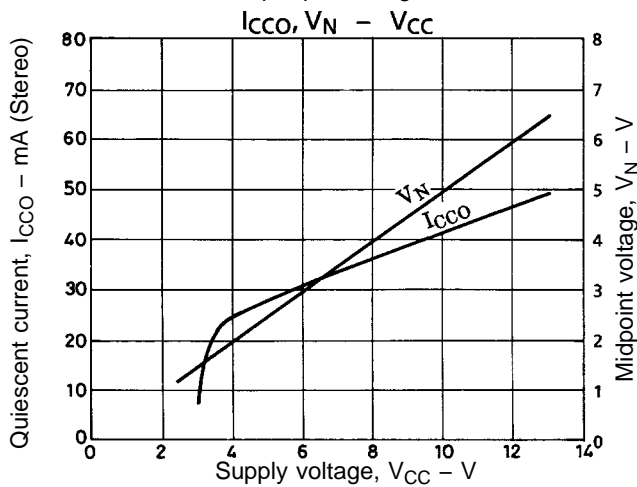
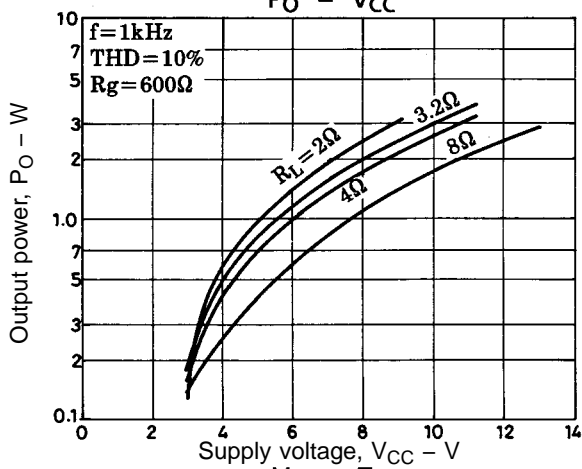
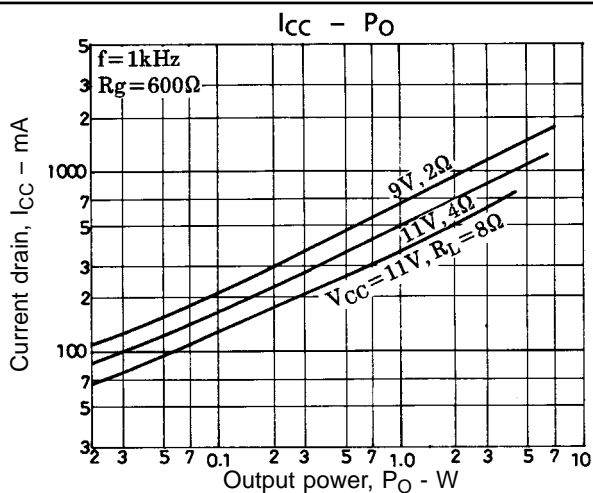
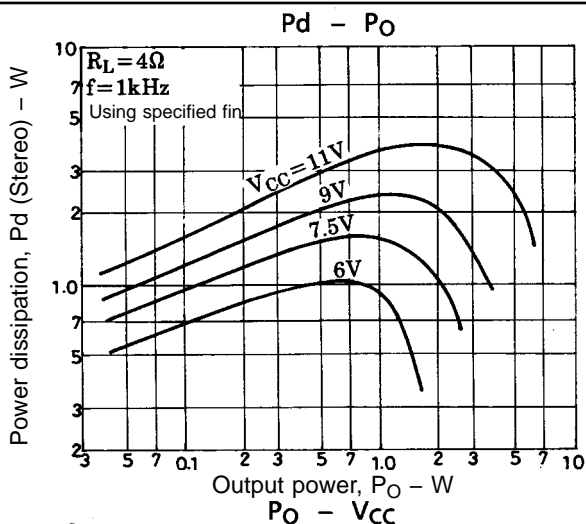

[Bridge Application]

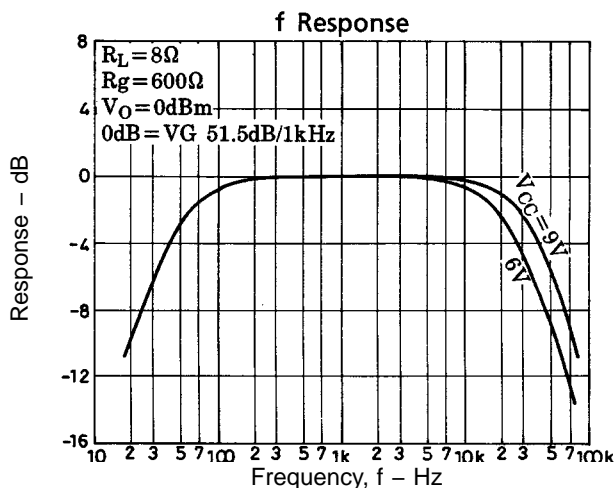
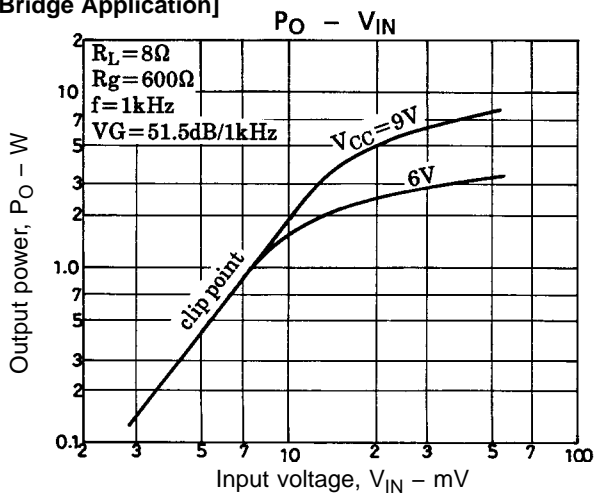

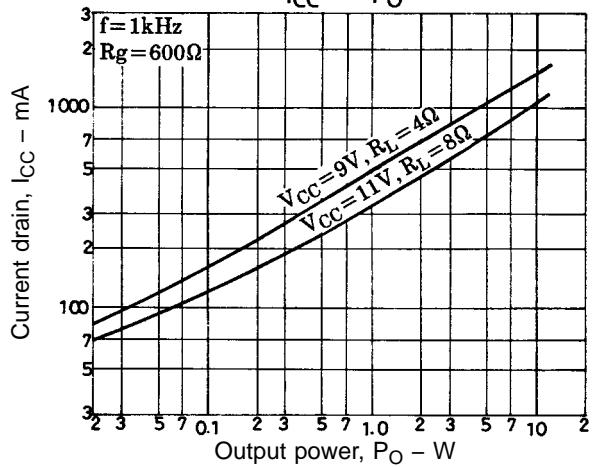
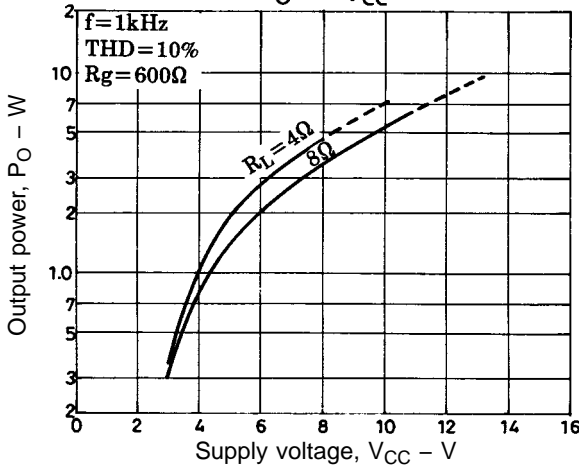
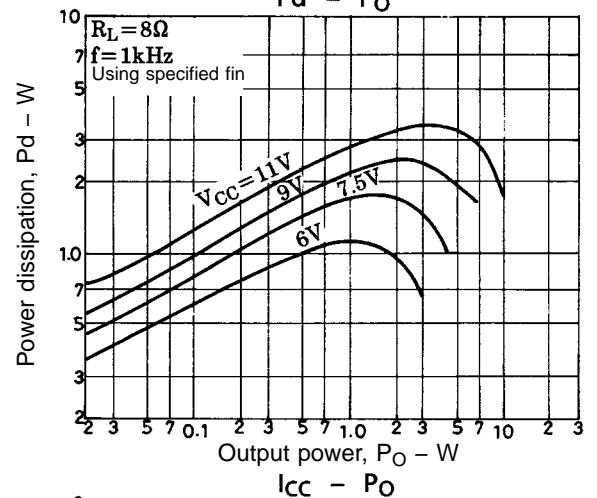
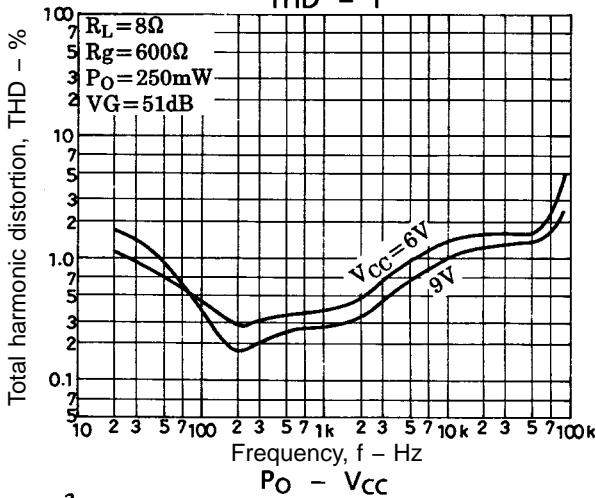
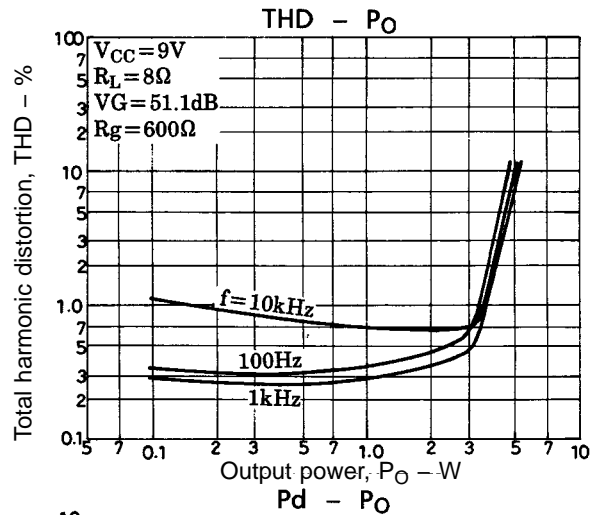
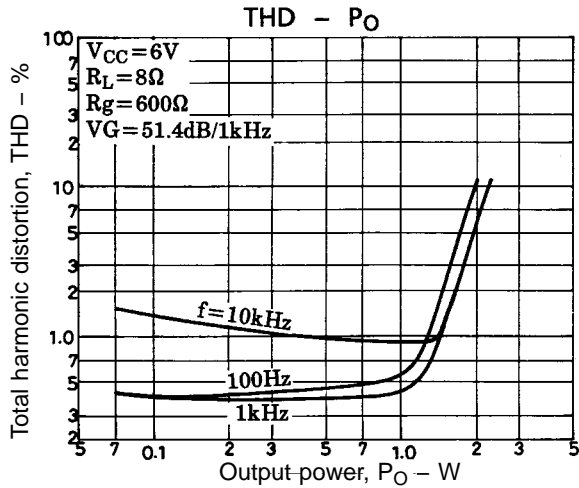

- No products described or contained herein are intended for use in surgical implants, life-support systems, aerospace equipment, nuclear power control systems, vehicles, disaster/crime-prevention equipment and the like, the failure of which may directly or indirectly cause injury, death or property loss.
- Anyone purchasing any products described or contained herein for an above-mentioned use shall:
 - ① Accept full responsibility and indemnify and defend SANYO ELECTRIC CO., LTD., its affiliates, subsidiaries and distributors and all their officers and employees, jointly and severally, against any and all claims and litigation and all damages, cost and expenses associated with such use:
 - ② Not impose any responsibility for any fault or negligence which may be cited in any such claim or litigation on SANYO ELECTRIC CO., LTD., its affiliates, subsidiaries and distributors or any of their officers and employees jointly or severally.
- Information (including circuit diagrams and circuit parameters) herein is for example only; it is not guaranteed for volume production. SANYO believes information herein is accurate and reliable, but no guarantees are made or implied regarding its use or any infringements of intellectual property rights or other rights of third parties.

This catalog provides information as of April, 1996. Specifications and information herein are subject to change without notice.