

No. 1724D

LA4270

6W Dual-Channel AF Power Amp

Features

- . High-output dual-channel AF Power IC
($P_o=6.0W \times 2$, $V_{CC}=25V$, $R_L=8\Omega$, $f=1kHz$, $THD=1.0\%$)
- . Low distortion ($THD=0.1\%$, $V_{CC}=25V$, $R_L=8\Omega$, $f=1kHz$, $P_o=2W$).
- . Minimum number of external parts required (no bootstrap capacitor required).
- . Low pop noise at the time of power switch ON/OFF.
- . High ripple rejection (58dB typ).
- . Wide supply voltage range (10V to 32V).
- . On-chip protector against abnormality (thermal shutdown, overvoltage).

Maximum Ratings at $T_a=25^\circ C$

Parameter	Symbol	Value	Unit
Maximum Supply Voltage	V_{CC} max	35	V
Maximum Output Current	I_O peak	3.5	A
Allowable Power Dissipation	P_d max	20	W
With heat sink. See P_d - T_a graph.			
Operating Temperature	T_{opr}	-20 to +75	$^\circ C$
Storage Temperature	T_{stg}	-40 to +150	$^\circ C$

Operating Conditions at $T_a=25^\circ C$

Parameter	Symbol	Value	Unit
Recommended Supply Voltage	V_{CC}	25	V
Operating Voltage Range	V_{CC} op	10 to 32	V
Recommended Load Resistance	R_L	8	ohm

**Operating Characteristics at $T_a=25^\circ C$, $V_{CC}=25V$, $R_L=8\Omega$, $f=1kHz$, $R_g=600\Omega$,
See specified Test Circuit.**

Parameter	Symbol	THD=1%	min	typ	max	unit
Quiescent Current	I_{CCO}		25	45	90	mA
Voltage Gain	VG		38	40	42	dB
Output Power	P_O		5.0	6.0		W

Continued on next page.

Equivalent Circuit Block Diagram and Pin Assignment

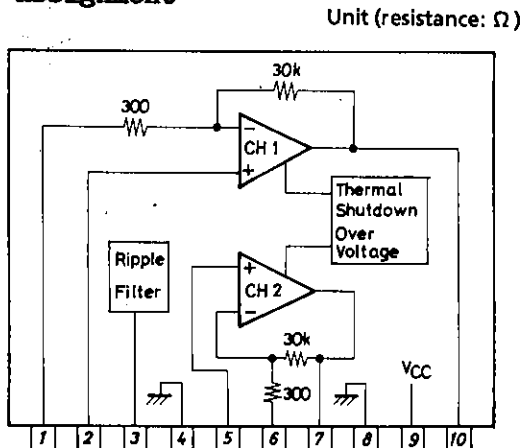

Package Dimensions 3024A
(unit: mm)

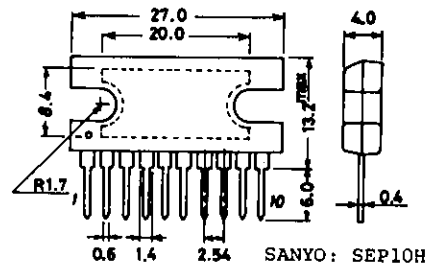

Continued from preceding page.

			min	typ	max	unit
Total Harmonic Distortion THD	$P_O=2W$			0.1	0.8	%
Output Noise Voltage	V_{NO}	$R_g=10k\Omega, BW=20Hz \text{ to } 20kHz$		0.25	1.0	mV
Ripple Rejection	SVRR	$R_g=10k\Omega, f_R=100Hz, V_R=0dBm$	45	58		dB
Crosstalk	CT	$R_g=10k\Omega$	45	60		dB
Channel Balance	ΔVG				1.5	dB

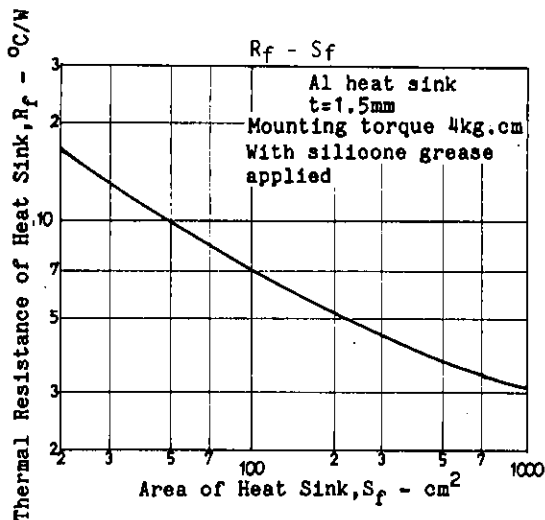
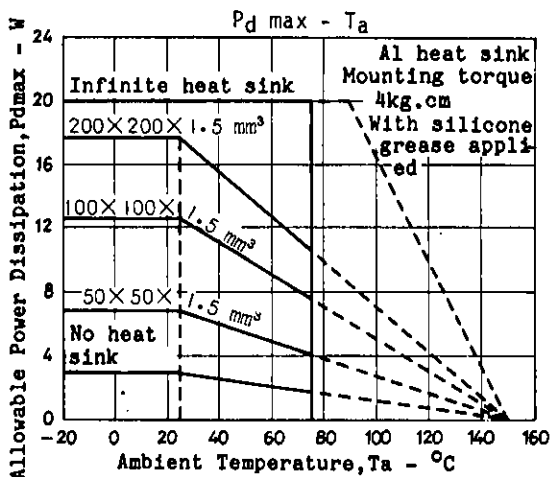

Sample Printed Circuit Pattern

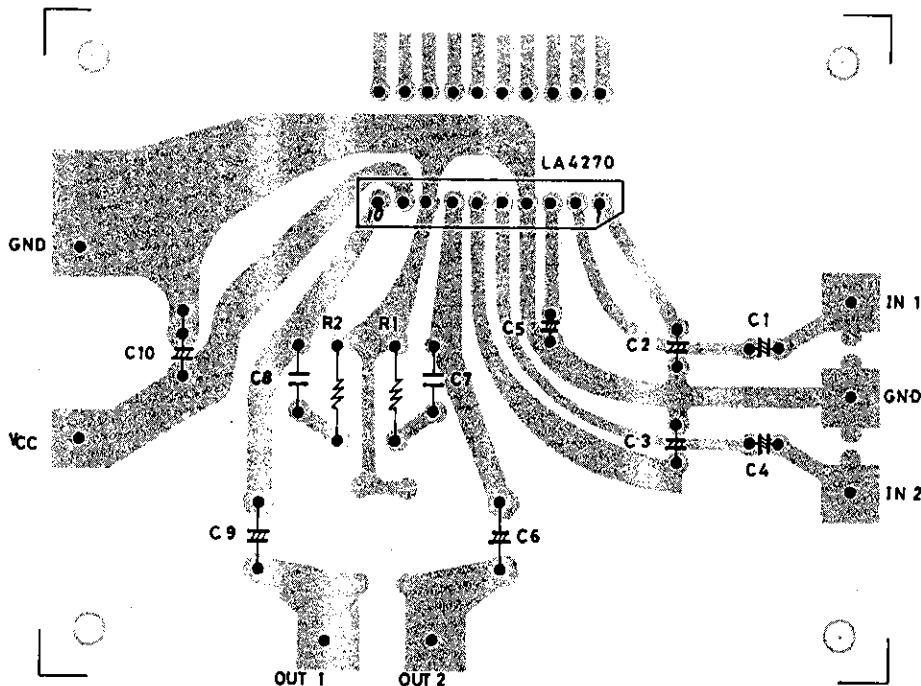

Sample Application Circuit 1 : Dual-channel use (specified Test Circuit)

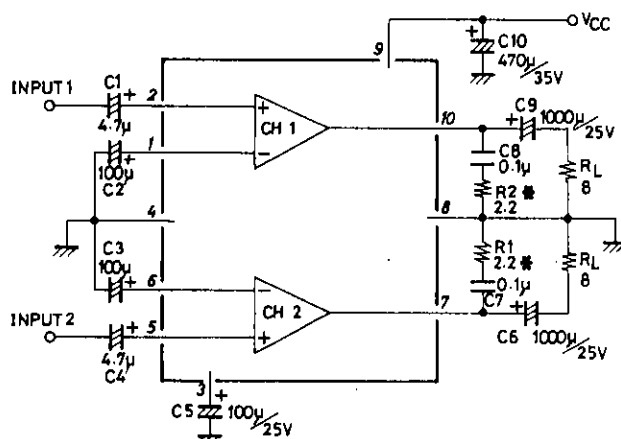

* : Polyester film capacitor

Unit (resistance: Ω , capacitance: F)

Description of External Parts

- C1, C4:** Input capacitors (4.7 μ F)
Since the DC potential of the input pins is not 0, the two capacitors cannot be omitted. Decreasing the capacitor value extremely causes the frequency response to lower at low frequencies.
- C2, C3:** Feedback capacitors (100 μ F)
Decreasing the capacitor value causes the frequency response to lower at low frequencies. Increasing the capacitor value makes the starting time later.
- C5:** Ripple filter capacitor (100 μ F/25V)
Decreasing the capacitor value provides less ripple rejection. Decreasing the capacitor value also makes the starting time earlier.
- C6, C9:** Output capacitors (1000 μ F/25V)
Decreasing the capacitor value provides less power at low frequencies.
- C7, C8:** Oscillation blocking capacitors (0.1 μ F Polyester film capacitors)
Decreasing the capacitor value causes oscillation to be liable to occur. It is recommended to use polyester film capacitors which are excellent in high frequency response, temperature characteristic. The use of electrolytic capacitors or ceramic capacitors may cause oscillation to occur at low temperatures.
- C10:** Power capacitor (470 μ F/35V)
Decreasing the capacitor value causes ripple to be liable to occur. If the distance between the IC and this capacitor is made long or this capacitor is removed, oscillation may occur.
- R1, R2:** Resistors connected in series with oscillation blocking capacitors (2.2ohms)
Used to prevent phase shift attributable to the oscillation blocking capacitors so that oscillation is hard to occur. Increasing or decreasing the resistor value causes oscillation to be liable to occur. The optimum value must be used.

External Muting

1. Lowering of potential at ripple filter pin (pin 3)

Muting can be provided by discharging resistor R connected across pin 3 and GND to lower the potential at pin 3. Too small an R value causes pop noise to occur; and too large an R value causes muting to fail to work.

If no adequate R value is obtained, it is recommended that the R value is made rather small and the C5 value is increased.

2. Application of positive bias to NF pins
- Muting can be provided by positive bias applied to the NF pins. In this case, the R value must be determined so that the potential at the NF pins (pins 1, 6) does not exceed 3V at the muting mode.

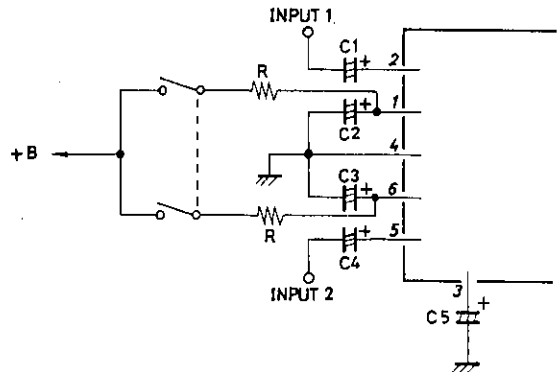
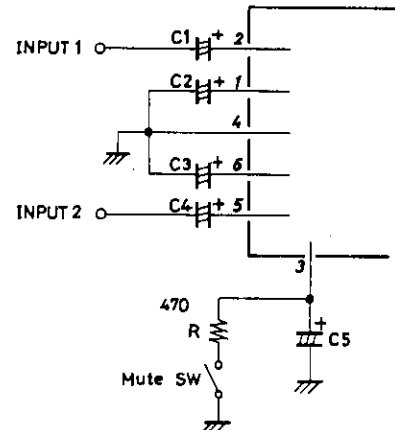

Voltage Gain

The voltage gain is fixed to 40dB by the ratio of on-chip resistors 30kohm and 300ohm. It is impossible to use the IC at a voltage gain greater than this. In an application where the IC is used at a voltage gain of less than 40dB, resistors are connected in series with feedback resistors as shown right. In this application, however, oscillation is liable to occur. So, the voltage gain must not be less than 30dB.

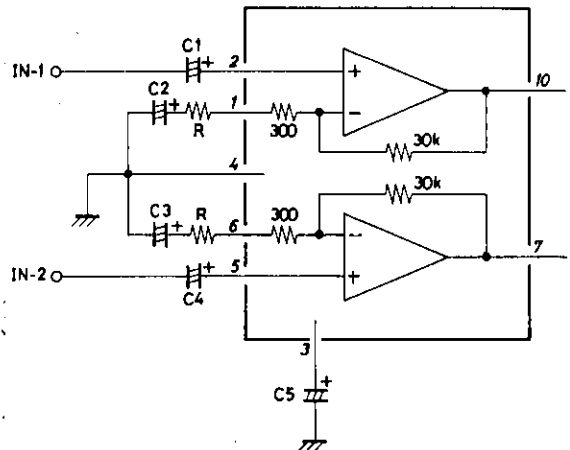

Sample Application Circuit 2 : Bridge amp use

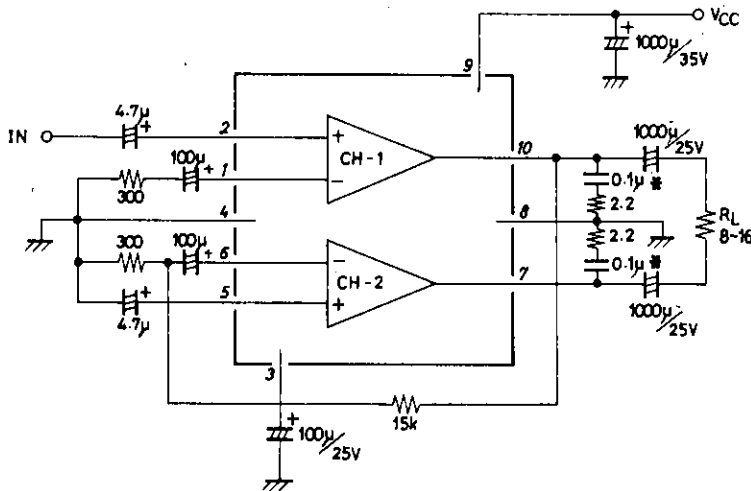

*: Polyester film capacitor

Unit (resistance: Ω, capacitance: F)

In this application, output capacitors must be used. Since the IC handles an apparent load of 4ohm, more distortion results, making it impossible for the IC to deliver power at THD=1% as in 2-channel use. It is possible for the IC to deliver power at THD=5% or 10%.

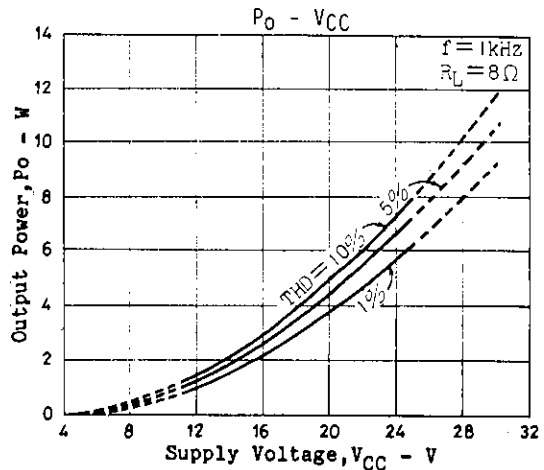
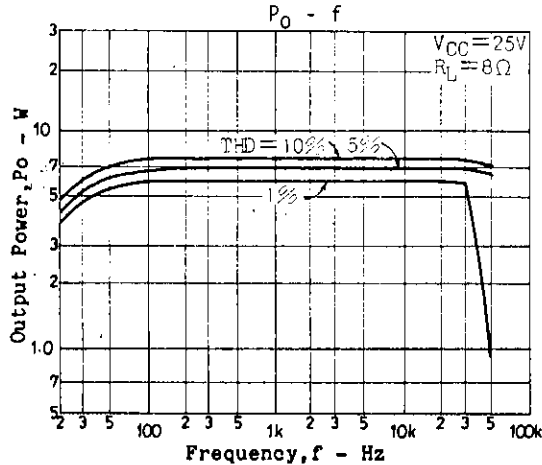
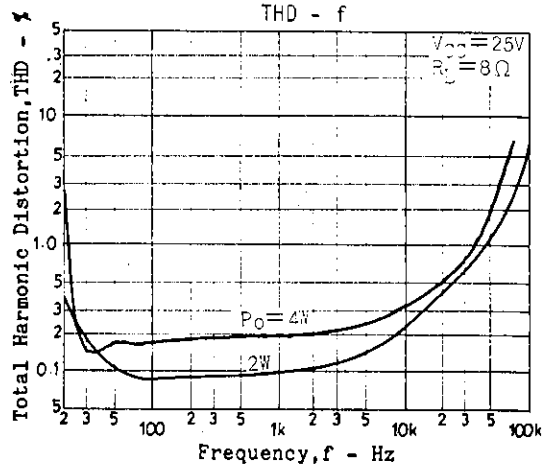
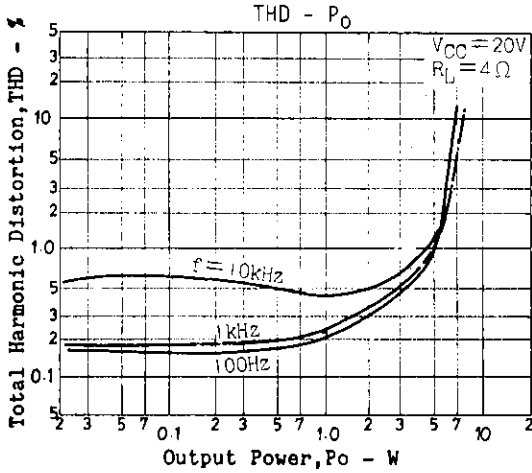
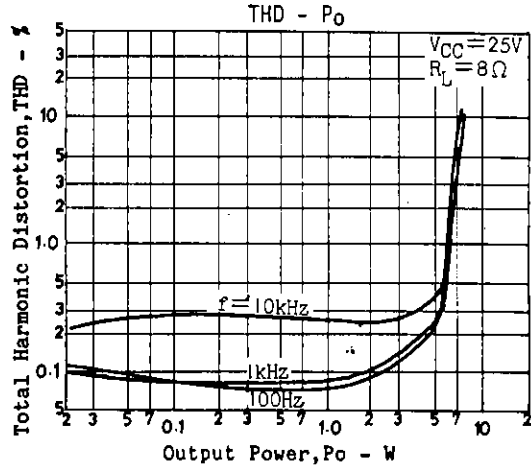
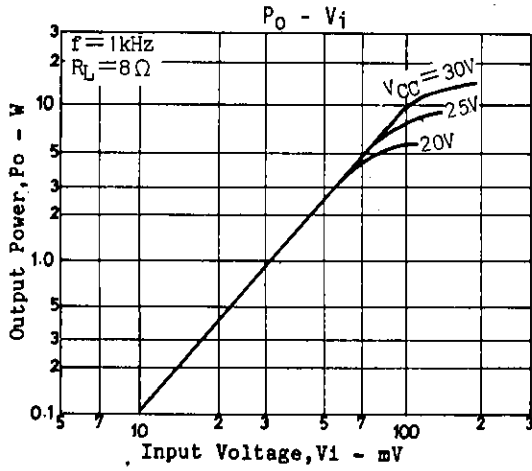

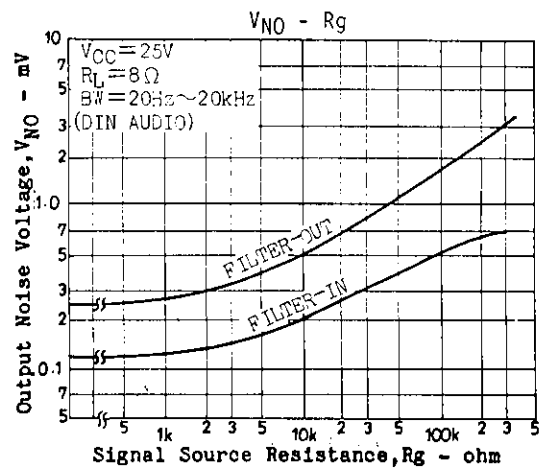
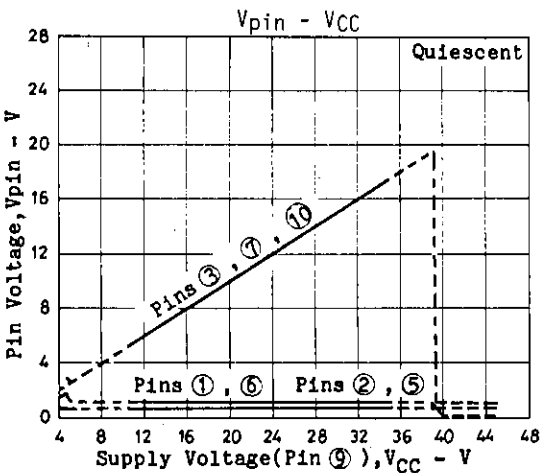
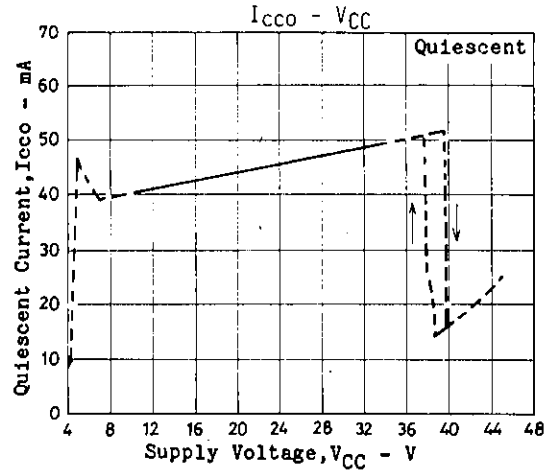
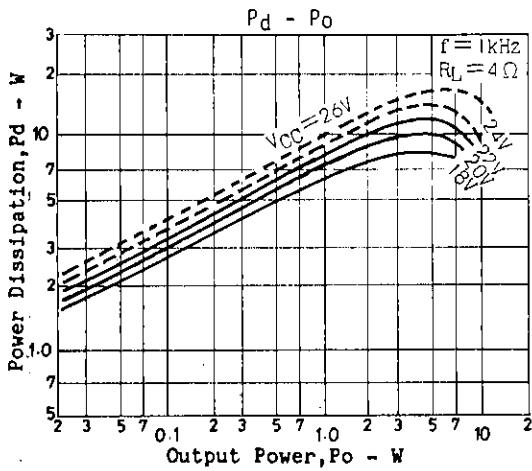
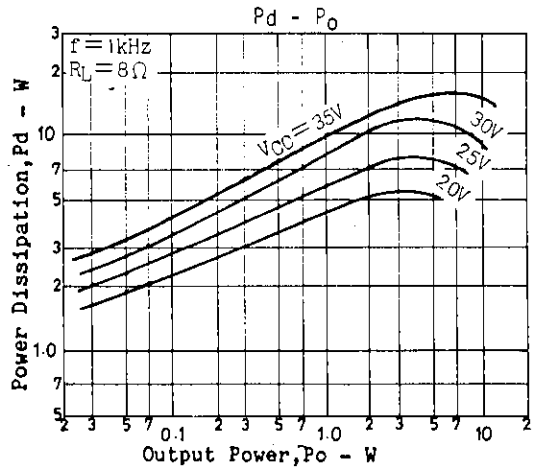
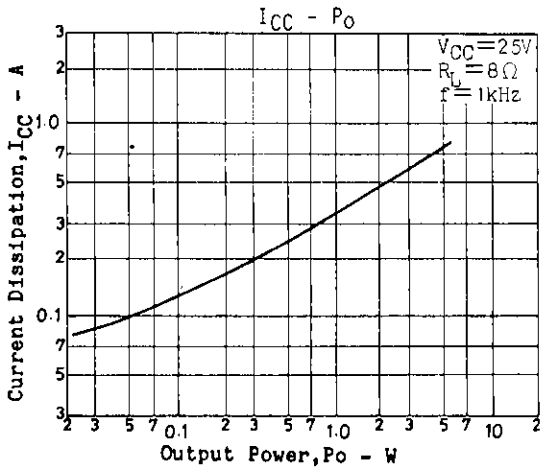
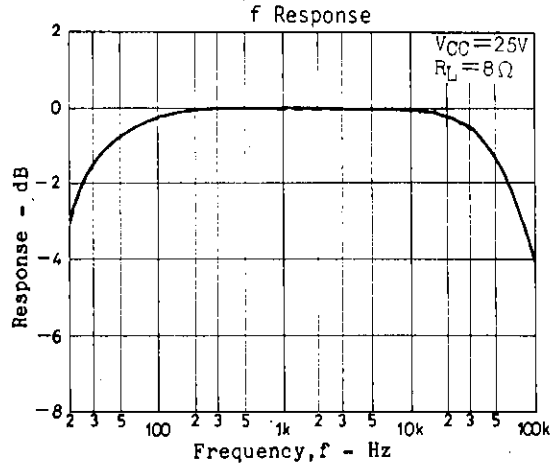
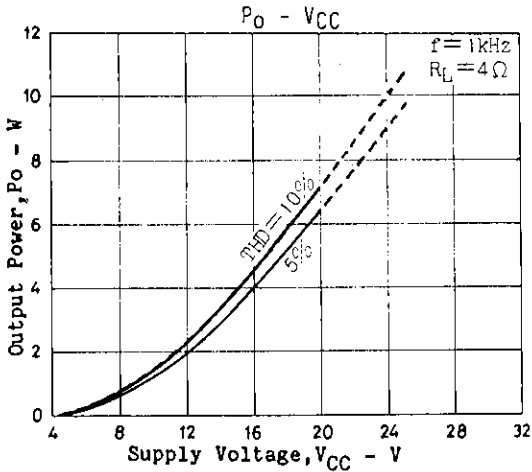

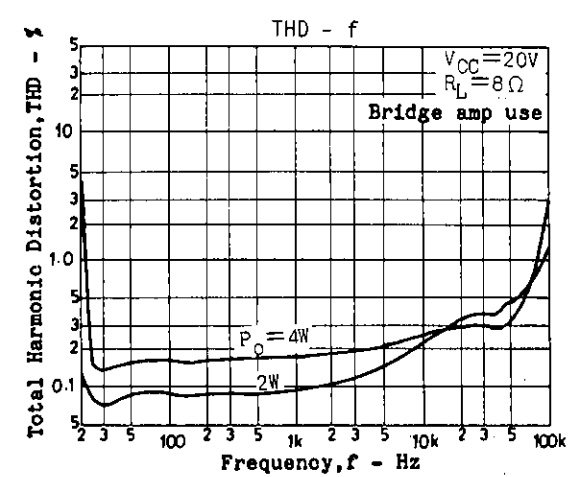
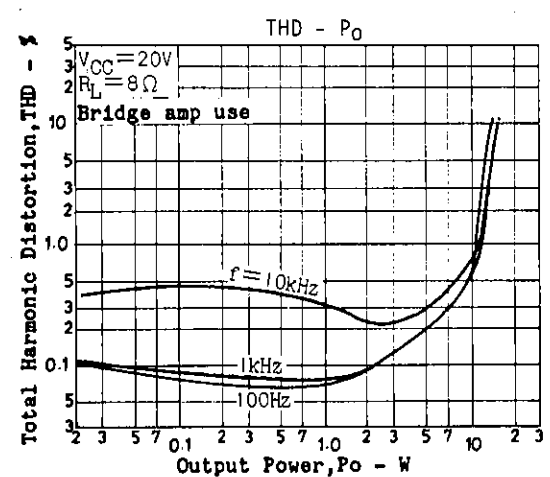
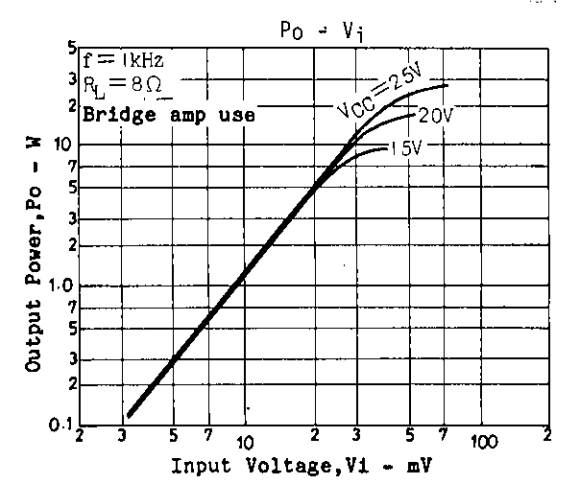
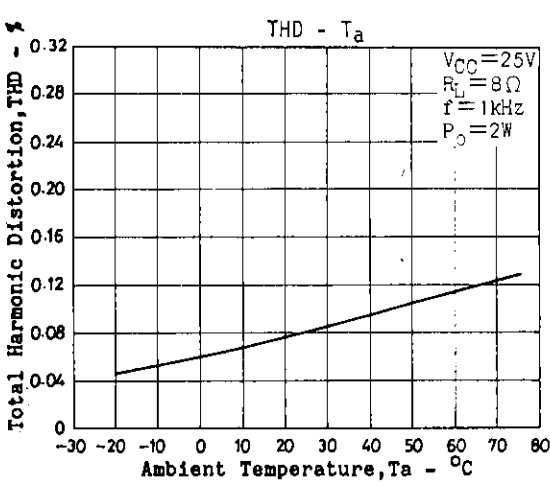
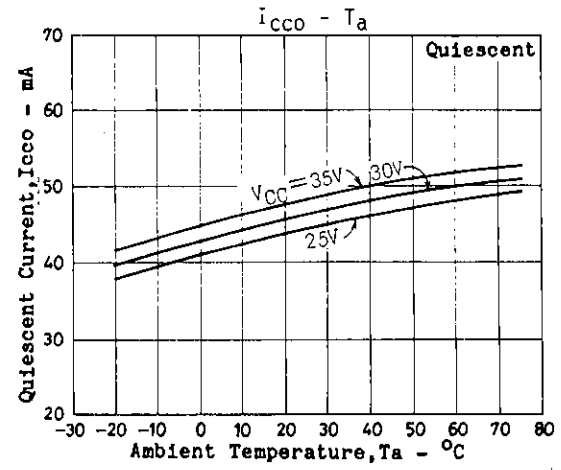
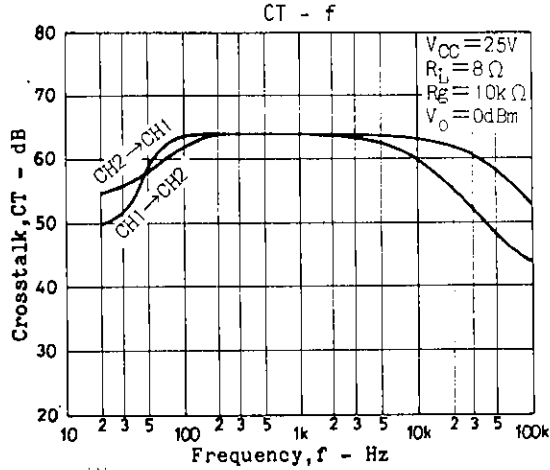
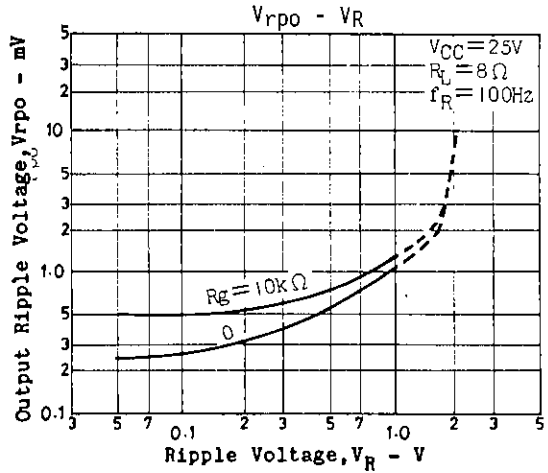
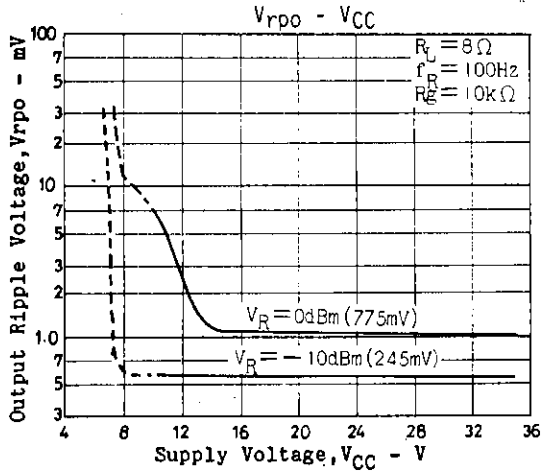

LA4270

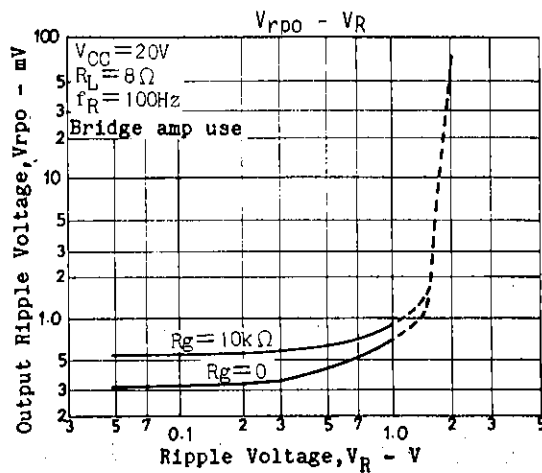
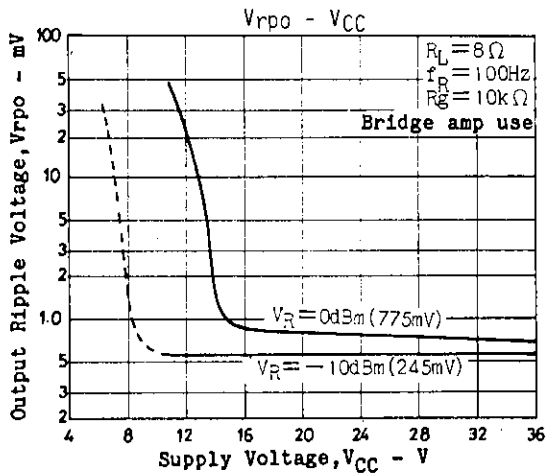
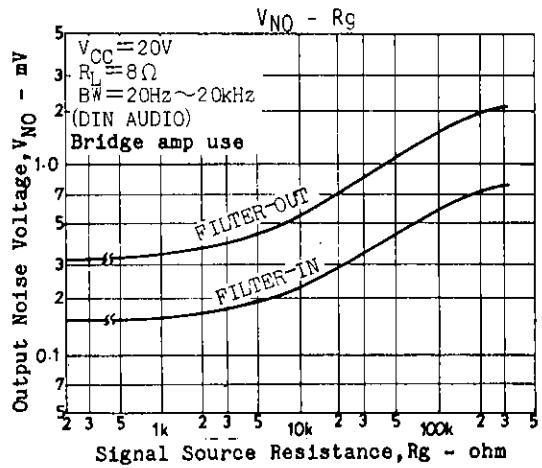
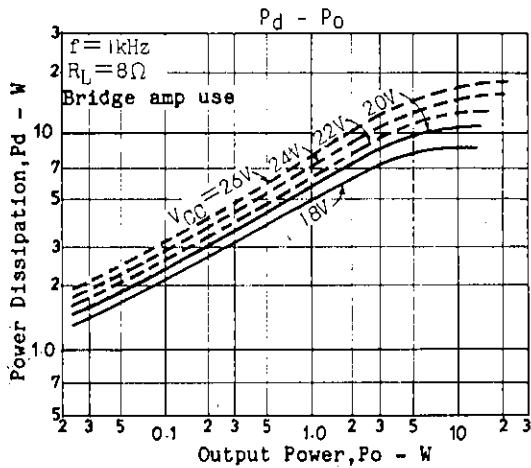
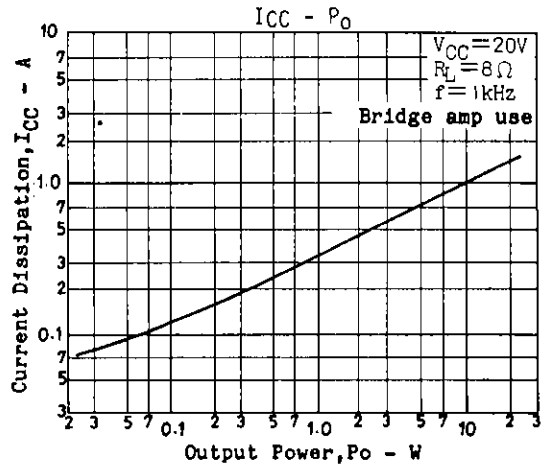
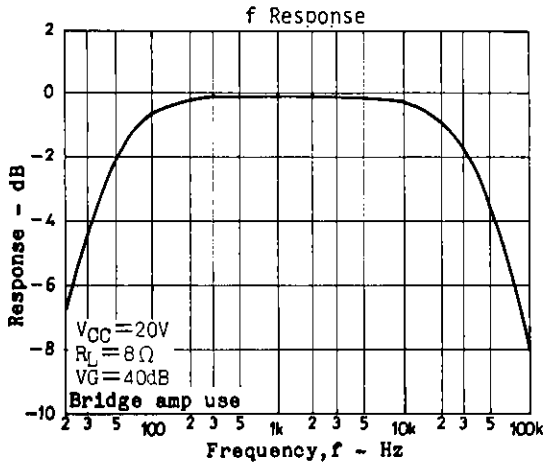
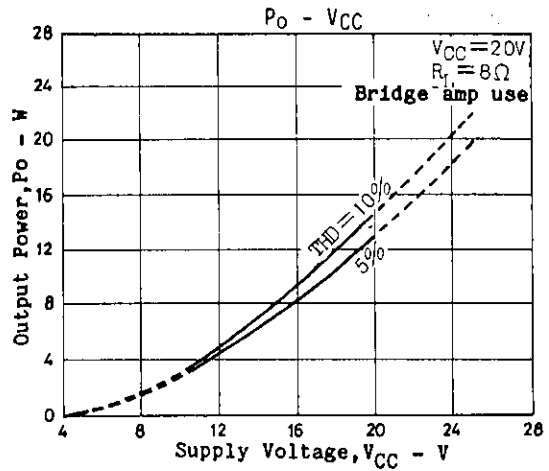
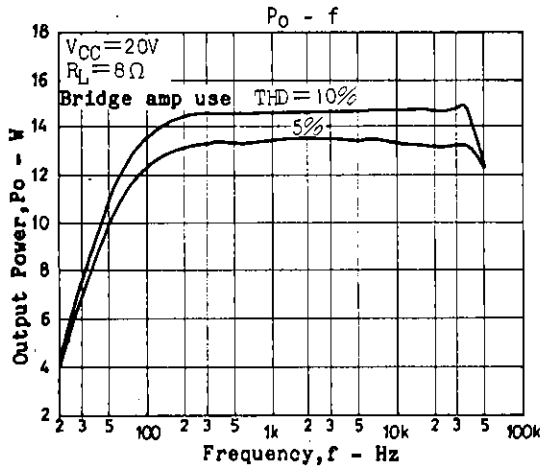

Proper Cares in Using IC

- . Maximum ratings: If the IC is used in the vicinity of the maximum ratings, even a slight variation in conditions may cause the maximum ratings to be exceeded, thereby leading to breakdown. Allow an ample margin of variation for supply voltage, etc. and use the IC in the range where the maximum ratings are not exceeded.
- . Pin-to-pin short: If power is applied when the space between pins is shorted, breakdown or deterioration may occur. When mounting the IC on the board or applying power, make sure that the space between pins is not shorted with solder, etc.
- . When used in radio applications: When using in radios, allow a good distance between IC and bar antenna.
- . Printed circuit pattern: When drawing the printed circuit pattern, make the power supply, output, and ground lines thick and short and arrange the pattern and parts so that no feedback loop is formed between input and output. Place power capacitor C10, oscillation blocking capacitors C7, C8 as close to IC pins as possible to prevent oscillation from occurring. Refer to the sample printed circuit pattern.

Proper cares in Mounting Radiator Fin

1. The mounting torque is in the range of 4 to 6kg.cm.
2. The distance between screw holes of the radiator fin must coincide with the distance between screw holes of the IC. With case outline dimensions L and R referred to, the screws must be tightened with the distance between them as close to each other as possible.

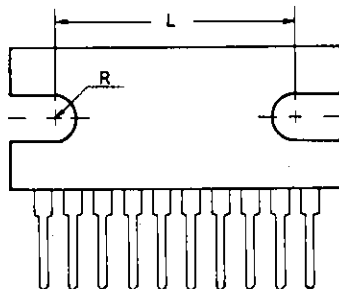

3. The screw to be used must have a head equivalent to the truss machine screw or binder machine screw defined by JIS. Washers must be also used to protect the IC case.
4. No foreign matter such as cutting particles shall exist between heat sink and radiator fin. When applying grease on the junction surface, it must be applied uniformly on the whole surface.
5. IC lead pins are soldered to the printed circuit board after the radiator fin is mounted on the IC.

- No products described or contained herein are intended for use in surgical implants, life-support systems, aerospace equipment, nuclear power control systems, vehicles, disaster/crime-prevention equipment and the like, the failure of which may directly or indirectly cause injury, death or property loss.
- Anyone purchasing any products described or contained herein for an above-mentioned use shall:
 - ① Accept full responsibility and indemnify and defend SANYO ELECTRIC CO., LTD., its affiliates, subsidiaries and distributors and all their officers and employees, jointly and severally, against any and all claims and litigation and all damages, cost and expenses associated with such use.
 - ② Not impose any responsibility for any fault or negligence which may be cited in any such claim or litigation on SANYO ELECTRIC CO., LTD., its affiliates, subsidiaries and distributors or any of their officers and employees jointly or severally.
- Information (including circuit diagrams and circuit parameters) herein is for example only; it is not guaranteed for volume production. SANYO believes information herein is accurate and reliable, but no guarantees are made or implied regarding its use or any infringements of intellectual property rights or other rights of third parties.