**Features**

- Stereo section 9V/3Ω 3W×2, 12V/3Ω 5W×2: noise filter capacitorless power
- Super bus section 9V/3Ω 6W, 12V/3Ω 10W: output capacitor, B-S capacitorless power
This chip employs technology for eliminating pins and external connections to realize 3-dimensional power on a single chip. This IC is a single package power IC for making sound systems with punch.
- On-chip pop noise suppressor
- On-chip power switch circuit
- External and mute functions on chip
- Protection functions on chip (thermal protection circuit and BTL section R_L short protection circuit)

Absolute Maximum Ratings at $T_a = 25^\circ\text{C}$

| | | | unit |
|-----------------------------|----------------|-------------------------|------------------------------|
| Maximum Supply Voltage | V_{CC} max | *1 no signal | 20 V |
| Thermal Resistance | θ_{j-c} | | 2 $^\circ\text{C}/\text{W}$ |
| Maximum Output Current | I_o peak | | 3 A |
| Allowable Power Dissipation | P_d max | With infinite heat sink | 37.5 W |
| Operating Temperature | T_{opr} | | -20 to +75 $^\circ\text{C}$ |
| Storage Temperature | T_{stg} | | -40 to +150 $^\circ\text{C}$ |

Operating Conditions at $T_a = 25^\circ\text{C}$

| | | | unit |
|-----------------------------|-------------|----|-----------------|
| Recommended Supply Voltage | V_{CC} | | 9 V 12 V |
| Recommended Load Resistance | R_L | | 3 to 8 Ω |
| Operating Voltage Range | V_{CC} op | *2 | 5 to 18 V |

*1: Operational notes on the maximum supply voltage

| FRONT L/R | BTL | V_{CC} max | Conditions |
|---------------------|---------------------|--------------|---|
| $R_L \cong 3\Omega$ | $R_L \cong 3\Omega$ | 20V | No signal [Front L/R input with capacitor $R_g=0$ BTL L/R input without capacitor $R_g=0$] |
| $R_L \cong 3\Omega$ | $R_L \cong 4\Omega$ | 21V | |
| $R_L \cong 3\Omega$ | $R_L \cong 5\Omega$ | 22V | |
| $R_L \cong 3\Omega$ | $R_L \cong 6\Omega$ | 23V | |
| $R_L \cong 3\Omega$ | $R_L \cong 7\Omega$ | 24V | |
| $R_L \cong 3\Omega$ | $R_L \cong 8\Omega$ | 24V | |

For power supply transistor regulation, the equivalent power supply line resistance is 3Ω or greater.

*2: The upper limit for V_{CCop} is $V_{CCmax} - 2V$.**Package Dimensions**
(unit: mm)

3109-S18HC

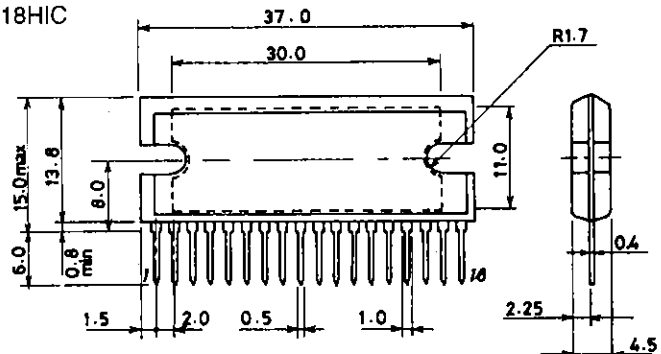

SANYO: SEP18H

LA4630N

[Precaution concerning the metal]

Select P_0 with a goal of a rated load/rated supply voltage of $R_L=3$ to 8Ω and $V_{CC}=5$ to $18V$ and design to avoid exceeding the package P_{dmax} of $37.5 W$. For heavy loads or high V_{CC} , the drive design is involved and the power effect deteriorates, so pay attention to these factors.

Operating Characteristics at $T_a=25^\circ C$, $V_{CC}=9V$, $R_L=3\Omega$, $f=1kHz$

| | | min | typ | max | unit |
|----------------------------------|-----------|-----|------|------|---------|
| Quiescent Flow-in Current | I_{CC0} | 35 | 70 | 140 | mA |
| Standby Current | I_{st} | | 1.0 | 10.0 | μA |
| Power Switch Pin Flow-in Current | I_{sw} | | 10.0 | | mA |
| Mute Supply Flow-in Current | I_{CCm} | | 35.0 | 70.0 | mA |

[Stereo Section]

| | | | min | typ | max | unit |
|--------------------------------|----------|------------------------------|-----|------|------|-----------|
| Output Power | P_{o1} | $V_{CC}=9V, THD=10\%$ | 2.2 | 3.0 | | W |
| | P_{o2} | $V_{CC}=12V, THD=10\%$ | 4.2 | 5.0 | | W |
| Total Harmonic Distortion | THD | $V_0=1V$ | | 0.20 | 1.0 | % |
| Input Resistance | R_i | | | 50 | | $k\Omega$ |
| Voltage Gain | VG | | 43 | 45 | 47 | dB |
| Output Noise Voltage | V_{NO} | $R_g=0, BPF=20Hz$ to $20kHz$ | | 0.15 | 0.40 | mV |
| Ripple Rejection | SVR | $f_R=100Hz, V_R=0dBm$ | 45 | 55 | | dB |
| Channel Separation | ch sep | $R_g=10k\Omega, V_0=0dBm$ | 45 | 50 | | dB |
| Muting Attenuation | A_{tt} | $V_0=0dBm$ | | 80 | | dB |
| Low-Region Roll Off Frequency | f_L | At $VG=-3dB$ | | 50 | | Hz |
| High-Region Roll Off Frequency | f_H | At $VG=-3dB$ | | 50 | | kHz |

[Super Bus Section]

| | | | min | typ | max | unit |
|--------------------------------|-----------|------------------------------|------|------|------|-----------|
| Output Power | P_{o1} | $V_{CC}=9V, THD=10\%$ | 5.0 | 6.0 | | W |
| | P_{o2} | $V_{CC}=12V, THD=10\%$ | 8.0 | 10.0 | | W |
| Total Harmonic Distortion | THD | $V_0=1V$ | | 0.20 | 1.0 | % |
| Input Resistance | R_i | | | 30 | | $k\Omega$ |
| Voltage Gain | VG | | 43 | 45 | 47 | dB |
| Output Noise Voltage | V_{NO} | $R_g=0, BPF=20Hz$ to $20kHz$ | | 0.3 | 0.6 | mV |
| Ripple Rejection | SVR | $f_R=100Hz, V_R=0dBm$ | 50 | 60 | | dB |
| Muting Attenuation | A_{tt} | $V_0=0dBm$ | | 80 | | dB |
| Low-Region Roll Off Frequency | f_L | $VG:-3dB$ | | 5 | | Hz |
| High-Region Roll Off Frequency | f_H | $VG:-3dB$ | | 40 | | kHz |
| Output Offset Voltage | V_{OFF} | $R_g=0$ | -150 | | +150 | mV |

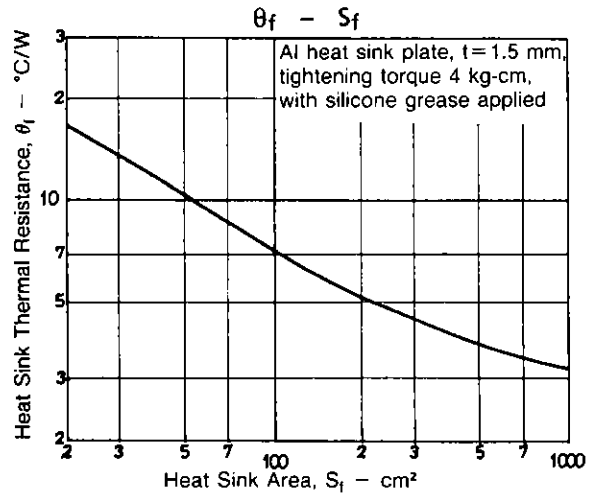
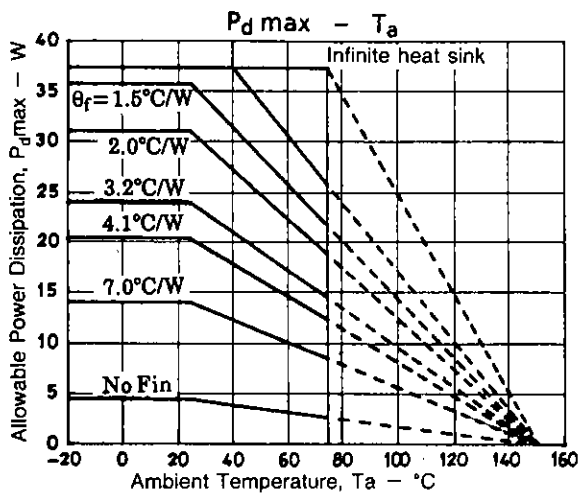

LA4630N

Block Diagram

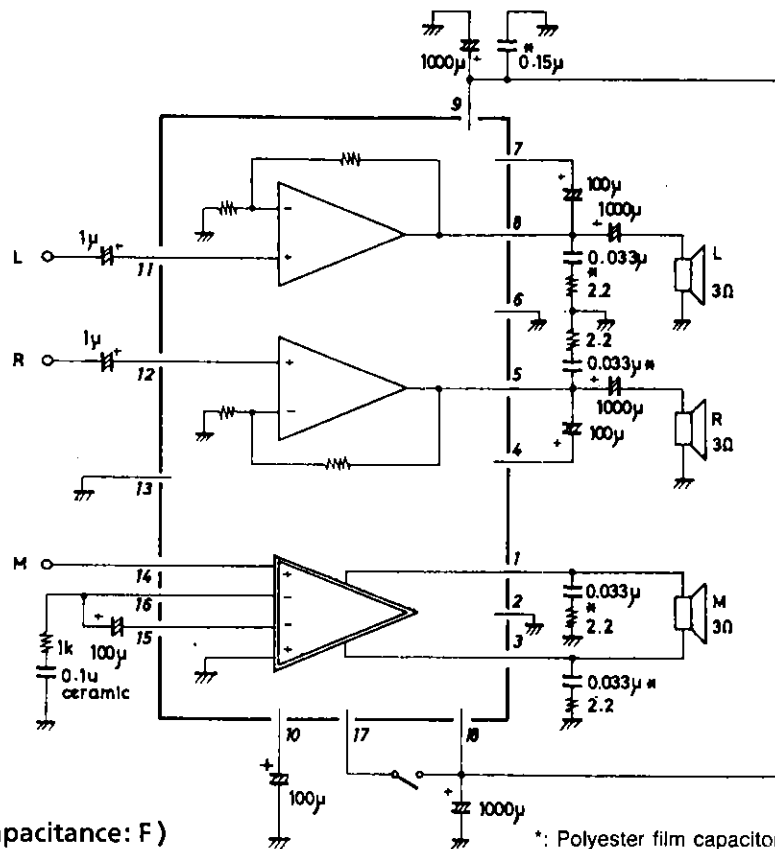

Note 1: The motor should not be connected to the power switch pin, since transient noise may appear on the amplifier outputs when the motor is started or stopped.

Note 2: Audio mute is enabled by connecting a 300 Ω resistance between the DC pin and ground. DC bias control of both the stereo (L ch, R ch) and BTL (super bass) channels is enabled, and all audio output signals can be muted by controlling the MUTE pin.

Sample Printed Circuit Pattern

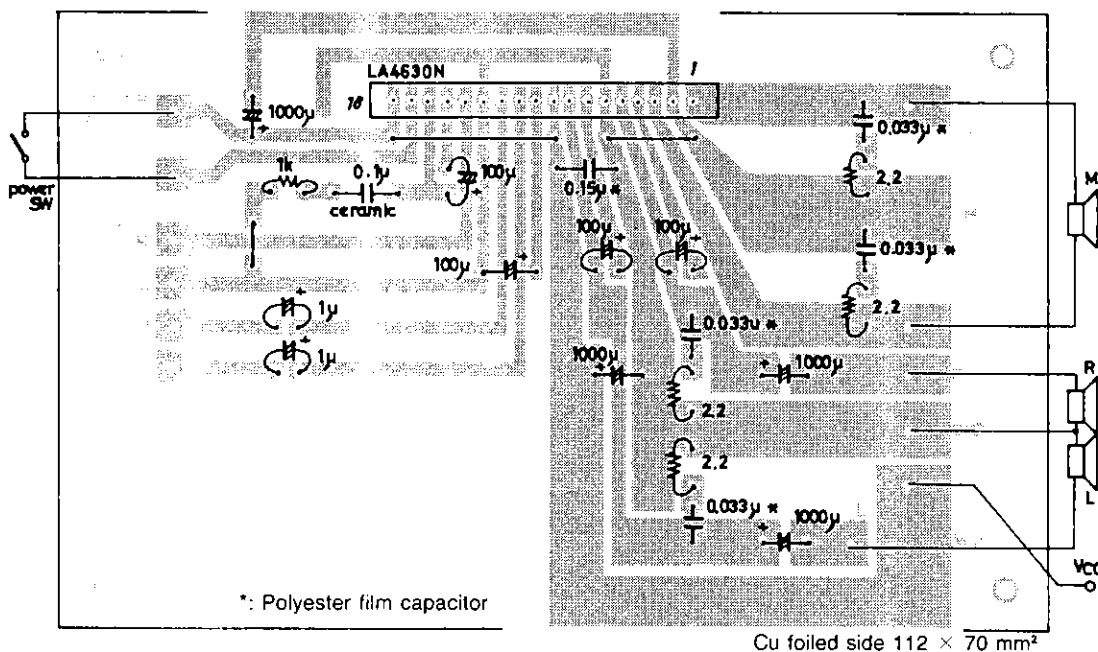

※: Insert 0.15 µF between power supply and ground at the root of the pins.

Unit (resistance: Ω, capacitance: F)

LA4630N

Pin Voltages

| | | | | | | | | | |
|-----------------|--------|-----------|---------|------|-------|-----------|------|-------|-------------------|
| Pin No. | 1 | 2 | 3 | 4 | 5 | 6 | 7 | 8 | 9 |
| Name | OUT No | PWR GND 2 | OUT Inv | BS R | OUT R | PWR GND 1 | BS L | OUT L | V _{CC} 1 |
| Pin voltage (V) | 4.0 | 0 | 4.0 | 8.1 | 4.5 | 0 | 8.1 | 4.0 | 9.0 |

| | | | | | | | | | |
|-----------------|-----|------|------|---------|---------|--------|-------|--------|-------------------|
| Pin No. | 10 | 11 | 12 | 13 | 14 | 15 | 16 | 17 | 18 |
| Name | DC | IN L | IN R | PRE GND | IN No | NF Inv | NF No | PWR SW | V _{CC} 2 |
| Pin voltage (V) | 4.5 | 1.4 | 1.4 | 0 | 21 [mV] | 1.4 | 1.4 | 9.0 | 9.0 |

P_o Chart

(THD=10%)

| Item | R _L | 9V | 12V | 15V |
|-----------|----------------|-------|-------|-------|
| FRONT L/R | 8Ω | 1.4W | 2.5W | 3.9W |
| | 6Ω | 1.75W | 3.2W | 5.0W |
| | 4Ω | 2.4W | 4.3W | 6.4W |
| | 3Ω | 3.2W | 5.6W | — |
| BTL | 8Ω | 3.2W | 6.4W | 11.0W |
| | 6Ω | 4.0W | 8.1W | 13.5W |
| | 4Ω | 5.3W | 10.4W | — |
| | 3Ω | 6.4W | 12.4W | — |

Pdmax Chart

| Item | R _L | 9V | 12V | 15V |
|-----------|----------------|------|-------|------|
| FRONT L/R | 8Ω | 2.0W | 3.2W | 4.6W |
| | 6Ω | 2.4W | 3.8W | 5.7W |
| | 4Ω | 3.1W | 5.0W | 5.4W |
| | 3Ω | 3.8W | 6.2W | — |
| BTL | 8Ω | 2.8W | 4.8W | 7.2W |
| | 6Ω | 3.6W | 6.0W | 9.0W |
| | 4Ω | 5.0W | 8.8W | — |
| | 3Ω | 6.3W | 11.2W | — |

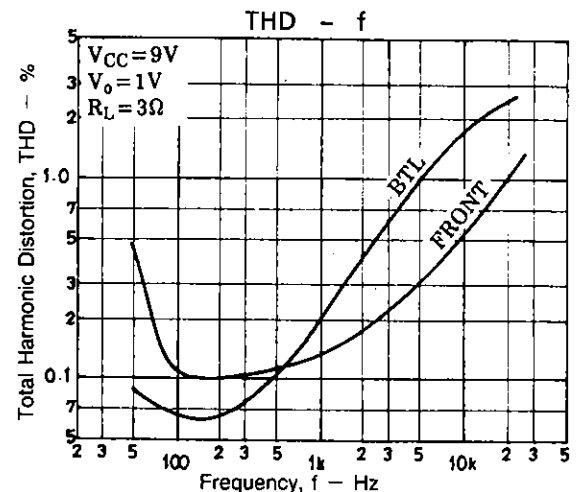
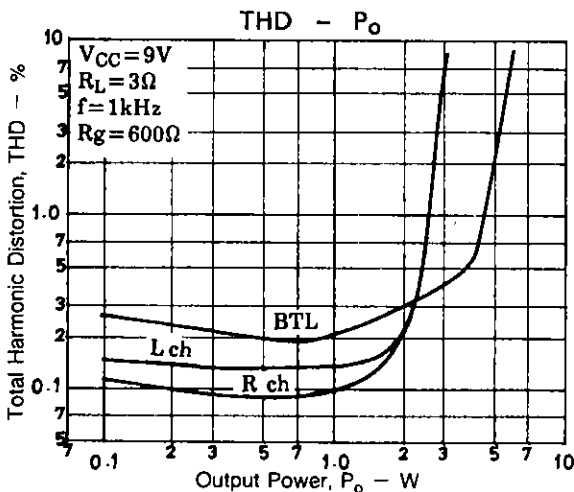
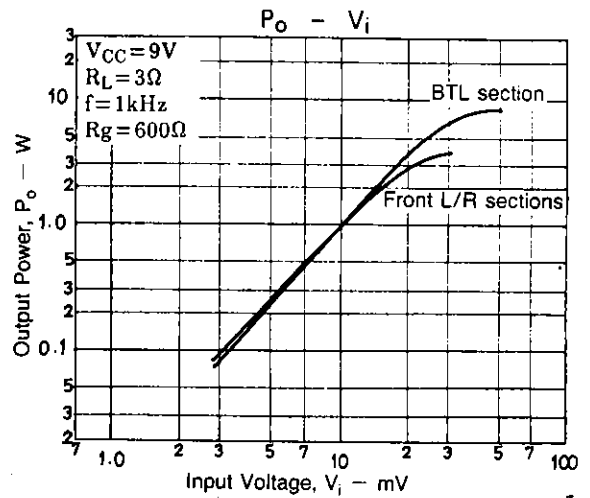
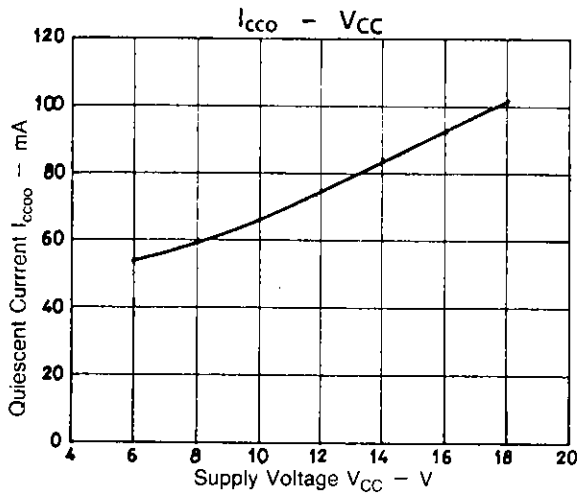

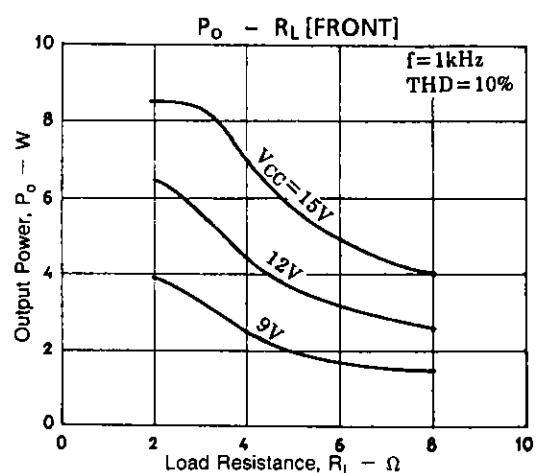
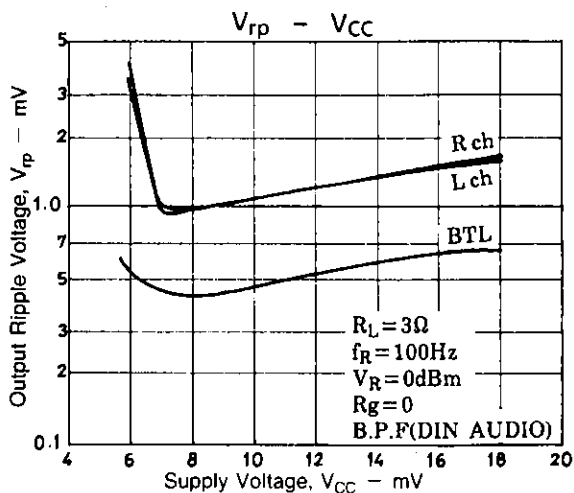
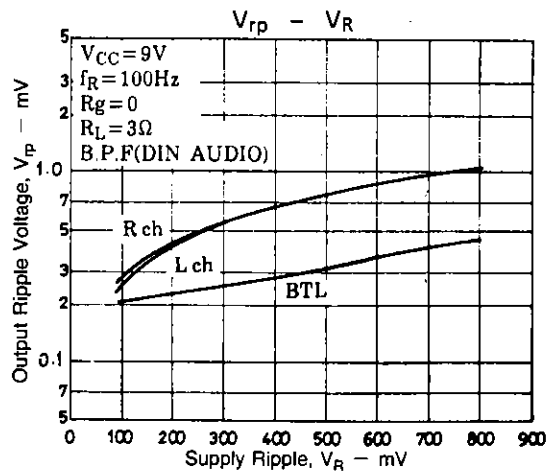
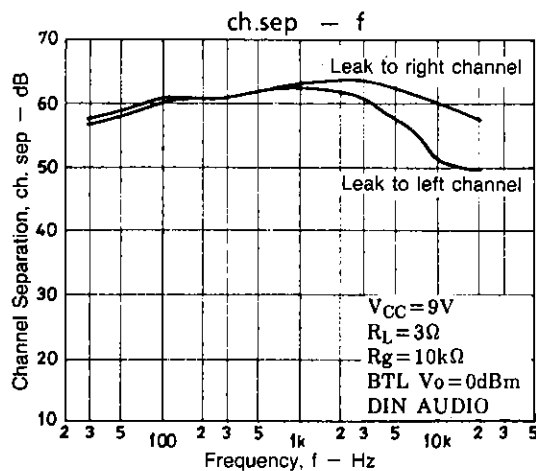
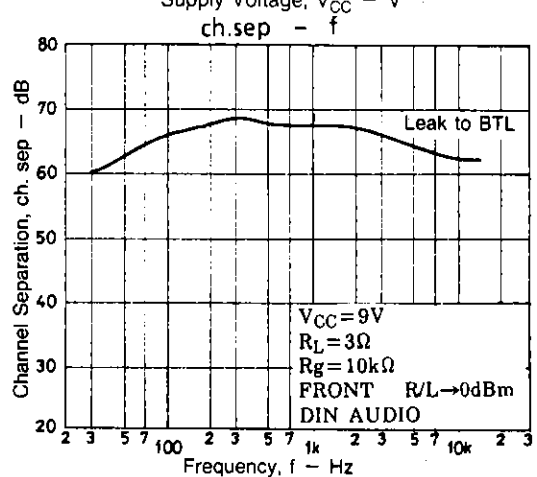
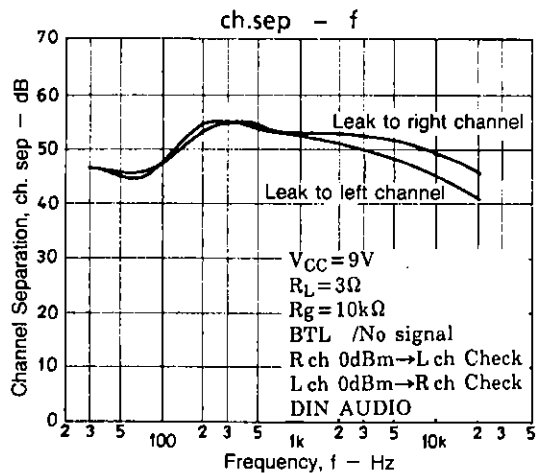
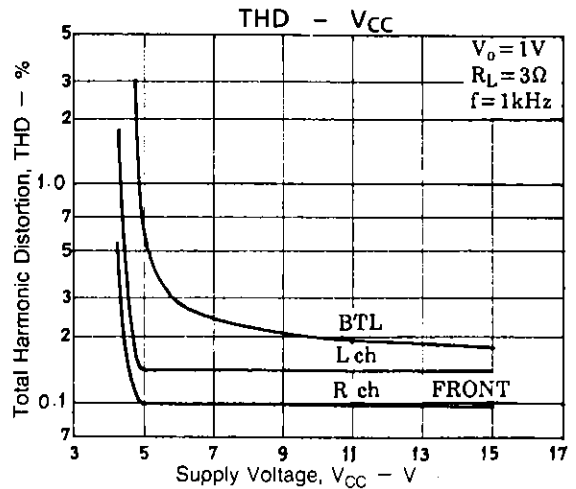
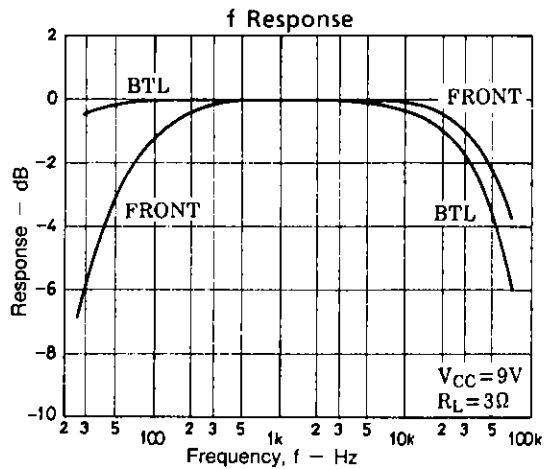

LA4630N

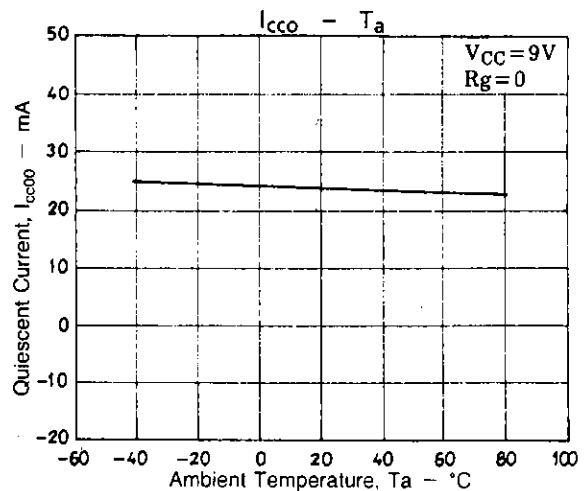
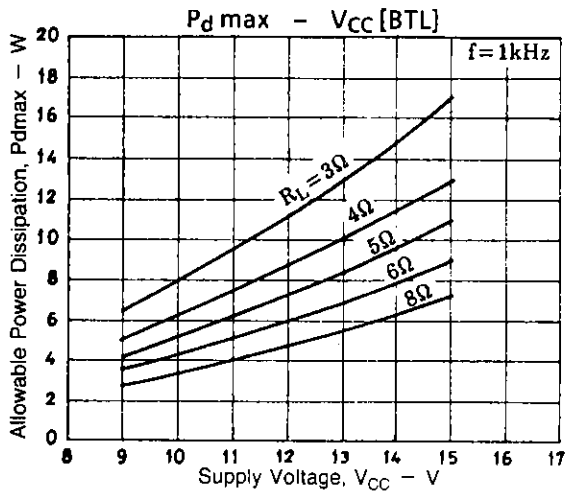
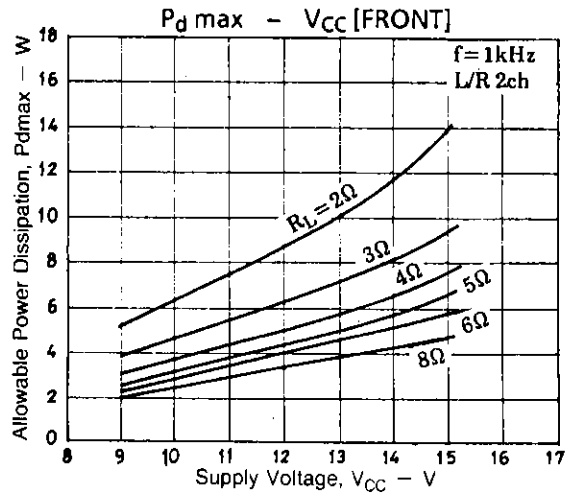
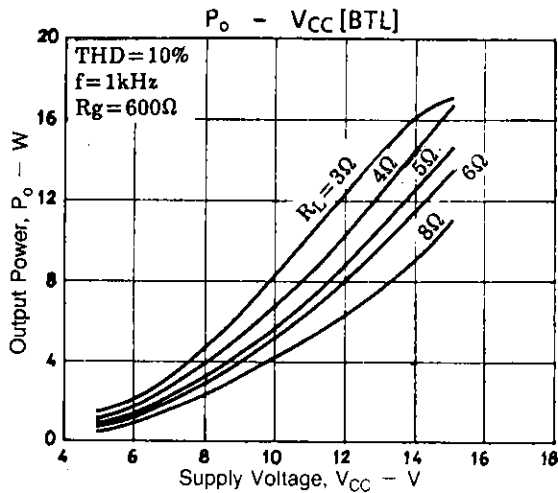
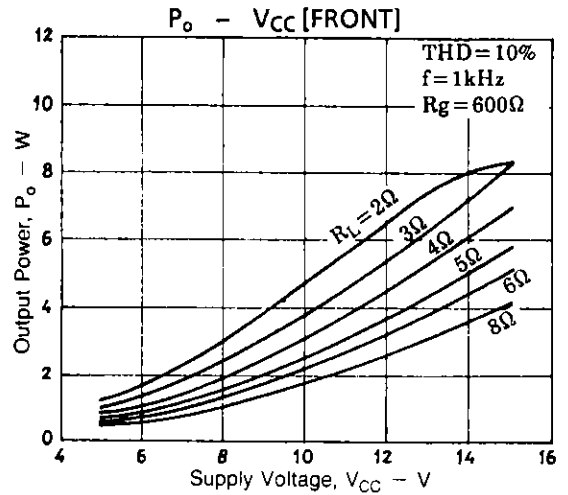
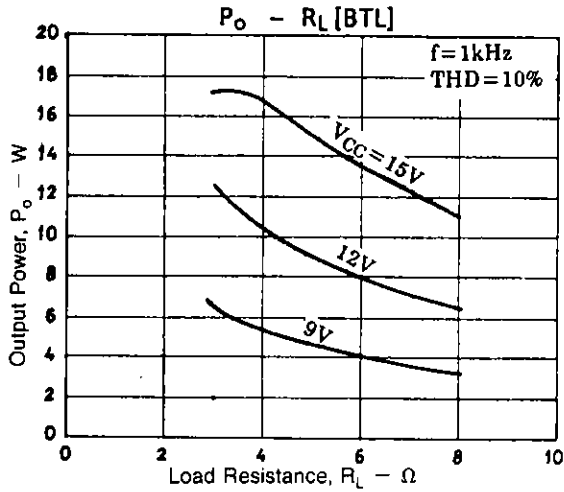

Notes on using this IC

- Always short power supply pins 9 and 16 on the copper foil of the printed circuit pattern and apply the equivalent power supply voltage.
- Pin 17 is designed for the power switch.
It can be switched on and off with a small current capacitance switch, but the point to watch out for is that if the voltage loss between pins 17 and 18 is too large, there may be problems in the biasing and the power may drop.
- When switching with a transistor, the general practice is to insert a PNP transistor between pins 17 and 18.

LA4630N

Notes on Mounting Radiator Fin

1. The tightening torque should be in the range of 4 to 6 kg-cm.
2. The distance between screw holes of the radiator fin must coincide with the distance between screw holes of the IC. With case outline dimensions L and R referred to the screws must be tightened with the distance between them as close to each other as possible.

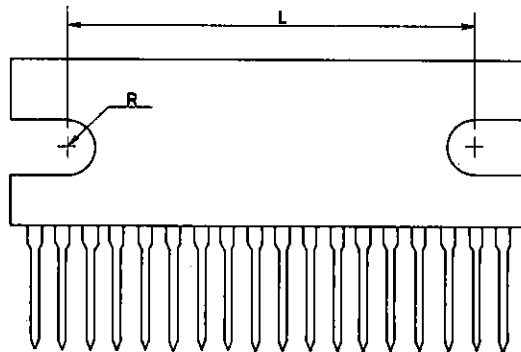

3. The screws to be used must have a head equivalent to the one of truss machine screw or binder machine screw defined by JIS. Washers must be also used to protect the IC case.
4. No foreign matter such as cutting particles shall exist between heat sink and radiator fin. When applying grease on the junction surface, it must be applied uniformly on the whole surface.
5. IC lead pins are soldered to the printed circuit board after the radiator fin is mounted on the IC.

- No products described or contained herein are intended for use in surgical implants, life-support systems, aerospace equipment, nuclear power control systems, vehicles, disaster/crime-prevention equipment and the like, the failure of which may directly or indirectly cause injury, death or property loss.
- Anyone purchasing any products described or contained herein for an above-mentioned use shall:
 - ① Accept full responsibility and indemnify and defend SANYO ELECTRIC CO., LTD., its affiliates, subsidiaries and distributors and all their officers and employees, jointly and severally, against any and all claims and litigation and all damages, cost and expenses associated with such use:
 - ② Not impose any responsibility for any fault or negligence which may be cited in any such claim or litigation on SANYO ELECTRIC CO., LTD., its affiliates, subsidiaries and distributors or any of their officers and employees jointly or severally.
- Information (including circuit diagrams and circuit parameters) herein is for example only; it is not guaranteed for volume production. SANYO believes information herein is accurate and reliable, but no guarantees are made or implied regarding its use or any infringements of intellectual property rights or other rights of third parties.