

SANYO

No.1187E

LA5000 Series2 to 5V 60mA
Low Saturation Voltage Regulators

The LA5002, 5003, 5004, 5005 are voltage regulators having a small input-output voltage drop (0.2V typ.) They are especially suited for use in battery-powered low voltage equipment and commercial or industrial equipment having a large voltage regulation.

Features

- Small input-output voltage drop (0.2V/ $I_{OUT}=20\text{mA}$ typ.)
- Minimum number of external parts required
- Highly resistant against load short
- Radio noise (radiation) control pin

Maximum Ratings at $T_a=25^\circ\text{C}$

			unit
Input Supply Voltage	V_{IN} max	12	V
Output Current	I_{OUT} max	60	mA
Allowable Power Dissipation	P_d max	560	mW
Operating Temperature	T_{opr}	-20 to +80	$^\circ\text{C}$
Storage Temperature	T_{stg}	-30 to +125	$^\circ\text{C}$

Electrical Characteristics at $T_a=25^\circ\text{C}$, $C_{OUT}=10\mu\text{F}$, $I_{OUT}=20\text{mA}$, $V_{IN}=3\text{V}$ [LA5002], $V_{IN}=4\text{V}$ [5003], $V_{IN}=5\text{V}$ [LA5004], $V_{IN}=6\text{V}$ [LA5005]

			min	typ	max	unit
Output Voltage	V_O	LA5002	1.85	2.0	2.15	V
		LA5003	2.8	3.0	3.2	V
		LA5004	3.75	4.0	4.25	V
		LA5005	4.75	5.0	5.25	V
Line Regulation	V_O line	LA5002: $2.5\text{V} < V_{IN} < 8\text{V}$			50	mV
		LA5003: $3.5\text{V} < V_{IN} < 9\text{V}$			50	mV
		LA5004: $4.5\text{V} < V_{IN} < 10\text{V}$			50	mV
		LA5005: $5.5\text{V} < V_{IN} < 11\text{V}$			50	mV
Load Regulation	V_O load	$1\text{mA} < I_{OUT} < 40\text{mA}$			20	mV
		$1\text{mA} < I_{OUT} < 50\text{mA}$			25	mV
Quiescent Current	I_{CCO}	LA5002	1.2	2.0		mA
		LA5003	1.4	2.0		mA
		LA5004	1.5	2.3		mA
		LA5005	1.7	2.5		mA

Continued on next page.

Package Dimensions 3027A-S4HTR
(unit: mm)

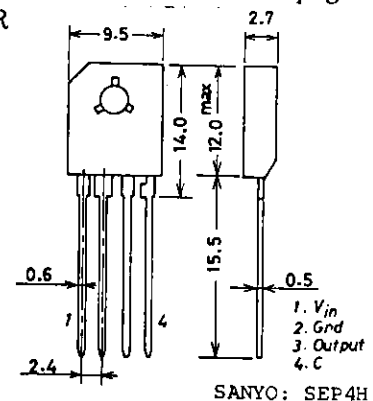

SANYO Electric Co., Ltd. Semiconductor Business Headquarters
TOKYO OFFICE, Tokyo Bldg., 1-10, 1 Chome, Ueno, Taito-ku, TOKYO, 110 JAPAN

LA5000 Series

Continued from preceding page.

			min	typ	max	unit
Ripple Voltage	R_T	LA5002, LA5004, LA5005: $f = 120\text{Hz}$	40			dB
		LA5003: $f = 120\text{Hz}$	43			dB
Input/Output Voltage Drop	V_{drop}			0.2	0.3	V
Coefficient of Output Voltage	$K\Delta V_o/\Delta T$		-1		+1	mV/°C
	V_N	$10\text{Hz} < f < 100\text{kHz}$		30		μV

Equivalent Circuit Block Diagram

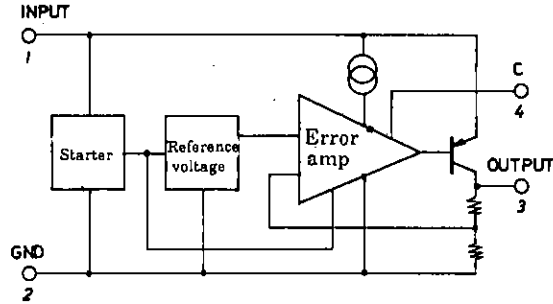

Sample Application Circuit

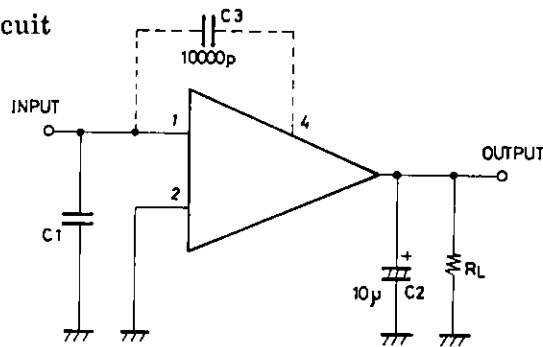

Unit (capacitance: F)

Note: Capacitor C3 is not required unless radio noise is a problem.

Test Circuits

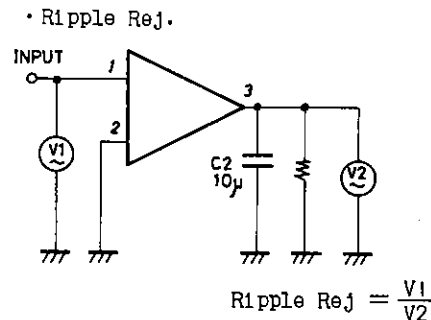
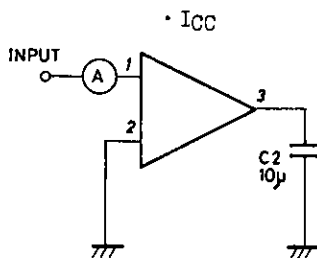
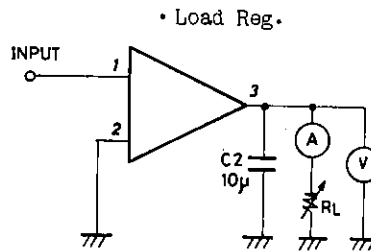
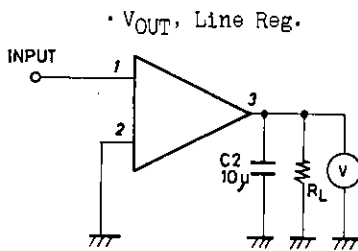

Unit (capacitance: F)

LA5000 Series

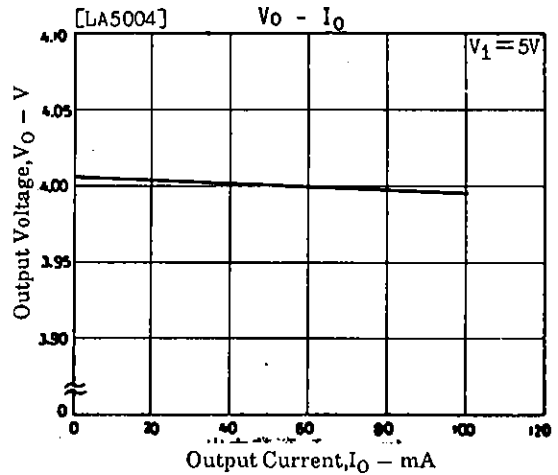
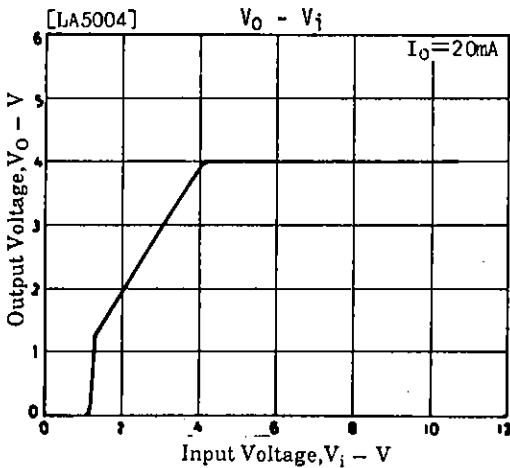
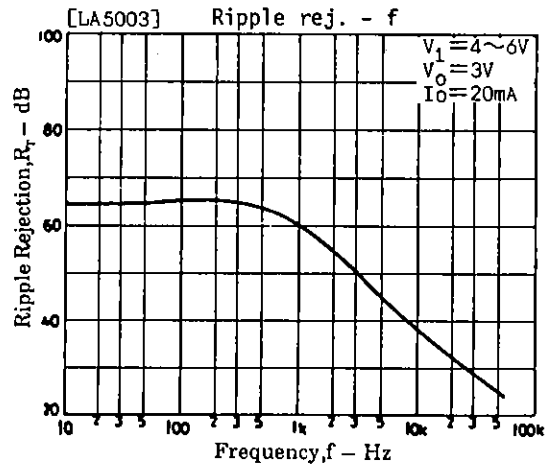
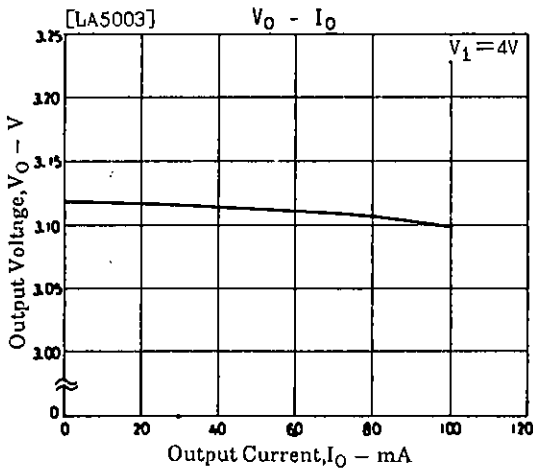
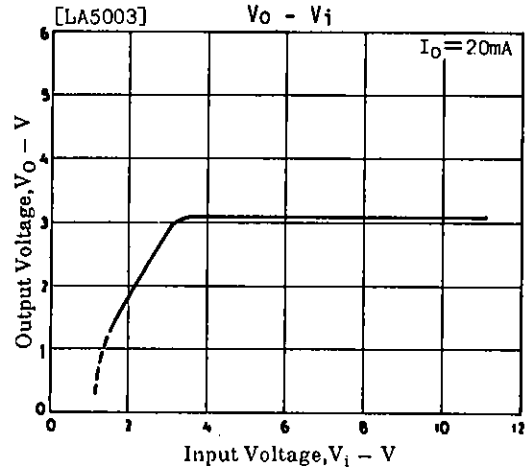
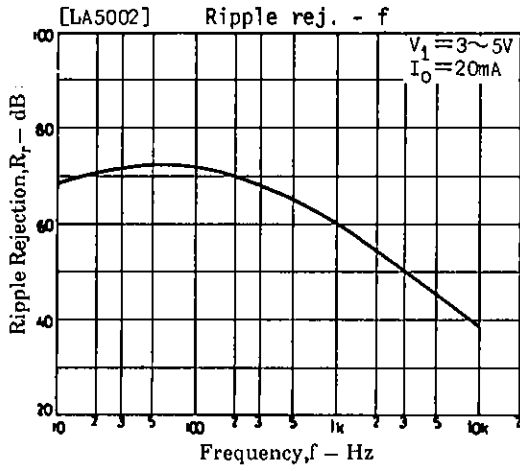
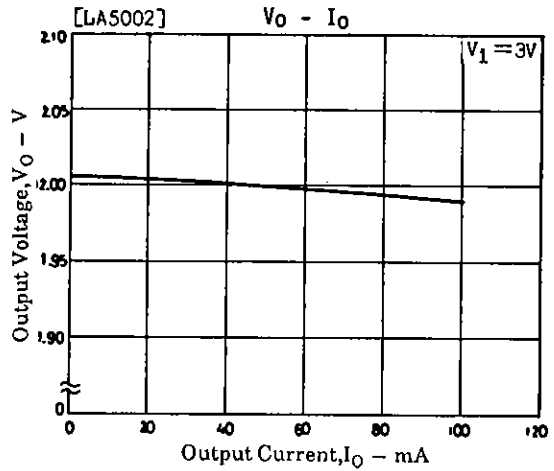
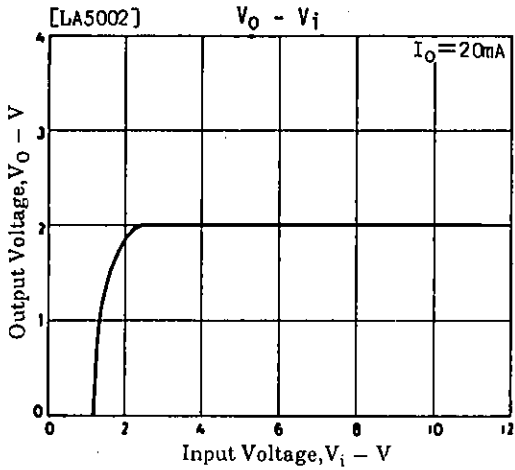

LA5000 Series

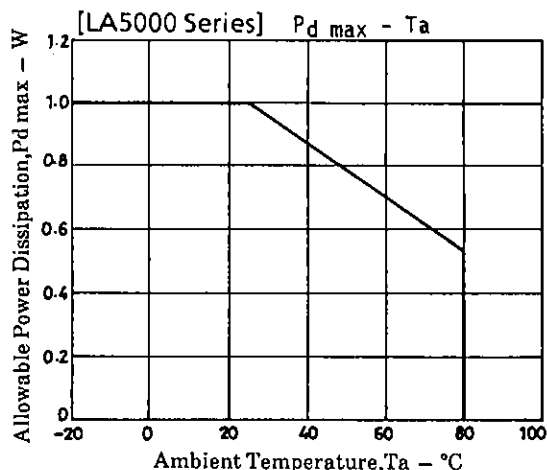
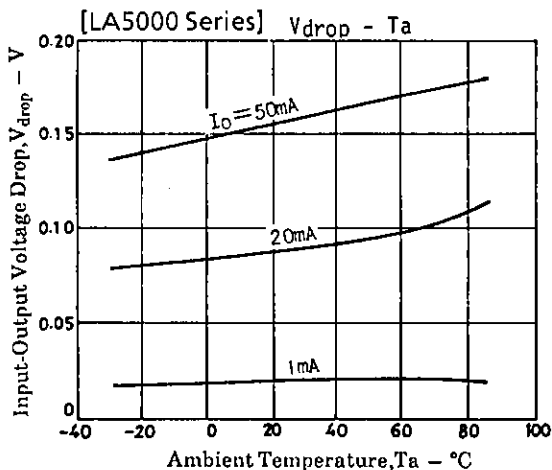
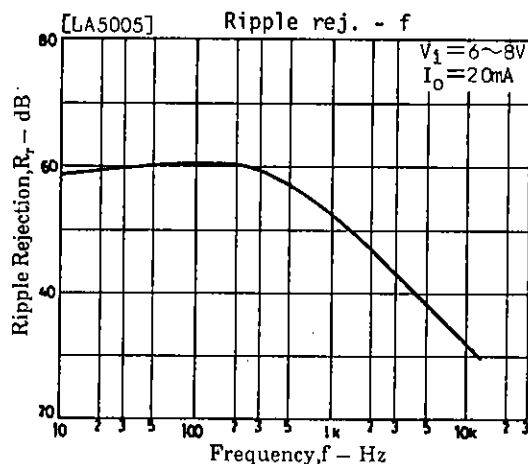
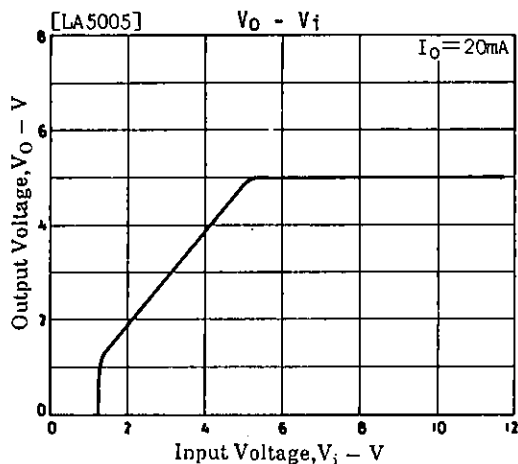
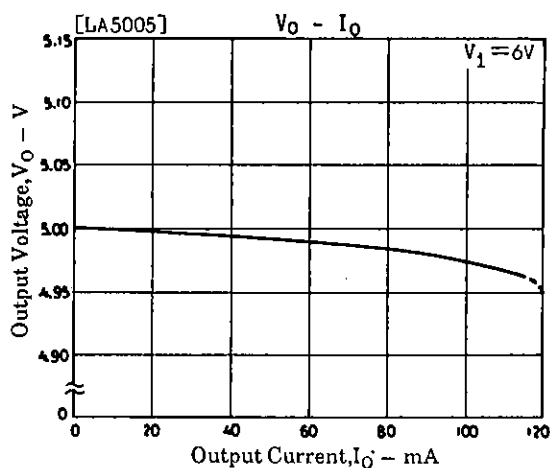
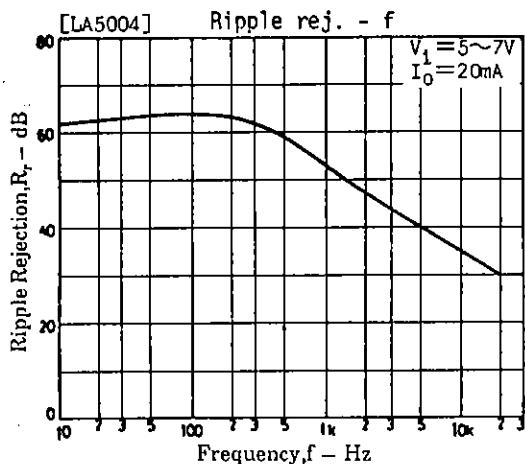

■ No products described or contained herein are intended for use in surgical implants, life-support systems, aerospace equipment, nuclear power control systems, vehicles, disaster/crime-prevention equipment and the like, the failure of which may directly or indirectly cause injury, death or property loss.

■ Anyone purchasing any products described or contained herein for an above-mentioned use shall:

- ① Accept full responsibility and indemnify and defend SANYO ELECTRIC CO., LTD., its affiliates, subsidiaries and distributors and all their officers and employees, jointly and severally, against any and all claims and litigation and all damages, cost and expenses associated with such use;
- ② Not impose any responsibility for any fault or negligence which may be cited in any such claim or litigation on SANYO ELECTRIC CO., LTD., its affiliates, subsidiaries and distributors or any of their officers and employees jointly or severally.

■ Information (including circuit diagrams and circuit parameters) herein is for example only; it is not guaranteed for volume production. SANYO believes information herein is accurate and reliable, but no guarantees are made or implied regarding its use or any infringements of intellectual property rights or other rights of third parties.