

SANYO

No. 3952B

**VHS-format VCR
Video Signal Processor****Overview**

The LA7390N is a single-chip video signal processing IC that is compatible with three systems.

Features

- Compatible with three systems (PAL/MESECAM/4.43-NTSC).
- All filters on chip, except for PB-LPF for chroma (cutoff frequency requires no adjustment).
- No adjustment of YNR and DOC levels.
- Double high-pass noise canceller on chip.
- Linear phase-type picture control on chip.
- fsc output can be used as clock for OSD IC.
- DCC circuit on chip.
- High-speed AFC circuit on chip.
- Smallest package in the industry.
- Few components needed.

Package Dimensions

unit: mm

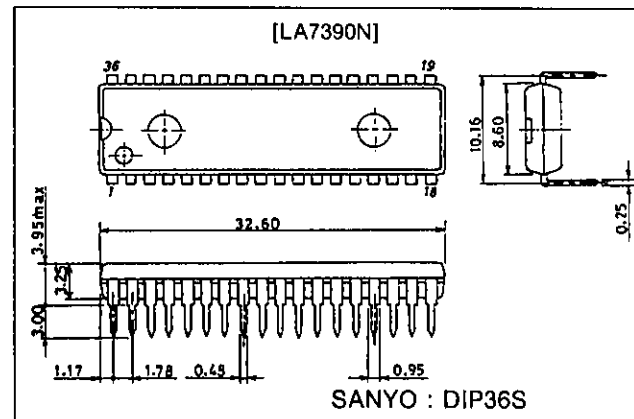
3170-DIP36S**Specifications****Maximum Ratings at Ta = 25°C**

Parameter	Symbol	Conditions	Ratings	Unit
Maximum supply voltage	V _{CCmax}		7.0	V
Allowable power dissipation	P _{dmax}	T _a ≤ 65°C	1070	mW
Operating temperature	T _{opr}		-10 to +65	°C
Storage temperature	T _{stg}		-40 to +150	°C

Operating Conditions at Ta = 25°C

Parameter	Symbol	Conditions	Ratings	Unit
Recommended supply voltage	V _{CC}		5.0	V
Operating supply voltage range	V _{CCop}		4.8 to 5.2	V

LA7390N

Operating Characteristics at Ta = 25°C, VCC = 5.0 V

Parameter	Symbol	Input	Output	Conditions	min	typ	max	Unit
[REC Mode Y]								
Current drain REC	I _{CCR}			When V _{CC} = 5 V (when there is no signal), measure sum of incoming current at pins 24 and 29	95	120	145	mA
AGC adjustment	CAGC	T31A		V _{IN} = 1.0 p-p video signal, use VR33 to adjust T3 output to 0.5 Vp-p				
VCA control characteristics	VCA	T31A	T3	Measure T3 output level when S9 is set to 2	0.48	0.5	0.52	Vp-p
AGC adjustment voltage	V _{AGC}	T31A	T33	Measure T33 DC voltage in above state	3.2	3.4	3.6	V
AGC detection voltage	V _{AD}	T31A	T32	Measure T32 DC voltage in same manner	1.2	1.4	1.6	V
EE output level	V _{EE}	T31A	T28A	Measure T28A output level in same manner	0.92	0.97	1.02	Vp-p
AGC Output 1	AGC 1	T31A	T3	V _{IN} = 2.0 Vp-p video signal Measure T3 output level	500	540	560	mVp-p
AGC Output 2	AGC 2	T31A	T3	V _{IN} = 0.5 Vp-p video signal Measure T3 output level	470	490	500	mVp-p
AGC Output 3	AGC 3	T31A	T3	V _{IN} = 700 mVp-p LUMI, 600 mVp-p SYNC, measure T3 SYNC level	135	150	165	mVp-p
AGC Output 4	AGC 4	T31A	T3	V _{IN} = 700 mVp-p LUMI, 150 mVp-p SYNC, measure T3 SYNC level	70	85	100	mVp-p
Sync separation output level	V _{SYR}	T31A	T26	V _{IN} = 1.0 Vp-p video signal, measure T26 output pulse wave high value	4.0	4.2	4.4	Vp-p
Sync separation output pulse width	PW _{SYR}	T31A	T26	V _{IN} = 1.0 Vp-p video signal, measure T26 output pulse width	4.4	4.7	5.0	μs
Sync separation output leading edge delay time	Δ T _{SYR}	T31A	T26	V _{IN} = 1.0 Vp-p video signal, measure delay time of output SYNC versus input SYNC	0.6	0.8	1.0	μs
Sync separation threshold level	TH _{SYR}	T31A	T26	Gradually attenuate the input level, measure input level at point when output pulse width widens 1 μs or more beyond PWSYR		-18	-14	dB
Sync chip level, pedestal level, white level measurement (REC)	L _{VOR}	T31A	T28	Measure electric potential for each of the T28 video output sync tip, pedestal, and white peak, and assign the measured values to L _{SYN} , L _{PEP} , and L _{WHI} , respectively				
Pseudo V insertion level (REC)	Δ VDR	T31A	T28	Measure T28 DC voltage when 5 V is applied to T27, and assign the measured value to L _{VDR} and calculate the difference with L _{SYN} ΔVDR = L _{SYN} - L _{VDR}	-80	0	+80	mV
Pseudo H insertion level (REC)	Δ HDR	T31A	T28	Measure T28 DC voltage when 2.7 V is applied to T27, and assign the measured value to L _{HDR} and calculate the difference with L _{PEP} ΔHDR = L _{PEP} - L _{HDR}	-200	-100	0	mV
White insertion level (REC)	Δ WHR	T31A	T28	Measure T28 DC voltage when 1.3 V is applied to T27, and assign the measured value to L _{WHR} and calculate the difference with L _{WHI} ΔWHR = L _{WHI} - L _{WHR}	150	250	350	mV
VCA detection voltage	VVCA	T31A	T8	Measure T8 DC voltage	3.1	3.4	3.7	V
REC YNR operation EP/LP	YR-YNR	T31A	T2	V _{IN} = white 50% + CW (15.81 mVp-p) calculate ratio between 32f _H component and 32.5f _H component	3.5	4.5	5.5	dB
Y-LPF frequency characteristics	YLPF1	T31A	T2	V _{IN} = standard multiburst signal 1 Vp-p, measure 2 MHz response to 500 kHz at T2	0.2	0.7	1.2	dB
	YLPF2	T31A	T2	V _{IN} = standard multiburst signal 1 Vp-p, measure 4.8 MHz response to 500 kHz at T2	-4.5	-3.5	-2.5	dB
FM modulator output level	V _{FM}		T34	No Input, use VR36 to adjust output frequency to 4 MHz, measure output level	0.8	1.0	1.2	Vp-p
FM modulator secondary distortion	H _{MOD}		T34	Calculate ratio of 8 MHz component to 4 MHz in the above state		-40	-35	dB
FM modulator modulation sensitivity	S _{MOD}	T3	T34	Measure amplitude of change in output frequency when 2.6 V DC or 3.1 V DC is applied to T3, 2 x (f3.1 - f2.6)	1.6	2.0	2.4	MHz/V

Continued on next page.

LA7390N

Continued from preceding page.

Parameter	Symbol	Input	Output	Conditions	min	typ	max	Unit
FM modulator linearity	L _{MOD}	T3	T34	Measure output frequency when 2.85 V DC applied to T3, $L_{MOD} = \frac{f_{2.85} - (f_{3.1} + f_{2.6}) / 2}{S_{MOD}} \times 100$	-2	0	+2	%
1/2 f _H carrier shift	CS1		T34	Measure amplitude of change in output frequency when SW35B is off and SW35A is switched from on to off	6.8	7.8	9.5	kHz
	CS2		T34	Measure amplitude of change in output frequency when SW35B is on and SW35A is switched from on to off	6.8	7.8	9.5	kHz
Emphasis gain	G _{EMPH}	T3A	T4	V _{IN} = 0.5 Vp-p 10 kHz sine wave Measure ratio of levels of input and output amplitude at T4	-0.5	0	+0.5	dB
Detail enhancer characteristics	GENH1	T3A	T4	V _{IN} = 158 mVp-p 2 MHz sine wave Measure ratio of levels of T4 and T3, calculate difference with G _{EMPH}	0.9	1.4	1.9	dB
	GENH2	T3A	T4	V _{IN} = 50 mVp-p 2 MHz, sine wave Measure ratio of levels of T4 and T3, calculate difference with G _{EMPH}	2.2	3.2	4.2	dB
	GENH3	T3A	T4	V _{IN} = 15.8 mVp-p 2 MHz sine wave Measure ratio of levels of T4 and T3, calculate difference with G _{EMPH}	4.0	5.0	6.0	dB
	GENH4	T3A	T4	V _{IN} = 15.8 mVp-p 2 MHz sine wave Measure output amplitude at T4 in edit mode, calculate difference with G _{EMPH}	1.8	2.8	3.8	dB
Non linear emphasis characteristics	GNLEMP1	T3A	T4	V _{IN} = 500 mVp-p 2 MHz Measure ratio of levels of T4 and T3, calculate difference with G _{EMPH}	0.5	1.4	2.3	dB
	GNLEMP2	T3A	T4	V _{IN} = 158 mVp-p 2 MHz Measure ratio of levels of T4 and T3, calculate difference with G _{EMPH}	2.6	3.8	5.2	dB
	GNLEMP3	T3A	T4	V _{IN} = 50 mVp-p 2 MHz Measure ratio of levels of T4 and T3, calculate difference with G _{EMPH}	4.9	6.4	7.9	dB
Main linear emphasis characteristics	G _{ME1}	T3A	T4	V _{IN} = 50 mVp-p 200 kHz sine wave Measure ratio of levels of T4 and T3, calculate difference with G _{EMPH}	4.9	5.2	5.5	dB
	G _{ME2}	T3A	T4	V _{IN} = 50 mVp-p 2 MHz sine wave Measure ratio of levels of T4 and T3, calculate difference with G _{EMPH}	13.1	13.6	14.1	dB
White clipping level	L _{WC}	T3A	T4	V _{IN} = 500 mVp-p white 100% video signal Measure white clipping level at T4	186	193	200	%
Dark clipping level	L _{DC}	T3A	T4	V _{IN} = 500 mVp-p white 100% video signal Measure dark clipping level at T4	-60	-55	-50	%
[PB Mode Y]								
Current drain PB	I _{ccP}			Incoming current at pins 24 and 29 when V _{CC} = 5.0 V	125	155	185	mA
Dropout compensation period	T _{DOC}	T33A T3A	T28A	T33A: 4 MHz, 300 mVp-p sine wave T3A: 0.5 Vp-p video signal T28A: time from when input went to 0 until T28A output returned, SW9 → 1	0.35	0.5	0.65	ms
DOC loop gain	G _{DOC}	T33A T3A	T11	T33A: 4 MHz, 300 mVp-p sine wave T3A: 0.5 Vp-p video signal T33A: Input/output response when 5H have elapsed after input went to 0, SW9 → 3	-1.0	0	+1.0	dB
FM demodulation voltage	V _{DEM4}	T33A	T2	V _{IN} = 300 mVp-p, f = 4 MHz, Output DC Voltage	1.5	2.0	2.5	V
FM demodulation sensitivity	S _{DEM}	T33A	T2	V _{IN} = 300 mVp-p, f = 2 MHz, V _{DEM2} V _{IN} = 300 mVp-p, f = 6 MHz, V _{DEM6} Calculate S _{DEM} = (V _{DEM6} - V _{DEM2})/4	0.36	0.45	0.54	V/MHz
FM demodulation linearity	L _{DEM}	$L_{DEM} = \frac{V_{DEM4} - (V_{DEM6} + V_{DEM2})/2}{V_{DEM6} - V_{DEM2}} \times 100$		-3.5	0	+3.5	%	

Continued on next page.

LA7390N

Continued from preceding page.

Parameter	Symbol	Input	Output	Conditions	min	typ	max	Unit
Carrier leak	CL	T33A	T2	$V_{IN} = 300 \text{ mVp-p}$, $f = 4 \text{ MHz}$ Ratio between 4 MHz component of T2 and S_{DEM}		-40	-35	dB
PB YNR characteristics LP/EP	GP-YNR	T3A	T24A	$V_{IN} = \text{white } 50\% + \text{CW } (15.8 \text{ mVp-p})$ Ratio between $32f_H$ component and $32.5f_H$ component	-11	-9	-7	dB
PB LNC characteristics SP	GP-LNC	T3A	T24A	$V_{IN} = \text{white } 50\% + \text{CW } (15.8 \text{ mVp-p})$ Ratio between $32f_H$ component and $32.5f_H$ component	-12	-10	-8	dB
Playback through gain	G_{PB}	T3A	T28A	Apply $V_{IN} = 0.5 \text{ Vp-p}$ video signal to pin 3, and determine ratio between T28A output level and input level	4.0	5.5	7.0	dB
Nonlinear de-emphasis characteristics	$G_{NL-DEEM1}$	T3A	T28A	$V_{IN} = \text{white } 50\% + \text{CW}$ $f = 1 \text{ MHz}$, measure input/output response, difference with 158 mVp-p , G_{PB}	-2.8	-1.8	-0.8	dB
	$G_{NL-DEEM2}$	T3A	T28A	$f = 1 \text{ MHz}$, 50 mVp-p	-5.0	-4.0	-3.0	dB
Noise canceller characteristics	G_{WNC1}	T3A	T28A	$f = 1.5 \text{ MHz}$, 158 mVp-p	-1.3	-0.8	-0.3	dB
	G_{WNC2}	T3A	T28A	$f = 1.5 \text{ MHz}$, 50 mVp-p	-5.0	-4.0	-3.0	dB
	G_{WNC3}	T3A	T28A	$f = 1.5 \text{ MHz}$, 15.8 mVp-p	-14.0	-12.0	-10.0	dB
PIC-CTL center response characteristics	G_{PC}	T3A	T28A	$f = 2 \text{ MHz}$, 158 mVp-p	1.2	1.7	2.2	dB
PIC-CTL hard response characteristics	G_{PH}	T3A	T28A	$f = 2 \text{ MHz}$, 158 mVp-p	7.0	8.0	10.0	dB
PIC-CTL soft response characteristics	G_{PS}	T3A	T28A	$f = 2 \text{ MHz}$, 158 mVp-p	-10.0	-8.0	-7.0	dB
Sync tip level, pedestal level, white level measurement (PB)	L_{VOR}	T3A	T28A	With $V_{IN} = \text{white } 100\%$ and T28A at 1.0 Vp-p , measure electric potential for each of the pin 28 video output sync tip, pedestal, and white peak, and assign the measured values to L_{SYN} , L_{PED} , and L_{WHI} , respectively				
Pseudo V insertion level (PB)	ΔVDP	T3A	T28	Measure pin 28 DC voltage when 5 V is applied to pin 27, and assign the measured value to L_{VDP} , and calculate the difference with L_{SYN} $\Delta VDP = L_{SYN} - L_{VDP}$	-80	0	+80	mV
Pseudo H insertion level (PB)	ΔHDP	T3A	T28	Measure pin 28 DC voltage when 2.7 V is applied to pin 27, and assign the measured value to L_{HDP} , and calculate the difference with L_{PED} $\Delta HDP = L_{PED} - L_{HDP}$	-300	-200	-100	mV
White insertion level (PB)	WHP	T3A	T28	Measure pin 28 DC voltage when 1.3 V is applied to pin 27, and assign the measured value to L_{WHP} , and calculate the difference with L_{WHI} $\Delta WHP = L_{WHI} - L_{WHP}$	20	120	220	mV
Sync separation output level	V_{SYP}	T3A	T26	$V_{IN} = 0.5 \text{ Vp-p}$ video signal, pin 26 output pulse wave high value	4.0	4.2	4.4	Vp-p
Sync separation output pulse width	PW_{SYP}	T3A	T26	$V_{IN} = 0.5 \text{ Vp-p}$ video signal, pin 26 output pulse width	4.4	4.7	5.0	μs
Sync separation output leading edge delay time	ΔT_{SYP}	T3A	T26	$V_{IN} = 0.5 \text{ Vp-p}$ video signal, measure delay time of output SYNC versus input SYNC	0.9	1.1	1.3	μs
4.2 V regulator operation check	V_{REG}		T25	Measure DC level of T25 in REC mode	3.95	4.15	4.35	VDC
[REC Mode Chroma]								
REC Chroma low-band conversion output level	V_{OR-14}	T31A	T14A	$V_{IN} = \text{standard color bar signal } (1 \text{ Vp-p})$ Measure burst level at T14A	120	160	200	mVp-p
VXO oscillation level	V_{VXO-R}	T31A	T18	$V_{IN} = \text{standard color bar signal } (1 \text{ Vp-p})$, measure T18 output amplitude (with a FET probe)	450	560	670	mVp-p

Continued on next page.

LA7390N

Continued from preceding page.

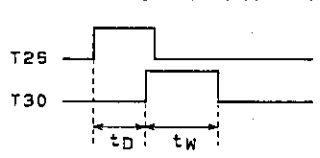
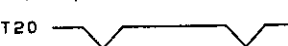
Parameter	Symbol	Input	Output	Conditions	min	typ	max	Unit
REC ACC characteristics	ACC _{R1}	T31A	T14A	V _{IN} = standard color bar signal (1 Vp-p), input +6 dB chroma signal level, measure T14A burst level, and calculate ratio with V _{OR-14}		+0.2	+0.5	dB
	ACC _{R2}	T31A	T14A	V _{IN} = standard color bar signal (1 Vp-p), input -6 dB chroma signal level, measure T14A burst level, and calculate ratio with V _{OR-14}	-0.5	-0.1		dB
REC ACC killer input level	V _{ACK-ON}	T31A	T14A	V _{IN} = standard color bar signal (1 Vp-p), lower the chroma signal, and measure the input burst level at the point where output at T14A stops, and calculate the ratio with the standard input level.		-26		dB
REC ACC killer output level	V _{ACK}	T31A	T14A	Use a spectrum analyzer to measure the output level at T14A in the killer state described previously; ratio with V _{OR-14}		-60	-50	dB
Input level for REC ACC killer return	V _{ACK-OFF}	T31A	T14A	Starting from the killer state described previously, gradually raise the input chroma level and measure the input burst level when output is generated at T14A and calculate the ratio with the standard input level		-20		dB
VXO measurement sensitivity	S _{VXO}	T31A	T16 T18A	Measure the pin 16 DC voltage when a standard color bar signal is input (1 Vp-p)...V ₀ Measure the frequency at T18A when V ₀ is applied to pin 16 from the external power supply...f ₁ Measure the frequency at T18A when V ₀ + 10 mV is applied to pin 16...f ₂ $S_{VXO} = \frac{f_2 - f_1}{10} \text{ Hz/mV}$	3.8	5.7	7.6	Hz/mV
REC APC pull-in range	Δf _{APC1}	T31A	T14A	Input a 50% white signal overlapped with a 4.4336 MHz, 300 mVp-p continuous wave. After confirming that there is output at T14A, increase the frequency of the CW until the output at T14A stops, and then gradually reduce the frequency until output appears again at T14A; that CW frequency is f ₁ . Δf _{APC1} = f ₁ - 4433619 (Hz)	350	440		Hz
	Δf _{APC2}	T31A	T14A	In the same manner, reduce the frequency of the CW until the output at T14A stops, then gradually increase the frequency until output appears again at T14A; that frequency is f ₂ . Δf _{APC2} = f ₂ - 4433619 (Hz)		-900	-350	Hz
BGP delay time	t _D	T31A	T26 T30	Measure waveforms at T26 and T30 when a standard color bar signal (1 Vp-p) is input.		4.3		μs
BGP pulse width	t _w	T31A	T26 T30			4.8		μs
REC AFC pull-in range	Δf _{AFC1}	T31A	T20	Input a string of pulses (negative polarity) at 300 mV, 15.6 kHz with a width of 5 μs. After increasing the frequency of the pulse string until the waveform at pin 20 is disrupted, then reduce the frequency until the waveform at pin 20 is normal again; that pulse string frequency is f ₁ .  Δf _{AFC1} = f ₁ - 15.625 (kHz)	1.0	7.0		kHz

Continued on next page.

LA7390N

Continued from preceding page.

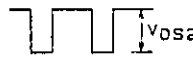
Parameter	Symbol	Input	Output	Conditions	Min	Typ	Max	Unit
REC AFC pull-in range	Δf_{AFC2}	T31A	T20	In the same manner, after reducing the frequency of the pulse string until the waveform at pin 20 is disrupted, then increase the frequency until the waveform at pin 20 is normal again; that pulse string frequency is f_2 . $\Delta f_{AFC2} = f_2 - 15.625$ (kHz)		-3.7	-1.0	kHz
[PB Mode Chroma]								
PB chroma video output level	V_{op-28}	T33A T14A T3A	T28A	In PB, SP modes, input a 4 MHz: 300 mVp-p continuous wave at T33A, and from T14A input a chroma signal (SP mode, burst 50 mVp-p) that underwent low-band conversion from a chroma noise test signal. Input a 50% white signal from T4A and measure the T28A burst level.	240	300	360	mVp-p
PB ACC characteristics	ACC_{p1}	T33A T14A T3A	T28A	Input the input chroma level at +6 dB under the same conditions as for V_{op-28} and measure the T28A burst level, and calculate the ratio with V_{op-28} .		0.5	0.8	dB
	ACC_{p2}	T33A T14A T3A	T28A	Input the input chroma level at -6 dB under the same conditions as for V_{op-28} and measure the T28A burst level, and calculate the ratio with V_{op-28} .	-0.5	-0.2		dB
PB killer input level	V_{ACK-P}	T33A T14A T3A	T28A	Lower the input chroma level under the same conditions as for V_{op-28} and measure the input burst level at the point where T28A chroma output ceases. (Calculate ratio with standard input of 50 mVp-p.)	-40	-32	-25	dB
PB killer chroma output level	V_{OACK-P}	T33A T14A T3A	T28A	Use a spectrum analyzer to measure the T28A chroma output level in the killer state described previously. Calculate ratio with V_{op-28} .		-44	-40	dB
PB main converter carrier leak	C_{LP}	T33A T14A T3A	T28A	Monitor T28A with a spectrum analyzer under the same conditions as for V_{op-28} and calculate the ratio between the 4.43 MHz component and the 5.06 MHz carrier leak component.		-40	-33	dB
PB XO output level	V_{XO-P}		T18	Measure the PB mode T18 output level with an FET probe.	480	610	750	mVp-p
PB XO oscillation frequency variation	Δf_{XO}		T18A	Measure the frequency at T18A during PB mode...f $\Delta f_{XO} = f - 4433619$ (Hz)	-9	0	+9	Hz
SLD detection current	I_{SLD1}	T33A T3A	T19A	In PB mode, with S20:3 and S19:off, input a 4 MHz 300 mVp-p continuous wave from T33A, input a 50% white signal from T4A, and measure the wave peak at T19A.  $I_{SLD1} = V_{OS1}/1 \text{ k}\Omega$		135		μA
	I_{SLD2}	T33A T3A	T19A	Same as above (however, S20 = 1)  $I_{SLD2} = V_{OS2}/1 \text{ k}\Omega$		135		μA
2fsc output level	V_{2fsc}		T35A	In PB mode, measure the T35A output level with an FET probe.	490	690	890	mVp-p

Note) A trap is required in the chroma playback system (between pins 21 and 23) in order to suppress unnecessary components (5.69 MHz) in converter output.

LA7390N

Equivalent Circuit Block Diagram and Sample Application Circuit

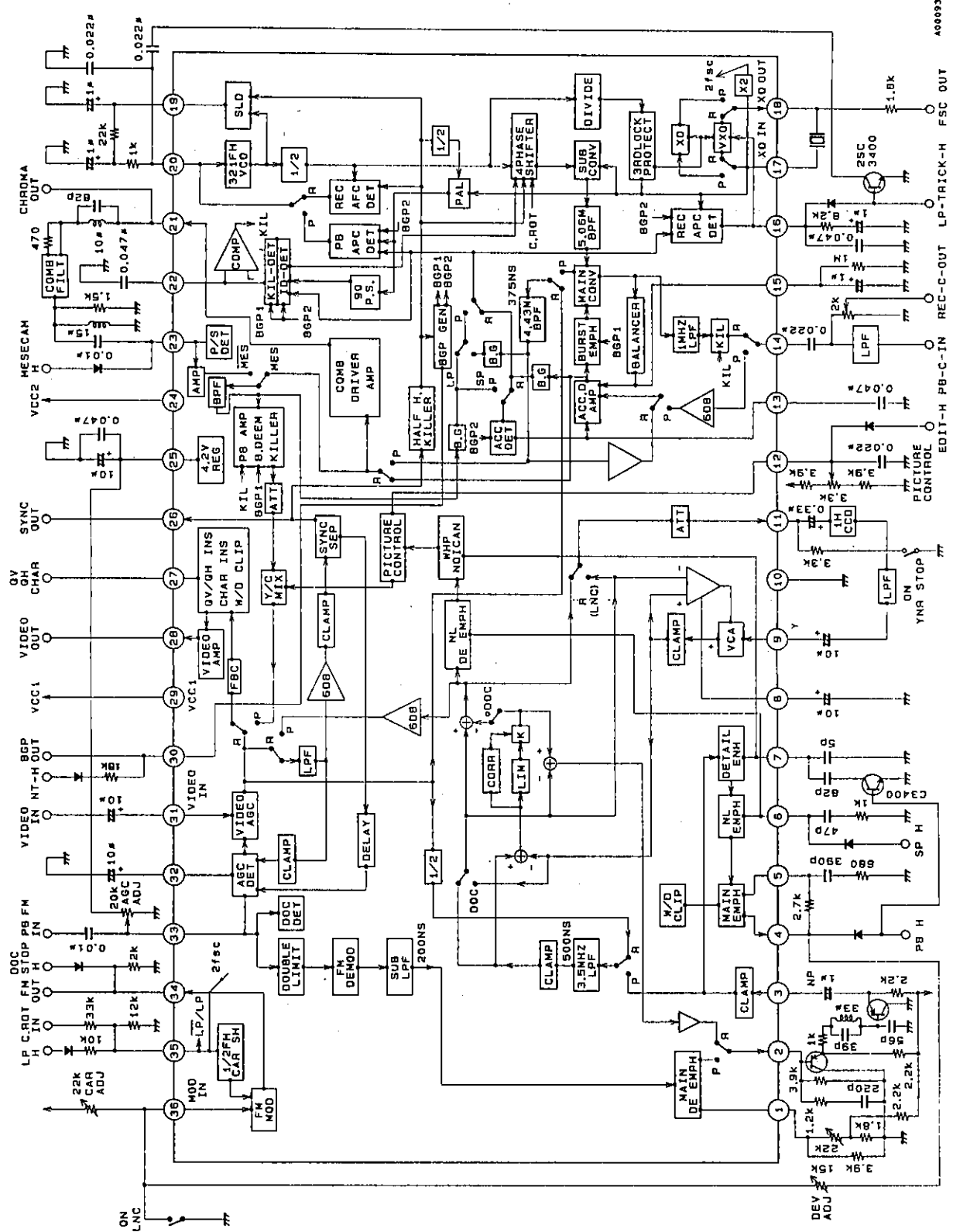

A00093

Unit (resistance: Ω, capacitance: F)

LA7390N

Control Pin Function Chart

Pin No.	L	M	H
Pin 4 R/P switching	Open REC mode		Over 3.8 V PB mode
Pin 6 SP/EP switching	Open EP mode		Over 3.9 V SP mode
Pin 12 EDIT2 PIC-CTL	2 V to 2.5 V PIC-CTL SOFT	2.5 V to 3 V PIC-CTL HARD	Over 3.6 V EDIT ON
Pin 13 SECAM CTL			Over 4.0 V SECAM mode
Pin 16 Special playback switching		Open Before comb in SP	Over 3.5 V (over 200 μ A) After comb in SP
Pin 23 MESECAM CTL		Open	Over 3.0 V MESECAM mode
Pin 27 QV, QH, CHAR		Refer to pin 27, QV, QH, CHAR, insertion diagram	
Pin 30 NTSC CTL			NTSC mode when current flow is over 150 μ A
Pin 34 DOC STOP control	Open Normal mode		Over 3.9 V DOC STOP
Pin 35 ROTARY pulse LP switching			
Pin 36 YNR/LNC switching	Line NC when under 1 V In PB	Open SP: LNC, LP/EP: YNR	

Pin 27
QV, QH, CHAR, insertion

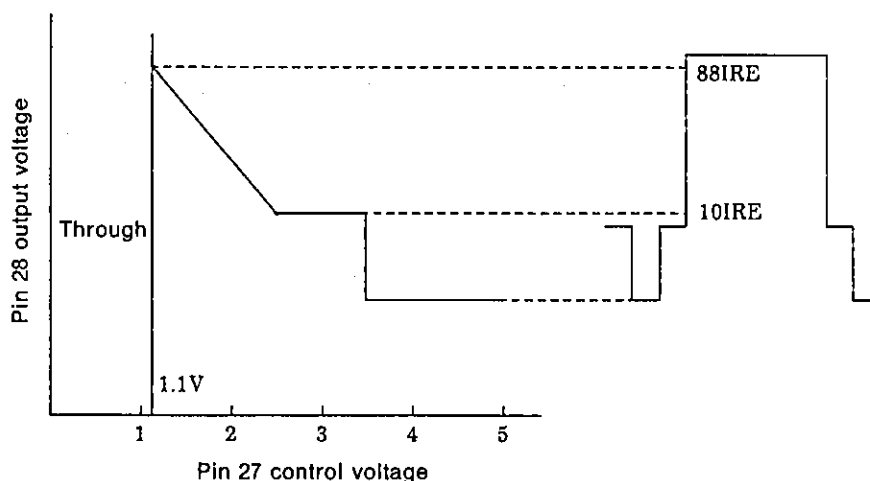

- No products described or contained herein are intended for use in surgical implants, life-support systems, aerospace equipment, nuclear power control systems, vehicles, disaster/crime-prevention equipment and the like, the failure of which may directly or indirectly cause injury, death or property loss.
- Anyone purchasing any products described or contained herein for an above-mentioned use shall:
 - ① Accept full responsibility and indemnify and defend SANYO ELECTRIC CO., LTD., its affiliates, subsidiaries and distributors and all their officers and employees, jointly and severally, against any and all claims and litigation and all damages, cost and expenses associated with such use:
 - ② Not impose any responsibility for any fault or negligence which may be cited in any such claim or litigation on SANYO ELECTRIC CO., LTD., its affiliates, subsidiaries and distributors or any of their officers and employees jointly or severally.
- Information (including circuit diagrams and circuit parameters) herein is for example only; it is not guaranteed for volume production. SANYO believes information herein is accurate and reliable, but no guarantees are made or implied regarding its use or any infringements of intellectual property rights or other rights of third parties.

This catalog provides information as of May, 1995. Specifications and information herein are subject to change without notice.