

SANYO

No.3315

LA7855, 7856**Very High Resolution
CRT Display Synchronization****Overview**

The LA7855, 7856 are sync-deflection circuit ICs dedicated to CRT display use. They can be connected to the LA7837, 7838 (for vertical output use) to form a sync-deflection circuit that meets every requirement for CRT display use.

The LA7855, 7856 are performance-improved versions of the existing LA7850, 7851. The LA7855, 7856 are intended for use in very high-definition display ($f_H = 64$ to 150kHz) applications. When the horizontal frequency exceeds approximately 64kHz , problems are experienced with horizontal jitter which has been less of a problem in low-frequency display applications. The newly developed LA7855, 7856, which are fabricated with a special production process, are capable of suppressing horizontal jitter components successfully (30% reduced as compared with our existing similar Type Nos.). The LA7855, 7856 are ideally suited for use in high performance-required applications.

The LA7855, 7856 are pin-compatible with the LA7850, 7851, respectively. The LA7855, 7856 are different in the vertical sync pull-in range (LA7855 : 10Hz , LA7856 : 20Hz).

Features

- The horizontal oscillation frequency can be adjusted stably from 15kHz to 150kHz .
- The horizontal display can be shifted right/left.
- The horizontal/vertical sync input can be used intact regardless of the difference in pulse polarity and pulse width.
- The AFC feedback sawtooth wave can be obtained by simply applying a flyback pulse to the IC as a trigger pulse.
- Any duty of the horizontal pulse can be set.
- The LA7855, 7856 can be connected to the LA7837, 7838 to develop pictures with the interlace characteristics, crossover distortion characteristics improved.

On-Chip Functions**[Horizontal Block]**

- Horizontal sync input
- Horizontal phase shift
- AFC sawtooth wave generator
- Horizontal pulse duty setting
- Horizontal OSC
- AFC
- X-ray protector

[Vertical Block]

- Vertical trigger input
- Vertical OSC
- Vertical sawtooth wave generator
- Sampling type DC voltage control

Package Dimensions

(unit : mm)

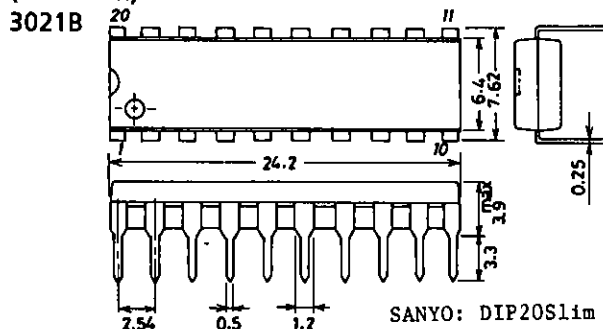

LA7855, 7856

Maximum Ratings at Ta = 25°C				unit	
Maximum Supply Voltage	V ₁₀ , V ₂₀ max		14	V	
Allowable Power Dissipation	Pd max	Ta ≤ 65°C	780	mW	
Operating Temperature	Topr		-20 to +85	°C	
Storage Temperature	Tstg		-55 to +125	°C	
Operating Conditions at Ta = 25°C				unit	
Recommended Supply Voltage	V ₁₀ , V ₂₀		12	V	
Operating Voltage Range	V ₁₀ , V ₂₀ op		9 to 13.5	V	
Recommended Vertical Pulse Input Peak Value	V _{pulse}		5	Vp-p	
Operating Vertical Pulse Input Peak Value Range	V _{pulse}		2 to 6	Vp-p	
Recommended Horizontal Pulse Input Peak Value	H _{pulse}		5	Vp-p	
Operating Horizontal Pulse Input Peak Value Range	H _{pulse}		2 to 6	Vp-p	
Operating Characteristics at Ta = 25°C, V ₁₀ , V ₂₀ = 12V				min typ max unit	
V _{CC10} Current Dissipation	I ₁₀		12	30	mA
V _{CC20} Current Dissipation	I ₂₀		5	12	mA
Vertical Frequency Pull-in Range	V _{pIN}	Vertical sync 60Hz () : LA7856	10.0 (21.0)	12.0 (23.0)	Hz
Vertical Free-running Frequency	f _v	f _v center 55Hz	50	60	Hz
Increased/Reduced Voltage Characteristic of Vertical Frequency	Δf _{v.V}	V ₂₀ = 12 ± 1V, 55Hz at 12V	-0.1	0.1	Hz
Midpoint Control Threshold Level			3.8	4.4	V
Vertical OSC Start Voltage	f _{v.st}			4.0	V
Temperature Characteristic of Vertical Frequency		Ta = -10 to +60°C	-0.028	0.028	Hz/°C
Vertical Driver Amplification Factor	G _v		12	18	dB
Horizontal AFC DC Loop Gain	I _{AFC}		±0.85	±1.6	mA
Horizontal Free-running Frequency	f _H	f _H center 15.734kHz	-750	750	Hz
Horizontal OSC Start Voltage	f _{H.st}			4.0	V
Increased/Reduced Voltage Characteristic of Horizontal Frequency	ΔH.V	V ₁₀ = 12 ± 1V, 15.734kHz at 12V	-50	50	Hz
Horizontal OSC Warm-up Drift	Δf _H	5s. to 30min. after application of power	-50	50	Hz
Temperature Characteristic of Horizontal Frequency		Ta = -10 to +60°C	-2.9	2.9	Hz/°C
Horizontal Output Drive Current	I ₁₂		6.0	12.0	mA
Increased/Reduced Voltage Characteristic of Phase Shifter Delay Time		V ₁₀ = 12 ± 1V	-0.5	0.5	%/V
Temperature Characteristic of Phase Shifter Delay Time		Ta = -10 to +60°C	-0.1	0.1	%/°C
Increased/Reduced Voltage Characteristic of Phase Shifter Pulse Width		V ₁₀ = 12 ± 1V	-1.0	1.0	%/V
Temperature Characteristic of Phase Shifter Pulse Width		Ta = -10 to +60°C	-0.13	0.13	%/°C
AFC Phase Comparison Center Time		15.734kHz after F.B.P. input	9.9	11.5	μs
Increased/Reduced Voltage Characteristic of AFC Phase Comparison Center Time		V ₁₀ = 12 ± 1V	-1.5	1.5	%/V
Temperature Characteristic of AFC Phase Comparison Center Time		Ta = -10 to +60°C	-0.2	0.2	%/°C
Comparison Waveform Generating Input Operation Voltage	V ₄		0.65	0.95	V
Pin 13 Voltage at Hold-down Operation Start	V ₁₃		0.55	0.85	V

LA7855, 7856

Correspondence with the Existing IC Series

- LA7850 ————> LA7855
- LA7851 ————> LA7856
- LA7852 ————> LA7857
- LA7853 ————> LA7858

Type No.	Package	Vertical Pull-in Range	GND Pin
LA7850, 7855	DIP-20S	10Hz (at 60Hz)	Common to horizontal/vertical
LA7851, 7856	DIP-20S	20Hz (at 60Hz)	Common to horizontal/vertical
LA7852, 7857	DIP-22S	10Hz (at 60Hz)	Separated for horizontal/vertical
LA7853, 7858	DIP-22S	20Hz (at 60Hz)	Separated for horizontal/vertical

Equivalent Circuit Block Diagram

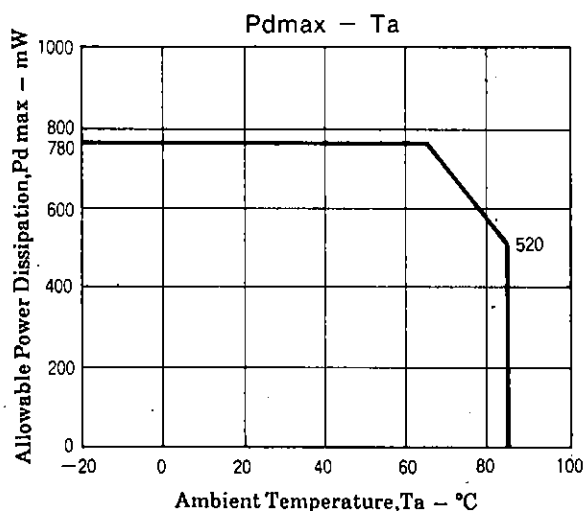
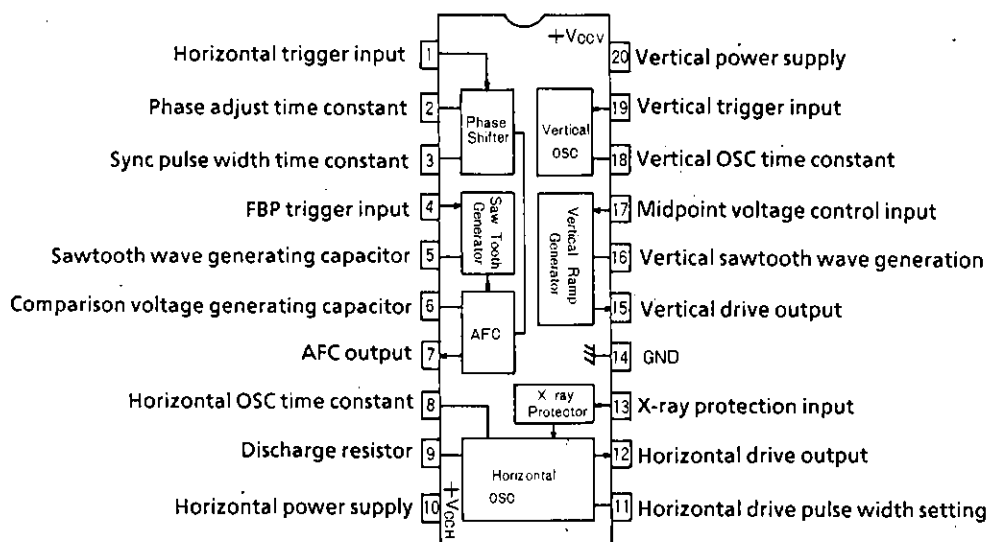

LA7855, 7856

Sample Application Circuit : 14" monitor

Vertical retrace time $\leq 700\mu\text{s}$

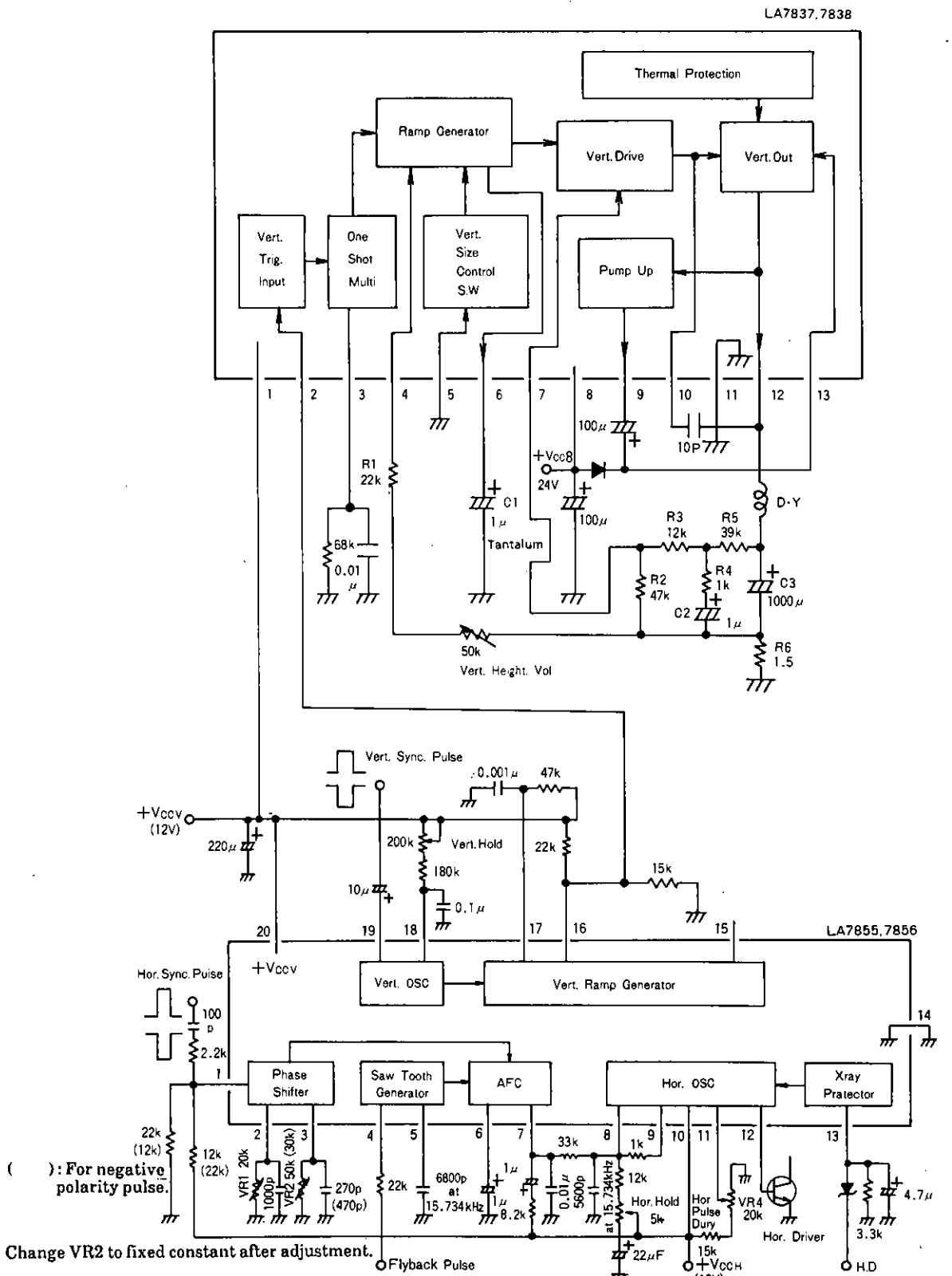

Unit (resistance: Ω , capacitance:F)

Fig.1

LA7855, 7856

Sample Application Circuit: 14" display

Vertical retrace time $\approx 300\mu\text{s}$

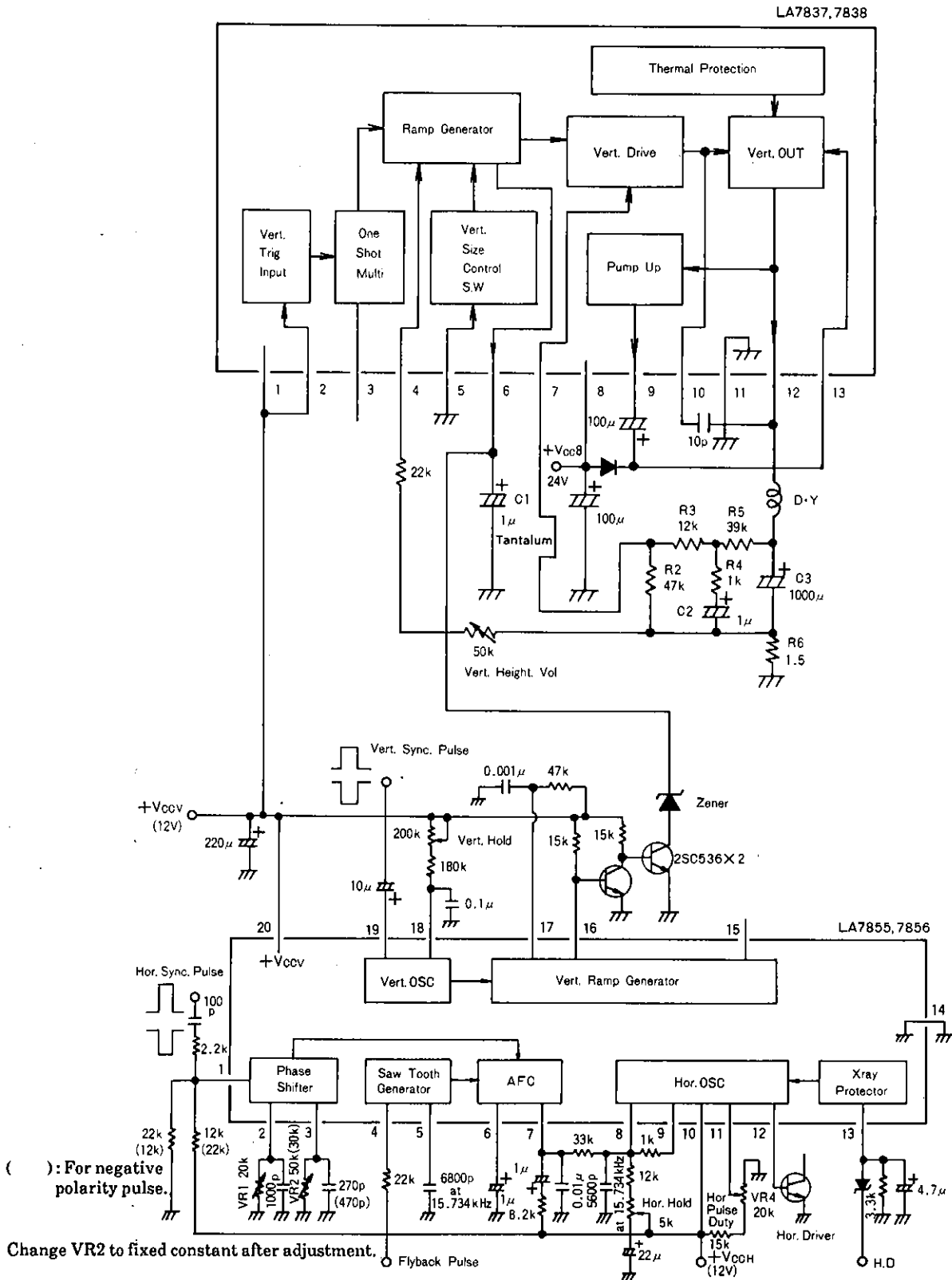

Unit (resistance: Ω , capacitance:F)

Fig.2

Precautions when using with vertical output ICs LA7837, 7838 :

The vertical output ICs LA7837,7838 are appropriate for use in monitors and displays because the interlace and crossover distortion responses are superior to those of the LA7835,7836.

However, since the vertical retrace time of displays is shorter than that of TV, the upper portion of the vertical picture may stretch. This is because the start waveform of the pin 6 sawtooth wave bends, as shown in Fig.3, due to the diode response of the clamp waveform. If there is not much time difference between T_1 and T_R , the upper portion of the vertical picture will tend to stretch. The use of a circuit as shown in Fig.2 will cause pin 6 waveform start wave to become linear, so that stretching is suppressed.

The example of circuit application shown in Fig.2 does not use the trigger input circuit (pin 2) and one-shot multivibrator (pin 3) built in the LA7837,7838 ; the pin 6 sawtooth wave is controlled by the LA7855,7856 vertical output pulse.

Therefore, the discharge circuit and clamp circuit are formed by the external Zener diode and transistor TR2.

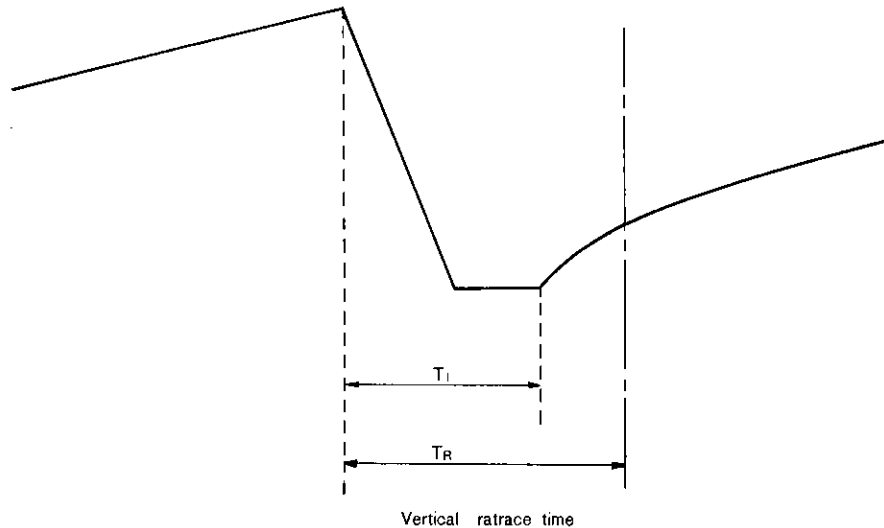

Fig.3

Design Example

For 12V pin 1 power supply

On the LA7837,7838, pin 3 one-shot multivibrator operates when a trigger pulse enters pin 2. During this time, the sawtooth wave generator discharge circuit and clamp circuit inside pin 6 operate.

The clamp voltage at this time is figured according to this formula :

$$V_{CLAMP} = 5/12 \cdot V_{CC} \dots\dots\dots \textcircled{1}$$

For 12V,

$$V_{CLAMP} = 5 [V]$$

Therefore, the Zener diode used in Fig.2 must be rated more than 5V (e.g. 5.6V), otherwise the clamp circuit inside the IC will operate.

For 9V pin 1 power supply

The same as for 12V, according to formula $\textcircled{1}$:

$$V_{CLAMP} = 3.75 [V]$$

So, the Zener diode must be rated more than 4V (e.g. 4.5V).

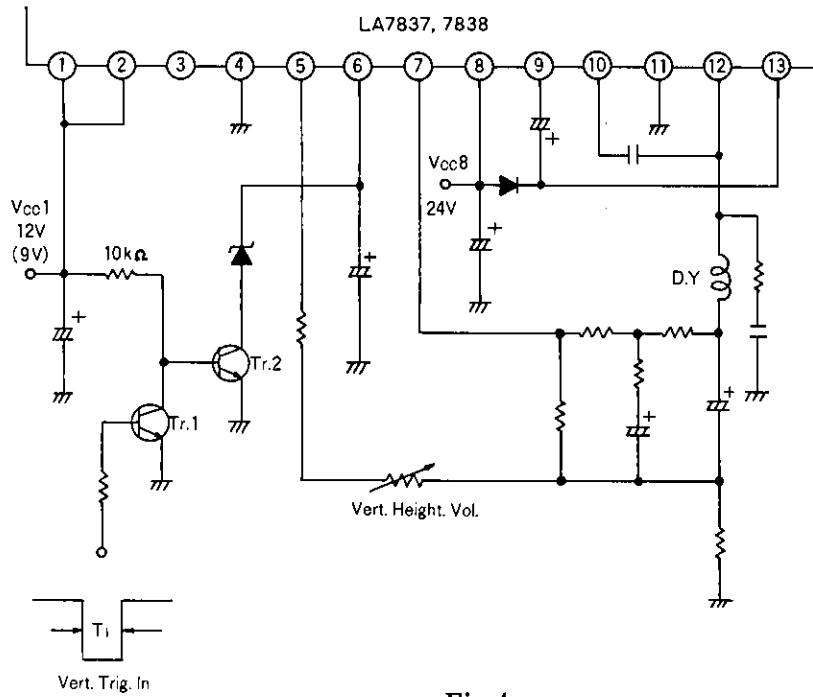
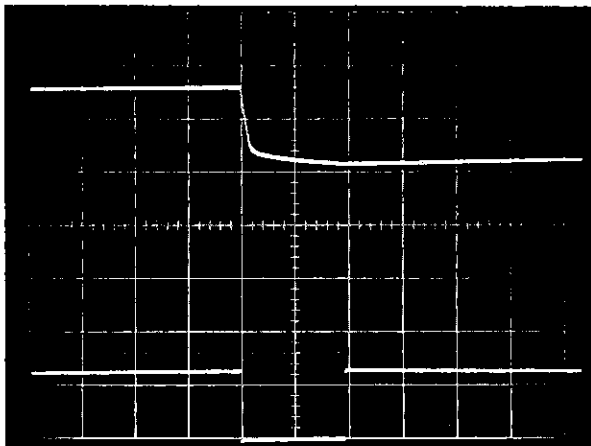

Fig.4

Pin 6 waveform when using the LA7837,7838 in a display application circuit (Fig.2)



Pin 6 waveform 1 [V/div]
Horizontal: 100 [μs]

LA7855,7856 pin 16 waveform
0.5 [V/div]

0 V

Fig.5

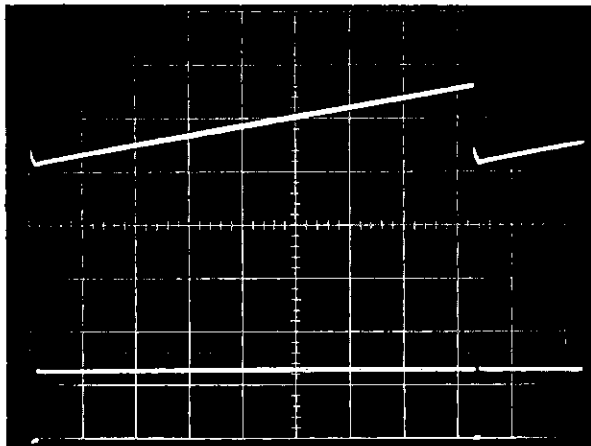

Pin 6 waveform 1 [V/div]
Horizontal: 2 [ms]

LA7855,7856 pin 16 waveform
0.5 [V/div]

0 V

- No products described or contained herein are intended for use in surgical implants, life-support systems, aerospace equipment, nuclear power control systems, vehicles, disaster/crime-prevention equipment and the like, the failure of which may directly or indirectly cause injury, death or property loss.
- Anyone purchasing any products described or contained herein for an above-mentioned use shall:
 - ① Accept full responsibility and indemnify and defend SANYO ELECTRIC CO., LTD., its affiliates, subsidiaries and distributors and all their officers and employees, jointly and severally, against any and all claims and litigation and all damages, cost and expenses associated with such use:
 - ② Not impose any responsibility for any fault or negligence which may be cited in any such claim or litigation on SANYO ELECTRIC CO., LTD., its affiliates, subsidiaries and distributors or any of their officers and employees jointly or severally.
- Information (including circuit diagrams and circuit parameters) herein is for example only; it is not guaranteed for volume production. SANYO believes information herein is accurate and reliable, but no guarantees are made or implied regarding its use or any infringements of intellectual property rights or other rights of third parties.

This catalog provides information as of **June , 1996** . Specifications and information herein are subject to change without notice.